

# T3DSO1000 Digital Oscilloscope Quick Start Guide

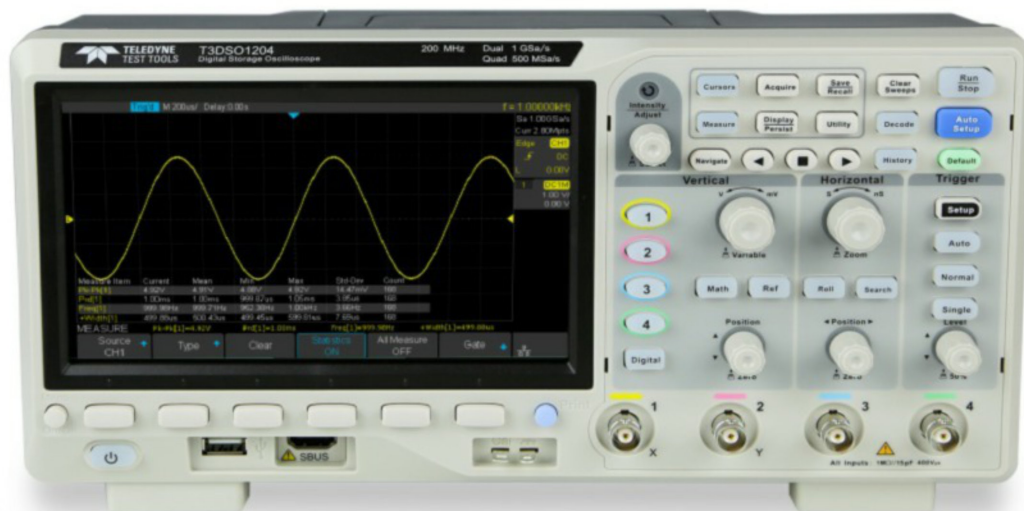

---

# Contents

<b>General Safety Summary</b> .....	1
<b>Daily Maintenance and Cleaning</b> .....	3
<b>General Inspection</b> .....	4
<b>Size and Adjustments</b> .....	5
<b>Connecting to AC Power</b> .....	6
<b>Connecting and Compensating Probes</b> .....	6
<b>Front and Rear Panels</b> .....	8
<b>Front Panel Operation</b> .....	10
<b>Display Overview</b> .....	18
<b>Troubleshooting</b> .....	20

© 2018 Teledyne LeCroy, Inc. All rights reserved.

Teledyne Test Tools is a brand and trademark of Teledyne LeCroy, Inc. Other product or brand names are trademarks or requested trademarks of their respective holders. Specifications, prices, availability and delivery subject to change without notice.

---

---

# General Safety Summary

Read the following precautions carefully to avoid any personal injuries, or damage to the instrument or products connected to it. Use the instrument only as specified.

**Use only the power cord supplied for the instrument.**

**Ground the instrument.** The instrument is grounded through the ground conductor of the power cord. To avoid electric shock, always connect to grounded outlets. Make sure the instrument is grounded correctly before connecting its input or output terminals.

**Connect the signal wire correctly.** To avoid damage, observe input polarity and maximum voltage/current ratings at all times.

**Observe all terminal ratings and signs on the instrument to avoid fire or electric shock.** Before connecting to the instrument, read the manual to understand the input/output ratings.

**Do not operate with suspected failures.** If you suspect that the instrument is damaged, contact the Teledyne LeCroy service department immediately.

**Do not operate in wet/damp conditions.**

**Do not operate in an explosive atmosphere.**

**Keep the surface of the instrument clean and dry.**

**Avoid touching exposed circuits or wires.** Do not touch exposed contacts or components when the power is on.

**Do not operate without covers.** Do not operate the instrument with covers or panels removed.

**Use only the fuse specified for the instrument.**

**Use proper over voltage protection.**

**Use anti-static protection.** Operate in an anti-static protected area. Ground measurement cable conductors before connecting to the instrument to discharge any static electricity before connecting the cables to the instrument.

**Observe ventilation requirements.** Ensure good ventilation. Check the vent and fan regularly to prevent overheating.

---

## Safety Terms and Symbols

The following terms may appear on the instrument:

**DANGER:** Direct injury or hazard may occur.

**WARNING:** Potential injury or hazard may occur.

**CAUTION:** Potential damage to instrument/property may occur.

The following symbols may appear on the instrument:



**CAUTION**  
Risk of injury or damage. Refer to manual.

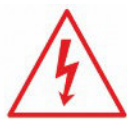

**WARNING**  
Risk of electric shock or burn



Earth Ground Terminal



Protective Conductor Terminal



Frame or Chassis Terminal



ON/Standby Power



Alternating Current

## Measuring Terminal Ratings

**Max. Input Voltage:**  $1\text{ M}\Omega \leq 400\text{ Vpk}$  (DC + Peak AC  $\leq 10\text{ KHz}$ )

**Derated Voltage:** 400 Vmax to 10 KHz, derating at 20 dB/decade to 10 Vmax at 400 KHz

**No rated measurement category (CAT)** per IEC/EN 61010-031:2015. Measuring terminals on this product are not intended to be connected directly to mains.

## Operating Environment

**Temperature:** 10 °C to 40 °C

**Relative Humidity:** 85% RH at 40 °C for up to 24 hours

**Altitude:**  $\leq 3000\text{ m}$

**Use indoors only.**

**Pollution Degree 2.** Use in an operating environment where normally only dry, non-conductive pollution occurs. Temporary conductivity caused by condensation should be expected.

---

## AC Power

**Input Voltage & Frequency:** 100-120 V at 400 Hz or  
100-240 V at 50/60 Hz

**Automatic AC selection.**

**Power Consumption:** 50 W maximum

**Mains Supply Connector:** CAT II per IEC/EN 61010-1:2010,  
instrument intended to be supplied from the building wiring at  
utilization points (socket outlets and similar).

## Fuse Type

1.25 A / 250 V "T" rated 5x20 mm

# Daily Maintenance and Cleaning

## Maintenance

Protect the liquid crystal display from direct sunlight when storing or using the instrument.

### NOTE:

To avoid damage to the instrument or test leads, do not place them in mist, liquid or solvent.

## Cleaning

Regularly clean the instrument and test leads.

- Wipe the external dust off the instrument and test leads using a damp soft rag. Be careful not to scratch the display screen when cleaning. Do not allow any liquid to enter the instrument.
- Use a 75% isopropyl alcohol/water solution when a more thorough cleaning is necessary.

### NOTE:

To prevent damage to the surface of the instrument or test leads, do not use any corrosive or chemical cleaning agents. Make sure the instrument is fully dry before reconnecting the power to avoid short circuiting or personal injury.

---

# General Inspection

Please check the instrument according to the following steps.

## **1. Inspect the shipping container.**

Keep the shipping container and packaging material until the contents of the shipment have been completely checked and the instrument has passed both electrical and mechanical tests. It is always good practice to save the shipping container and packaging for use when returning the power supply to Teledyne LeCroy for service or calibration.

The consigner or carrier will be responsible for damage to the instrument resulting from shipping. Teledyne LeCroy will not provide free maintenance or replacement in this instance.

## **2. Inspect the instrument.**

If the instrument is found to be damaged, defective or fails in electrical or mechanical tests, please contact the Teledyne LeCroy service department immediately.

## **3. Check the accessories.**

Please check that you have received the accessories on the packing list. If the accessories are incomplete or damaged, please contact Teledyne LeCroy immediately.

---

# Size and Adjustments

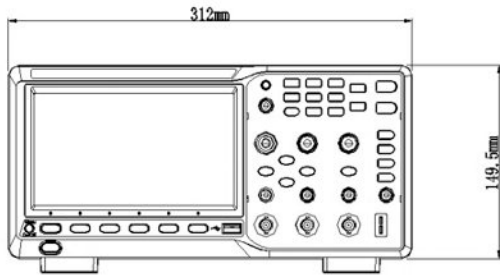

T3DSO1102 Front View

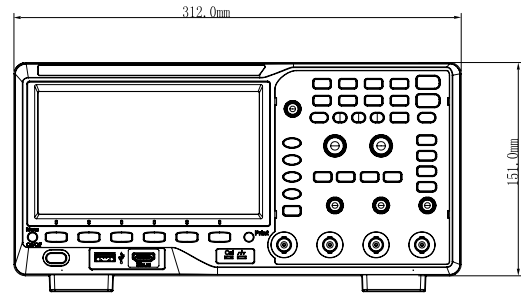

T3DSO1104 / T3DSO1202A / T3DSO1204 / T3DSO1302A Front View

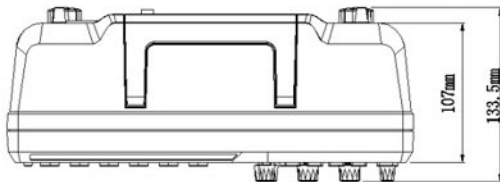

T3DSO1102 Top View

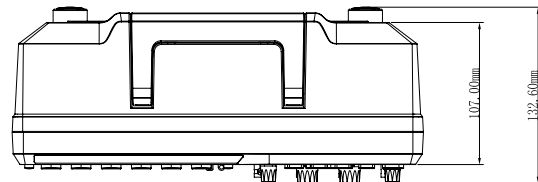

T3DSO1104 / T3DSO1202A / T3DSO1204 / T3DSO1302A Top View

## Adjusting the Supporting Legs

Adjust the supporting legs to adjust the angle / tilt of the oscilloscope for best ease of use. The oscilloscope is stable in flat or tilted mode. The oscilloscope is not stable if one supporting leg is extended and the other is not. Both supporting legs should either be extended or not.

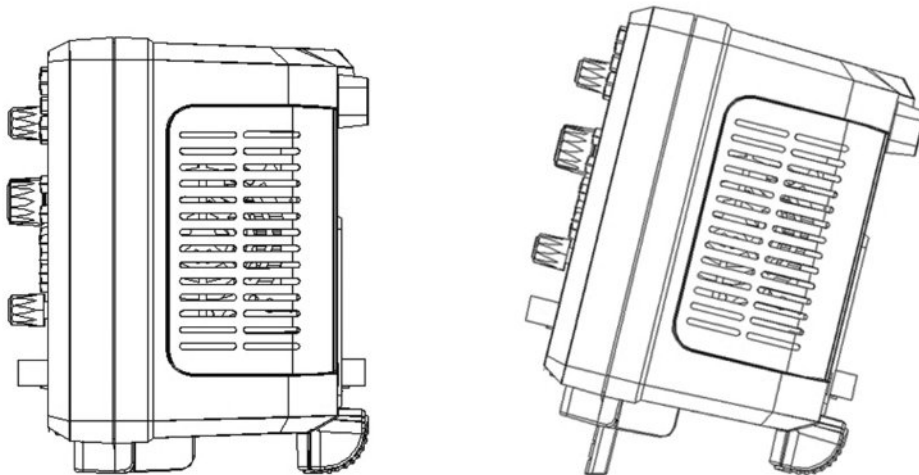

---

## Connecting to AC Power

The oscilloscope accepts 100-240 V, 50/60/440 Hz AC power. Use only the power cord provided to connect the instrument to the power source, as shown in the figure below.

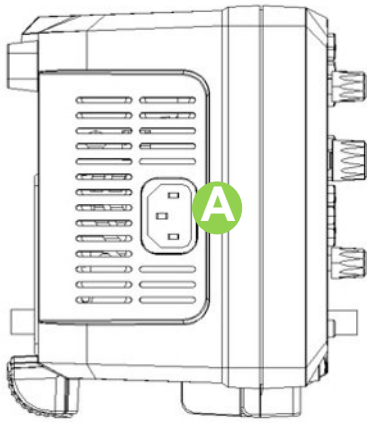

T3DSO1102

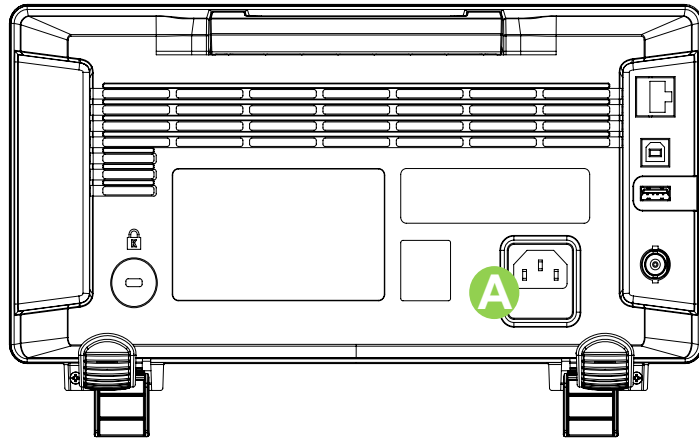

T3DSO1104 / T3DSO1204 / T3DSO1202A / T3DSO1302A

**A** Connect the power cord to socket A in the diagram above.

**Note:** If at any time the fuse requires replacement, please replace it only with a fuse of the same rating as the original. If there are questions, please contact Teledyne LeCroy service directly.

## Power-on Inspection

Turn on the power switch at the lower left corner on the front panel. During the start-up process, the instrument performs a series of self-tests and the user can hear the sound of relays switching. The User Interface displays immediately after the self-test is complete.



## Connecting and Compensating Probes

The Teledyne Test Tools oscilloscope is provided with one passive probe for for each channel (excluding Ext Trigger). Please refer to corresponding Probe User Manual for detailed probe technical information.

### Connecting Probes

1. Connect the BNC terminal of the probe to one of the channel BNC connectors on the front panel.
2. Connect the probe tip to the circuit point to test and the ground alligator clip of the probe to the ground terminal of the circuit.

## Functional Inspection

1. Press  to reset the oscilloscope to its factory default setup.
2. Connect the probe to CH1. Connect the ground alligator clip of the probe to the Ground Terminal on the front panel.
3. Connect the probe tip to the Compensation Signal Output Terminal on the front panel.
4. Press .
5. Observe the waveform on the screen. The display should be a square waveform as shown in the screen image below.
6. Test the other channels using the same method. The displayed square waveform should be a square wave as in the screen image below. If the displayed signal does not match the screen image below, then please perform a "Probe Compensation".

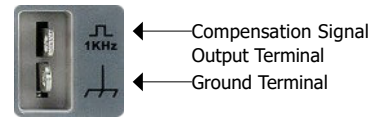

▲ T3DSO1102

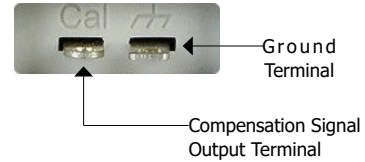

▲ T3DSO1104 / T3DSO1202A / T3DSO1204 / T3DSO1302A

Note: Please make certain that the insulated wire of the probe is in good condition to avoid electric shock when using the probes, and do not touch the metallic part of the probe when it is connected to a high voltage.

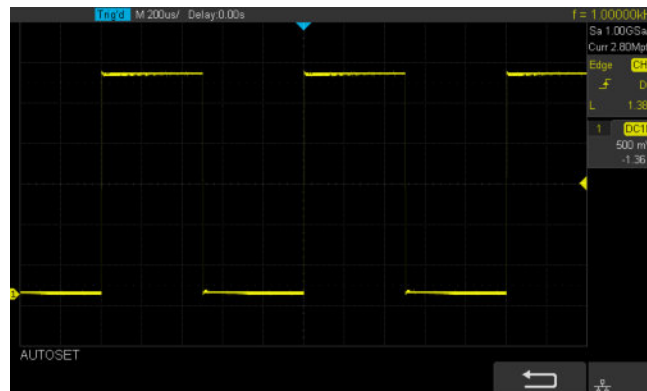

## Probe Compensation

The oscilloscope requires proper compensation adjustment to give accurate results. Non-compensated or inadequately compensated probes may give inaccurate measurements. Follow the steps below to adjust the probe compensation:

1. Check the displayed waveforms and compare them with the diagrams below.
2. Use a non-metallic screwdriver to adjust the low-frequency compensation adjustment hole on the probe until the waveform changes to be correctly compensated as in the centre figure below and the screen image above.

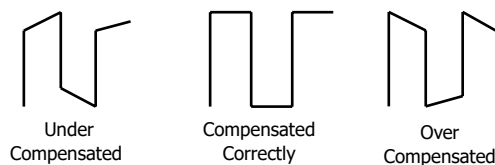

# Front Panel - T3DSO1102 Oscilloscope

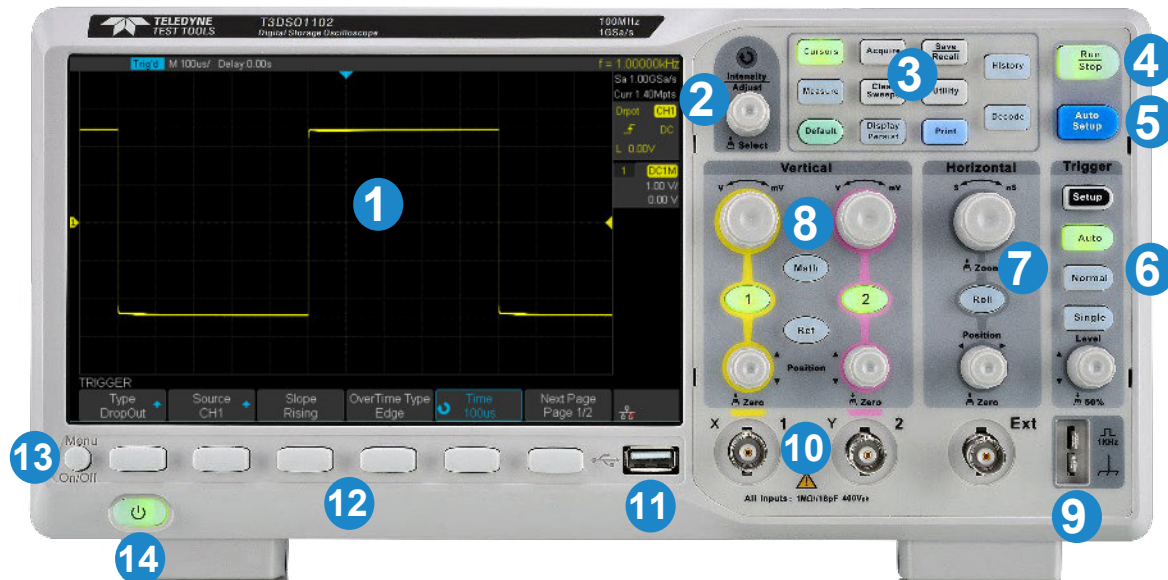

1. Waveform Display and User Interface
2. Universal Knob
3. Common Function Menus
4. Run/Stop Button
5. Auto Setup Button
6. Trigger Controls
7. Horizontal Controls

8. Channel Vertical Controls, Math and Ref
9. Probe Compensation
10. Analog Channel Inputs
11. USB Host Port
12. Function Menu Softkeys
13. Menu On/Off Button
14. Power On/Off Button

---

# Rear Panel - T3DSO1102 Oscilloscope

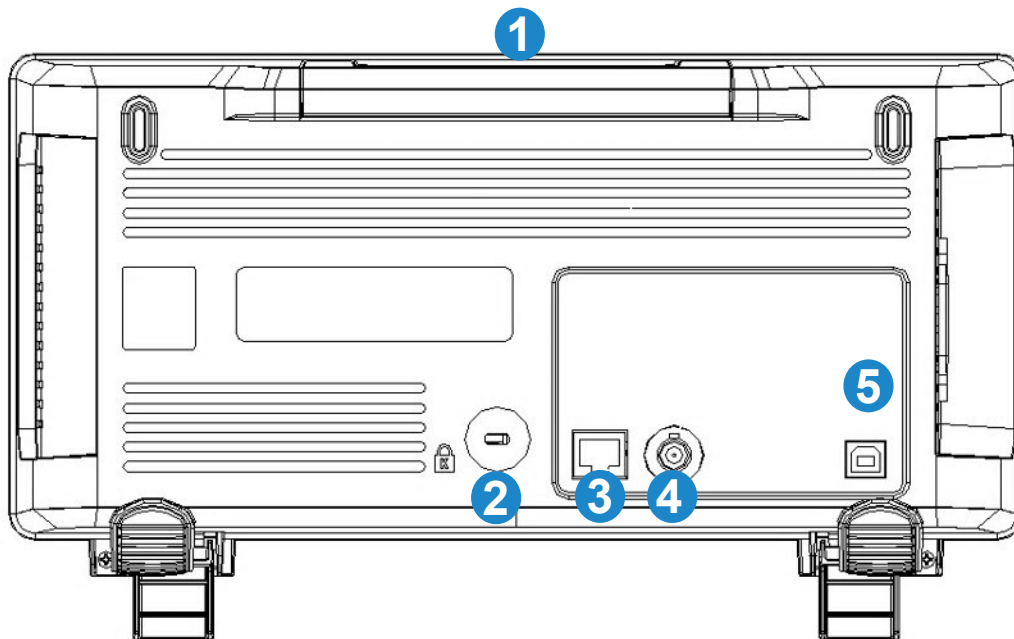

## 1. Handle

## 2. Safety Lock Hole

This is a Kensington Lock point to secure your oscilloscope. The Kensington Lock is not supplied with the oscilloscope.

## 3. LAN Interface

The instrument can be connected to the network via a LAN cable.

## 4. Pass/Fail or Trig Out Output

The connector can be configured to output a pulse when the oscilloscope triggers or output a pulse on a Pass/Fail condition.

## 5. USBTMC Device

The Teledyne Test Tools T3DSO1000 series oscilloscopes support SCPI remote control commands. User can control the oscilloscope through this interface

# Front Panel - T3DSO1104 / T3DSO1202A / T3DSO1204 / T3DSO1302A Oscilloscopes

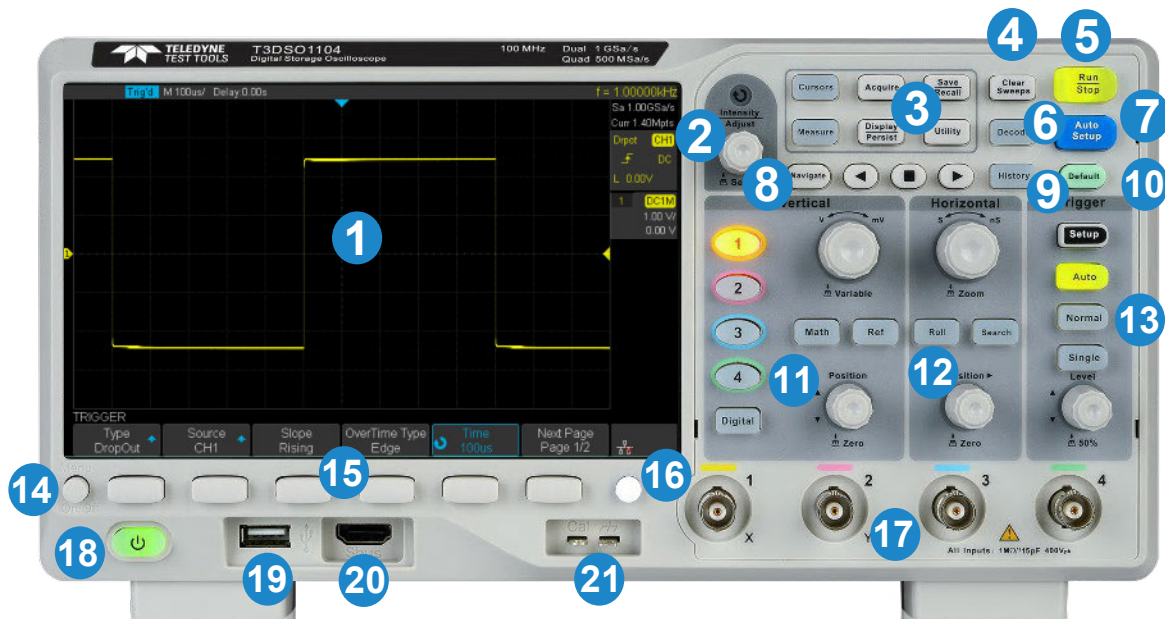

1. Waveform Display and User Interface
2. Universal Knob
3. Common Function Menus
4. Clear Sweeps
5. Run/Stop
6. Serial Bus Decode
7. Auto Setup
8. Navigate
9. History
10. Default Setup
11. Channel Vertical Control, Math, Reference and Digital
12. Horizontal Controls
13. Triggering Controls
14. Menu On/Off
15. Menu Softkeys
16. One Button Shortcut to Print/Save
17. Analog Channel Inputs
18. Power On/Off
19. USB Host Port
20. SBUS Digital Inputs
21. Probe Compensation

**WARNING:** Item 20 is not an HDMI interface. It is for the Teledyne Test Tools digital channels ONLY. Do not connect other devices or you may damage your oscilloscope.

**Note:** T3DSO1104 and T3DSO1204 do not have an EXT external trigger input.

**Note:** T3DSO1202A and T3DSO1302A input channels (item 17 above) comprises of two analog channels and an EXT external trigger input.

---

# Rear Panel - T3DSO1104 / T3DSO1202A / T3DSO1204 / T3DSO1302A Oscilloscopes

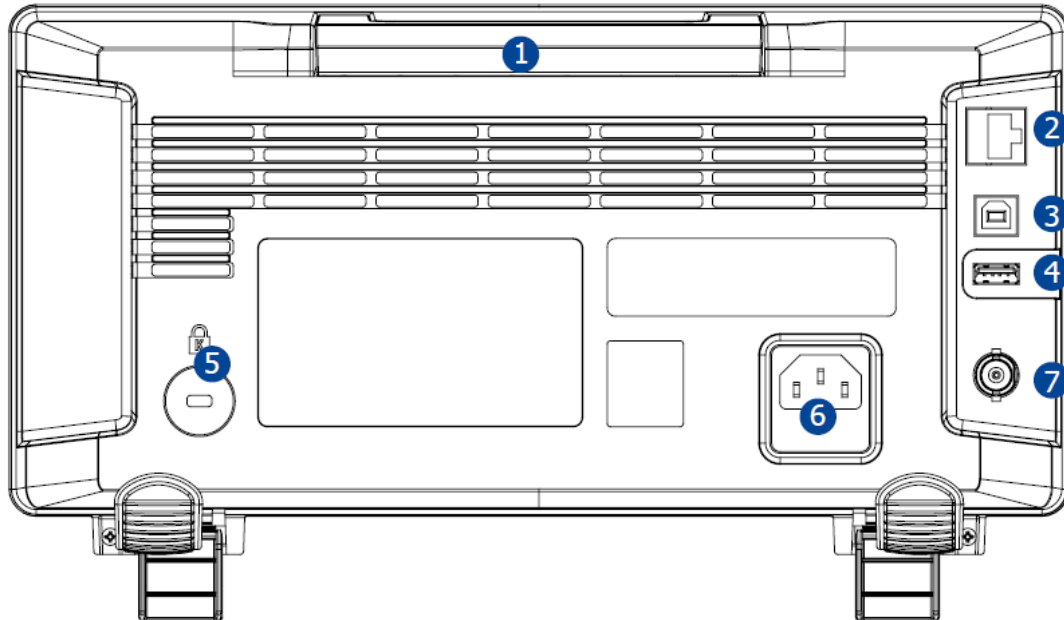

## 1. Handle

## 2. LAN Interface

The instrument can be connected to the network via a LAN cable.

## 3. USBTMC Device

The Teledyne Test Tools T3DSO1000 series oscilloscopes support SCPI remote control commands. User can control the oscilloscope through this interface

## 4. USB Host

## 5. Safety Lock Hole

This is a Kensington Lock point to secure your oscilloscope. The Kensington Lock is not supplied with the oscilloscope.

## 6. AC Power Socket

The power requirements of this oscilloscope are 100-240 V, 50/60/400 Hz. Use the power cord provided with the instrument to connect it to AC power.

## 7. Pass/Fail or Trig Out Output

The connector can be configured to output a pulse when the oscilloscope triggers or output a pulse on a Pass/Fail condition.

# Front Panel Operation

## Horizontal Control



Quickly enter into Roll mode. Roll mode gives screen updates similar to that of a strip chart recorder, and is primarily used for low frequency signals. The timebase range for Roll mode is from 50 ms/div to 100 s/div.

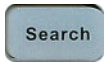

Enable or disable the search function. This function can search for the events that users specify in the acquired data, the results are displayed with white triangle symbol.



T3DSO1104 /  
T3DSO1202A /  
T3DSO1204 /  
T3DSO1302A



T3DSO1102



**Horizontal Position:** Adjusts the horizontal time location on the display. Zero time is the trigger point. The waveform will move left or right when the knob is turned. The Delay value will increase or decrease as the waveform moves. Press the knob to reset the trigger delay to zero.



**Horizontal Time Base:** The timebase is adjusted by turning the knob clockwise or anti-clockwise to increase or decrease the time window being captured on the oscilloscope. The waveform will be expanded or compressed when the timebase is adjusted. Press the knob to enter into Zoom mode.

## Trigger Adjustment



Press the Setup button to open trigger menu. The oscilloscope provides various trigger types: Edge, Slope, Pulse, Video, Window, Interval, DropOut, Runt, Pattern and Serial Bus (IIC / SPI / UART / RS232 / CAN / LIN)

Following is an introduction to Video, Interval, Runt, Pattern and Serial Bus trigger.

### HDTV Video Trigger

The T3DSO1000 supports analog video signal (NTSC / PAL) trigger and HDTV signal trigger. In video trigger, you can select custom to set any line and field

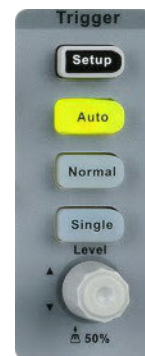

T3DSO1104 /  
T3DSO1202A /  
T3DSO1204 /  
T3DSO1302A



T3DSO1102

## Interval Trigger

The time interval from the rising edge (or falling edge) of input signal passes through the trigger level to the next rising edge(or falling edge) passes through the trigger level and the currently set time satisfy the Limit Range ( $< =$ ,  $> =$ , [ --.--], --] [--] selected.

In the figure below, the time interval between two continuous rising edge and the currently set time satisfy the limit range ([ --.--])

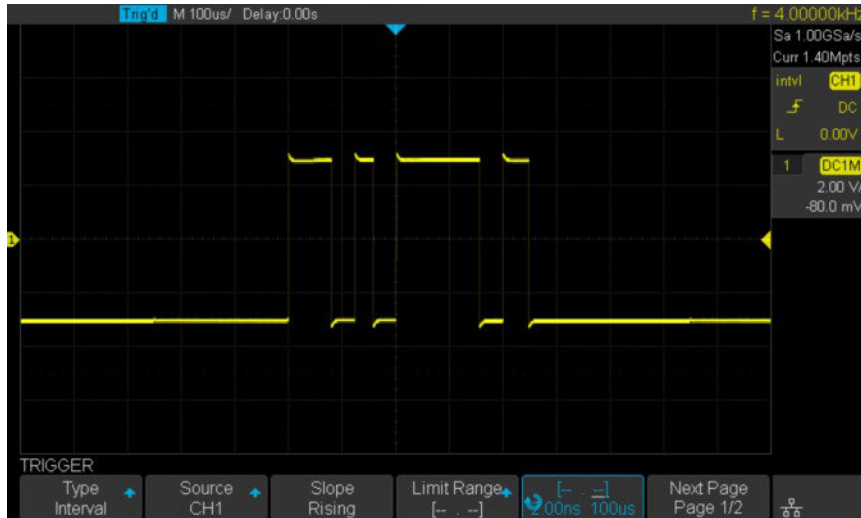

## Runt Trigger

Runt trigger includes positive runt trigger and negative runt trigger. This mode is used to trigger pulses that pass through one trigger level but fails to pass through the other trigger level as shown in the figure below.

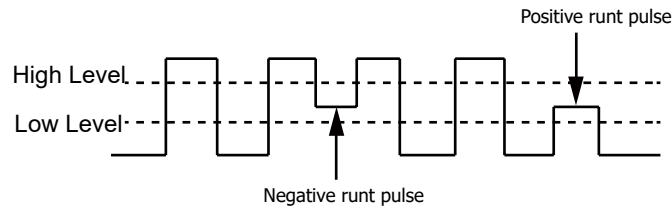

In the figure below, the trigger signal is a positive runt pulse.

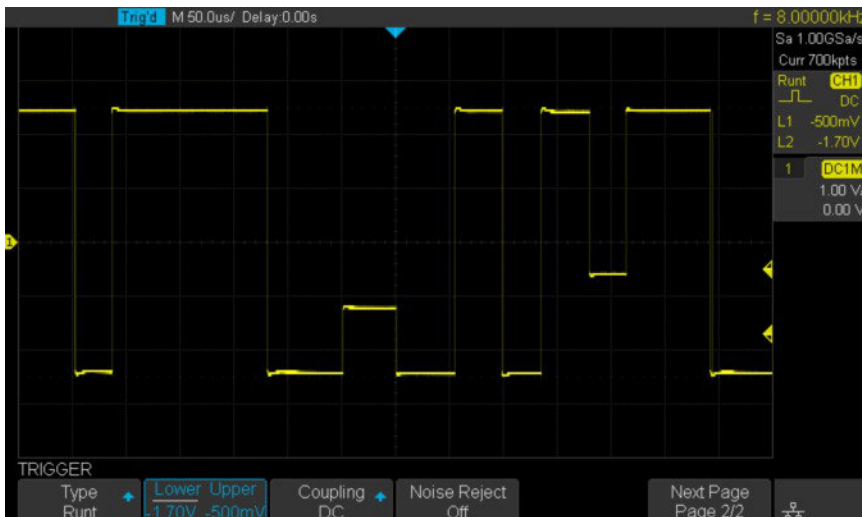

---

## Pattern Trigger

Identify a trigger condition by looking for a specified pattern. This pattern is a logical combination (AND / OR / NAND / NOR) of the channels. Each channel can be set a value among High, Low or Invalid.

In the figure below, the selected logic is "NAND", channel 1 is set to "Low", channel 2 is set to "High".



## I2C Trigger

Set the serial 1 or 2 to IIC type in trigger menu. Use universal knob to set to trigger on a start/stop condition, restart, no ack, EEPROM, or on the read / write frame with specific device address and data value. During IIC trigger settings, it is essential to set source channel previously in decode menu.

In the figure below, the trigger condition is set to "Start", channel 1 is set as Clock signal, channel 2 is set as Data signal.

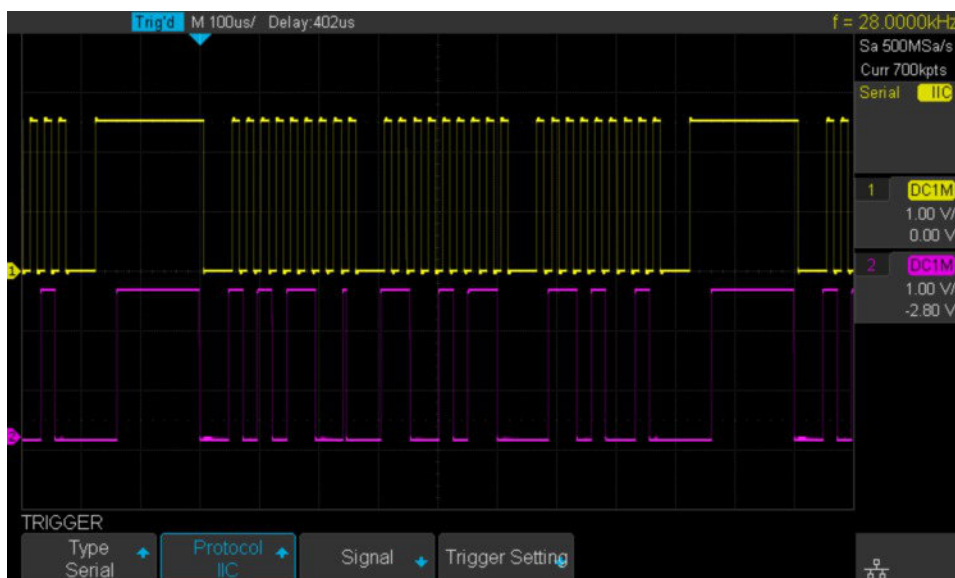

## SPI Trigger

After setting the serial trigger to SPI type in trigger menu, you can select to trigger on MISO data or MOSI data. The data length are variable to set from 4 to 96.

## UART/RS232 Trigger

After setting the serial trigger to UART/RS232 type in trigger menu, you can select to trigger on start , stop, checksum error or data. The data width are variable to set from 5 to 8bits.

## CAN Trigger

After setting the serial trigger to CAN type in trigger menu, you can select to trigger on start, remote, ID, ID+DATA or Error of CAN-H or CAN-L signal.

## LIN Trigger

After setting the serial trigger to LIN type in trigger menu, you can select to trigger on Start, ID, ID+DATA or Data Error.

 Press the button to set to Auto trigger mode.

 Press the button to set to Normal trigger mode.

 Press the button to set to Single trigger mode.



Use the Trigger Level knob to set the trigger level. Turn the knob clockwise or anticlockwise to change the level up or down. The trigger level value is displayed at the upper right of the screen and will increase or decrease accordingly. Press the knob to quickly reset the trigger level to the 50% level of the trigger channel waveform.

## Vertical Control

The two / four channels are marked by different colors which are also used to mark the waveforms on the screen and the channel input connectors. Press the channel button to open the corresponding channel and press again to turn it off.



**Vertical Position** Sets the vertical offset / position of the current waveform. Turn clockwise or anticlockwise to adjust the offset / waveform position.

During the adjustment, the waveform will move up and down and the offset message at the lower part of the screen will change. Press the knob to quickly reset the offset to zero.



**Vertical Scale:** Sets the vertical scale of the current waveform. Turn clockwise to decrease the scale and anticlockwise to increase it. During the adjustment, the 'amplitude' of the waveform will enlarge or reduce and the scale message at the right side of the screen will also change. Press the knob to quickly switch the vertical scale adjustment modes between "Coarse" and "Fine".



T3DSO1104 / T3DSO1202A /  
T3DSO1204 / T3DSO1302A

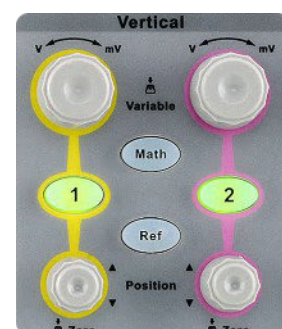

T3DSO1102

Math

Press the Math button to open math operation menu under which the operation of adding, subtracting, multiplying, dividing, FFT, integral, differential and square root are found.

Ref

Press the Ref button to enable the reference waveform function, enabling the user to compare the current waveform with the reference waveform.

Digital

Press the Digital button to open the digital channel function menu (Optional function). The T3DSO1104 / T3DSO1202A / T3DSO1204 and T3DSO1302A supports 16 digital channels with the appropriate options.

## Run Control

Auto Setup

Press the Auto Setup button to enable the waveform auto setup function. The oscilloscope will automatically adjust the horizontal time base, vertical scale and trigger mode according to the input signal to provide a triggered stable display if possible. If the waveform is a single event waveform, or very infrequent waveform (such as a low repetitive rate pulse) then the Auto Setup function may not work. The oscilloscope should be set up manually in these cases.

Run Stop

Press the Run / Stop button to set the state of the instrument to "RUN" or "STOP". In the "RUN" state, the button glows yellow; In "STOP" state, the button glows red.

## Universal Knob

Display Persist

### Adjust Waveform Intensity / Graticule / Transparency

Press the Intensity knob, and use the knob to adjust the waveform intensity (from 0% ~ 100%). The graticule (from 0% ~ 100%) or transparency (from 20% ~ 80%) adjust in the same way as waveform intensity.



### Universal Knob

In menu operation, when the light above the knob is lit, you could turn the knob to select between sub-menus under the current menu, and press the knob to select the current sub-menu. In addition, it can also be used to modify parameters and input filenames.

## Function Menus

Cursors

Press the Cursors button to open the cursor function. It provides manual and tracking cursor mode.

Display Persist

Press the Display / Persist button to enter the display menu and quickly enabled the persistence function. Users can set the grid, intensity, graticule and transparency.



T3DSO1102

---

## Function Menus continued



Press the Utility button to enter the utility menu. System functions and parameters, such as IO set, sound, language, can be set from this menu. In addition, some advanced functions (such as Pass/Fail, Do Self Cal, install option and Update) are also supported.



T3DSO1104 / T3DSO1202A / T3DSO1204 / T3DSO1302A



Press the History button to enter the history mode. The T3DSO1000 can record up to 80000 waveforms in history mode, depending on acquisition memory depth used.

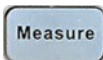

Press the Measure button to enter the measurement setting menu. The Measure menu allows the setting of measurement type, statistics function, all measurements and gated measurements. Four measurement parameters can be set. In statistics function, the Current value, Mean, Min, Max, Std-Dev and Count are shown on the screen. In all measure, all the parameters of the selected channel are shown.

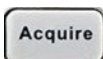

Press the Acquire button to enter the acquisition menu. You can set the acquisition mode to Normal / Peak-Detect / Average / Eres, interpolation mode (Sinx/X or linear), and memory depth. You can access and enable the XY function and sequence function.

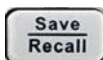

Press the Save / Recall button to enter the file save and recall function menu. The storable file types includes Setups, Waveforms, Picture and CSV.



Press the button to reset the oscilloscope to its default setup. A user can customize the default setup in the file save and recall function menu.

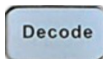

Press the Decode button to open the decode menu. Decode capability is a optional function. The T3DSO1000 supports two serial buses simultaneously including 1 and 2 for analog signal decoding. The protocols includes I2C, SPI, UART/RS232, CAN and LIN.

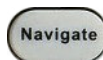

Press the Navigate button to turn off or turn on the navigate function. The T3DSO1104 / T3DSO1202A / T3DSO1204 / T3DSO1302A support three navigate types: time, search event, history frame.

# Display Overview

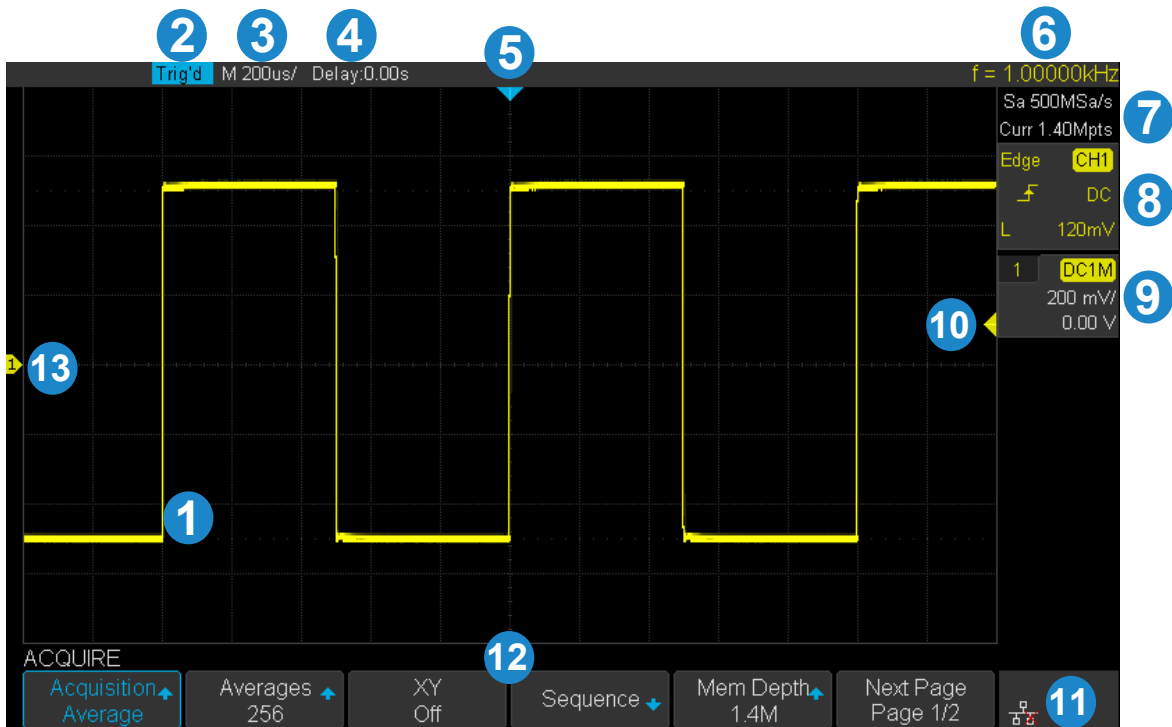

## 1. Waveform Display Area

Different channels are marked by different colors. The color of the waveform is the same as the color of the channel button and channel BNC connector.

## 2. Trigger state

Indication of the current trigger state. The possible trigger states are Arm, Ready, Trig'd, Stop, Auto.

## 3. Horizontal Time Base

The setting of the horizontal time per division. There are 14 divisions across the screen. Total time in the acquisition above is 200us per division or  $14 \times 200\text{us} = 2.8\text{ms}$  across the screen. The time per division can be varied from 1ns ~ 100s.



## 4. Delay

Use horizontal **POSITION** knob to modify the zero time position on the display and thereby adjust the screen delay. Turn the knob clockwise or counterclockwise to adjust the waveform delay position. This will cause the Delay parameter value to decrease or increase. Press the knob to automatically reset the parameter to zero delay as well as return the waveform to the horizontal centre of the screen.



## 5. Trigger position

The blue triangle is the zero time indicator, see 4 above. Zero time is the trigger position, therefore the blue triangle also displays the trigger position on the screen.

## 6. Frequency Counter

Shows the frequency of the displayed waveform.

---

## 7. Sample Rate/Memory Depth

Display the current sample rate and memory depth of the oscilloscope. Use horizontal SCALE knob to modify the parameter.

## 8. Trigger Setting

Displays the trigger settings: Trigger Type, Trigger Channel, Trigger Coupling, Trigger Offset. The color of the settings reflects the channel that the oscilloscope will trigger on, in this example Ch1.

Coupling Mode options are DC / AC / LF Reject / HF Reject.

The trigger level value of the current waveform is shown. Press the knob to reset the parameter to 50% of the waveform.

## 9. Channel Setting

Display the channel settings including coupling mode. Options are: DC / AC / GND.

Displays the voltage Scale in Y axis volts per division.

BW Limit. If the "BW Limit" is "On", then a small capital "B" is displayed.

Channel Impedance is displayed (1 M $\Omega$ ).

## 10. Trigger Level Position

Displays the voltage position of the trigger channel trigger level. Press the knob to reset the level to vertical center of the waveform.

## 11. Connection Status



Indicates the USB Host is connected.



Indicates that the WLAN port is disconnected



Indicates that the WLAN port is connected.



Indicates the LAN port is disconnected



Indicates the LAN port is connected.

## 12. Menu

The softkey menus of the currently selected function. Press any menu softkey to select the corresponding action.

## 13. Zero Voltage Level Indicator

Indicator of where the zero voltage level is for each channel. One color coded marker for each channel.

---

# Troubleshooting

Commonplace problems and potential solutions are listed below. If the problem proves to be unsolvable, please contact Teledyne LeCroy Service Department as soon as possible for help and advice.

## **The screen remains blank after the power is turned on:**

1. Check if the power is correctly connected.
2. Check if the power switch is off on the oscilloscope and wall socket connection.
3. Check whether the fuse has blown. If the fuse needs to be changed, please change the fuse for a fuse of the same specification. If this fuse blows immediately then please contact Teledyne LeCroy Service Department as soon as possible and return the instrument to the factory for repair.

## **After the signal is sampled, there is no corresponding waveform displayed:**

1. Check if the probe is correctly connected to the DUT signal and to the oscilloscope BNC.
2. The probe can be checked by connecting it to the oscilloscope square wave compensation signal. This should produce a square wave on the scope display.
3. Check that the DUT is powered on and that it is generating waveforms.
4. Set the oscilloscope trigger to Auto. See if a waveform is displayed.

## **The voltage amplitude measured is higher or lower than the actual value (this error usually occurs when using a probe):**

Check if the attenuation coefficient of the channel matches the attenuation ratio of the probe.

## **There is an unstable waveform displayed:**

1. Check the trigger source: check whether the "Source" in the "TRIG" menu is the actual operating channel.
2. Adjust the trigger level. An unstable waveform can be displayed if the trigger waveform is noisy. The waveform can often be stabilised by adjusting the trigger level.
3. Check the trigger type: "Edge" trigger suits general waveforms but can produce unstable waveforms on burst type signals such as video, modulated waveforms and serial bus waveforms.
4. Check and adjust the trigger holdoff. Trigger Holdoff does not allow the trigger to re-arm for a specified length of time. This is very useful for stabilising burst type waveforms.

## **There is no waveform display after pressing Run / Stop:**

Check whether the trigger Mode is "Normal" or "Single", and if the trigger level exceeds the waveform range. The oscilloscope will not trigger if the trigger level exceeds the size of the waveform and the oscilloscope is in Normal or Single mode.



Set the trigger to Auto Trigger and see if a waveform is displayed. The trigger level is usually out of range if the waveform is only displayed during Auto and not during Normal or Single. Alternatively the trigger type is incorrectly set up.

---

**An aliased waveform is displayed:**

The horizontal time base may be too low. Increase the horizontal time base to improve the horizontal resolution and remove the aliased waveform.

**USB storage isn't recognized:**

1. Not all USB storage is supported. Make sure the USB drive being used is flash and also check the size of the flash drive. Large USB flash storage is not supported.
2. USB 3.0 flash drives are not supported.



## ABOUT TELEDYNE TEST TOOLS

### Company Profile

Teledyne LeCroy is a leading provider of oscilloscopes, protocol analyzers and related test and measurement solutions that enable companies across a wide range of industries to design and test electronic devices of all types. Since our founding in 1964, we have focused on creating products that improve productivity by helping engineers resolve design issues faster and more effectively. Oscilloscopes are tools used by designers and engineers to measure and analyze complex electronic signals in order to develop high-performance systems and to validate electronic designs in order to improve time to market.

The Teledyne Test Tools brand expands on the Teledyne LeCroy product portfolio by adding a comprehensive range of test equipment solutions for its customers. The new range of product solutions deliver engineers with a broad range of quality test solutions that enables speed to market product validation and design. More and more designers, engineers and lecturers are relying on Teledyne Test Tools to meet their testing, education and electronics validation needs with confidence and within budget.

### Location and Facilities

Headquartered in Chestnut Ridge, New York, Teledyne Test Tools and Teledyne LeCroy have sales, service and development subsidiaries in the US and throughout Europe and Asia. Teledyne Test Tools and Teledyne LeCroy products are employed across a wide variety of industries, including semiconductor, computer, consumer electronics, education, military/aerospace, automotive/industrial, and telecommunications.

#### Teledyne LeCroy (US Headquarters)

700 Chestnut Ridge Road  
Chestnut Ridge, NY. USA  
10977-6499  
**Phone:** 800-553-2769 or 845-425-2000  
**Fax Sales:** 845-578-5985  
**Email Sales:** [contact.corp@teledynelecroy.com](mailto:contact.corp@teledynelecroy.com)  
**Email Support:** [support@teledynelecroy.com](mailto:support@teledynelecroy.com)  
(Oscilloscopes, Waveform Generators, Signal Integrity)  
**Web Site:** <http://teledynelecroy.com/>  
**Phone Support:** 1-800-553-2769

#### Teledyne LeCroy (European Headquarters)

**Teledyne LeCroy GmbH**  
Im Breitspiel 11c  
D-69126 Heidelberg, Germany  
**Phone:** + 49 6221 82700  
**Fax:** +49 6221 834655  
**Fax Sales:** +49 6221 834655 **Fax**  
**Service:** +41 22 719 22 99  
**Email Sales:** [contact.gmbh@teledynelecroy.com](mailto:contact.gmbh@teledynelecroy.com)  
**Email Service:** [service.gmbh@teledynelecroy.com](mailto:service.gmbh@teledynelecroy.com)  
**Email Support:** [applications.de@teledynelecroy.com](mailto:applications.de@teledynelecroy.com)  
**Web Site:** <http://teledynelecroy.com>  
**Phone Service:** +49 6221 8270 85  
**Phone Support:** +49 6221 8270 28

