

Dual-channel Programmable DC Power Supply

IT-M3100D Series User Manual



Notices

© Itech Electronic, Co., Ltd. 2025

No part of this manual may be reproduced in any form or by any means (including electronic storage and retrieval or translation into a foreign language) without prior permission and written consent from Itech Electronic, Co., Ltd. as governed by international copyright laws.

Manual Part Number



402225

Trademarks

Pentium is U.S. registered trademarks of Intel Corporation.

Microsoft, Visual Studio, Windows and MS Windows are registered trademarks of Microsoft Corporation in the United States and/or other countries and regions.

Warranty

The materials contained in this document are provided “as is”, and is subject to change, without prior notice, in future editions. Further, to the maximum extent permitted by applicable laws, ITECH disclaims all warranties, either express or implied, with regard to this manual and any information contained herein, including but not limited to the implied warranties of merchantability and fitness for a particular purpose. ITECH shall not be held liable for errors or for incidental or indirect damages in connection with the furnishing, use or application of this document or of any information contained herein. Should ITECH and the user enter into a separate written agreement with warranty terms covering the materials in this document that conflict with these terms, the warranty terms in the separate agreement shall prevail.

Technology Licenses

The hardware and/or software described herein are furnished under a license and may be used or copied only in accordance with the terms of such license.

Restricted Rights Legend

Restricted permissions of the U.S. government. Permissions for software and technical data which are authorized to the U.S. Government only include those for custom provision to end users. ITECH follows FAR 12.211 (technical data), 12.212 (computer software). DFARS 252.227-7015 (technical data—commercial products) for national defense and DFARS 227.7202-3 (permissions for commercial computer software or computer software documents) while providing the customized business licenses of software and technical data.

Safety Notices

CAUTION

A CAUTION sign denotes a hazard. It calls attention to an operating procedure or practice that, if not correctly performed or adhered to, could result in damage to the product or loss of important data. Do not proceed beyond a CAUTION sign until the indicated conditions are fully understood and met.

WARNING

A WARNING sign denotes a hazard. It calls attention to an operating procedure or practice that, if not correctly performed or adhered to, could result in personal injury or death. Do not proceed beyond a WARNING sign until the indicated conditions are fully understood and met.



Note

A NOTE sign denotes important hint. It calls attention to tips or supplementary information that is essential for users to refer to.

Quality Certification and Assurance

We certify that series instrument meets all the published specifications at time of shipment from the factory.

Warranty

ITECH warrants that the product will be free from defects in material and workmanship under normal use for a period of one (1) year from the date of delivery (except those described in the Limitation of Warranty below).



Note

Visit <https://www.itechate.com/en/support/register.html> to complete product registration by filling out the necessary information to extend the warranty to two (2) years.

For warranty service or repair, the product must be returned to a service center designated by ITECH.















- The product returned to ITECH for warranty service must be shipped PRE-PAID. And ITECH will pay for return of the product to customer.
- If the product is returned to ITECH for warranty service from overseas, all the freights, duties and other taxes shall be on the account of customer.

Limitation of Warranty

This Warranty will be rendered invalid in case of the following:

- Damage caused by circuit installed by customer or using customer own products or accessories;
- Modified or repaired by customer without authorization;
- Damage caused by circuit installed by customer or not operating our products under designated environment;
- The product model or serial number is altered, deleted, removed or made illegible by customer;
- Damaged as a result of accidents, including but not limited to lightning, moisture, fire, improper use or negligence.

Safety Symbols

	Direct current		ON (power)
	Alternating current		OFF (power)
	Both direct and alternating current		Power-on state
	Chassis (earth ground) symbol.		Power-off state
	Earth (ground) terminal		Reference terminal
	Caution		Positive terminal
	Warning (refer to this manual for specific Warning or Caution information)		Negative terminal
	A chassis terminal	-	-

Safety Precautions

The following safety precautions must be observed during all phases of operation of this instrument. Failure to comply with these precautions or specific warnings elsewhere in this manual will constitute a default under safety standards of design, manufacture and intended use of the instrument. ITECH assumes no liability for the customer's failure to comply with these precautions.

WARNING

- **Do not use the instrument if it is damaged. Before operation, check the casing to see whether it cracks. Do not operate the instrument in the presence of inflammable gasses, vapors or dusts.**
 - **The instrument is provided with a power cord during delivery and should be connected to a socket with a protective earth terminal, a junction box or a three-phase distribution box. Before operation, be sure that the instrument is well grounded.**
 - **Please always use the provided cable to connect the instrument.**
 - **Check all marks on the instrument before connecting the instrument to power supply.**
 - **Ensure the voltage fluctuation of mains supply is less than 10% of the working voltage range in order to reduce risks of fire and electric shock.**
 - **Do not install alternative parts on the instrument or perform any unauthorized modification.**
 - **Do not use the instrument if the detachable cover is removed or loosen.**
 - **To prevent the possibility of accidental injuries, be sure to use the power adapter supplied by the manufacturer only.**
 - **We do not accept responsibility for any direct or indirect financial damage or loss of profit that might occur when using the instrument.**
 - **This instrument is used for industrial purposes, do not apply this product to IT power supply system.**
 - **Never use the instrument with a life-support system or any other equipment subject to safety requirements.**
-

WARNING

- **SHOCK HAZARD Ground the Instrument.** This product is provided with a protective earth terminal. To minimize shock hazard, the instrument must be connected to the AC mains through a grounded power cable, with the ground wire firmly connected to an electrical ground (safety ground) at the power outlet or distribution box. Any interruption of the protective (grounding) conductor or disconnection of the protective earth terminal will cause a potential shock hazard that could result in injury or death.
 - **Before applying power, verify that all safety precautions are taken.** All connections must be made with the instrument turned off, and must be performed by qualified personnel who are aware of the hazards involved. Improper actions can cause fatal injury as well as equipment damage.
 - **SHOCK HAZARD, LETHAL VOLTAGES** This product can output the dangerous voltage that can cause personal injury, and the operator must always be protected from electric shock. Ensure that the output electrodes are either insulated or covered using the safety covers provided, so that no accidental contact with lethal voltages can occur.
 - **Never touch cables or connections immediately after turning off the instrument.** Verify that there is no dangerous voltage on the electrodes or sense terminals before touching them.
 - **After using the device, turn off the power switch of the device before unplugging the power cord or disassembling the terminals.** Do not touch the cable or the terminal immediately. Depending on the model, the dangerous voltage at the plug or terminal is maintained for 10 seconds after the device is switched off. Make sure that there is no dangerous voltage before touching them.
-

CAUTION

- **Failure to use the instrument as directed by the manufacturer may render its protective features void.**
 - **Always clean the casing with a dry cloth. Do not clean the internals.**
 - **Make sure the vent hole is always unblocked.**
-

Environmental Conditions





The instrument is designed for indoor use and an area with low condensation. The table below shows the general environmental requirements for the instrument.

Environmental Conditions	Requirements
Operating temperature	0°C ~ 40°C
Operating humidity	20% ~ 80%(non-condensation)
Storage temperature	-10°C ~ 70 °C
Altitude	Operating up to 2,000 meters
Installation category	II
Pollution degree	Pollution degree 2



Note

In order to ensure the accuracy of measurement, it is recommended to operate the instrument half an hour after start-up.

Regulation Tag

	The CE tag shows that the product complies with the provisions of all relevant European laws (if the year is shown, it indicates that the year when the design is approved).
	The UKCA tag shows that the product complies with the provisions of all relevant United Kingdom laws (if the year is shown, it indicates that the year when the design is approved).
	This instrument complies with the WEEE directive (2002/96/EC) tag requirements. This attached product tag shows that the electrical/electronic product cannot be discarded in household waste.
	This symbol indicates that no danger will happen or toxic substances will not leak or cause damage in normal use within the specified period. The service life of the product is 10 years. The product can be used safely within the environmental protection period; otherwise, the product should be put into the recycling system.

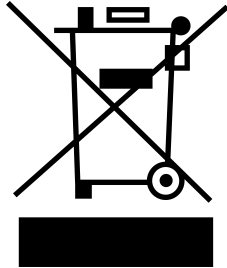
Waste Electrical and Electronic Equipment (WEEE) Directive



Waste electrical and electronic equipment (WEEE) directive, 2002/96/EC

The product complies with tag requirements of the WEEE directive (2002/96/EC). This tag indicates that the electronic equipment cannot be disposed of as ordinary household waste. Product Category

According to the equipment classification in Annex I of the WEEE directive, this instrument belongs to the "Monitoring" product.

If you want to return the unnecessary instrument, please contact the nearest sales office of ITECH.



Compliance Information

Complies with the essential requirements of the following applicable European Directives, and carries the CE marking accordingly:

- Electromagnetic Compatibility (EMC) Directive 2014/30/EU
- Low-Voltage Directive (Safety) 2014/35/EU

Conforms with the following product standards:

EMC Standard

IEC 61326-1 / EN 61326-1 ¹²³

Reference Standards

CISPR 11, Class A

IEC 61000-3-2

IEC 61000-3-3

IEC 61000-4-2

IEC 61000-4-3

IEC 61000-4-4

IEC 61000-4-5

IEC 61000-4-6

IEC 61000-4-11

1. The product is intended for use in non-residential/non-domestic environments. Use of the product in residential/domestic environments may cause electromagnetic interference.
2. Connection of the instrument to a test object may produce radiations beyond the specified limit.
3. Use high-performance shielded interface cable to ensure conformity with the EMC standards listed above.

Safety Standard

IEC 61010-1:2010+A1:2016



Note

This section provides general and universal terms. For more detailed information on the *Declaration of Conformity*, please contact ITECH personnel.

Content

Quality Certification and Assurance	I
Warranty	I
Limitation of Warranty	I
Safety Symbols	II
Safety Precautions.....	II
Environmental Conditions.....	IV
Regulation Tag.....	V
Waste Electrical and Electronic Equipment (WEEE) Directive	VI
 Compliance Information	VII
1 Quick Reference.....	1
1.1 Brief Introduction.....	1
1.2 Front-Panel Overview	2
1.3 Keyboard Introduction.....	3
1.4 Home-Screen Overview.....	4
1.5 Prompt Information Reference.....	5
1.6 Rear-Panel Overview.....	7
1.7 Front Panel Menu Reference.....	8
1.7.1 Configuration Menu Reference	8
1.7.2 System Menu Reference	9
1.7.3 Protect Function Menu Reference.....	13
1.7.4 Advanced Function Menu Reference	14
1.8 Models and Options	14
2 Inspection and Installation.....	18
2.1 Verifying the Shipment.....	18
2.2 Instrument Size Introduction	19
2.3 Rack Mounting	19
2.4 Stacking Instruments	20
2.5 Connecting the Power Cord.....	20
2.6 Connecting the Device Under Test (DUT)	22
2.7 Connect the Communication Interface	25
2.7.1 USB Interface	27
2.7.2 LAN Interface.....	28
2.7.3 CAN Interface	34
2.7.4 GPIB Interface	36
2.7.5 RS-232 Interface	37
2.7.6 RS-485 Interface	39
3 Getting Started	41
3.1 Power-on the Instrument	41
3.2 Set the Output Voltage.....	43
3.3 Set the Output Current.....	43
3.4 Set the Output Power.....	43
3.5 Use the Front Panel Menu	44
3.6 Output On/Off Control	45
4 Functions and Features.....	46
4.1 Output Function	46
4.1.1 Set the Output Priority Mode	46
4.1.2 Set the Output-On/Output-Off Delay Time	47
4.1.3 Set the Sense Function State.....	47
4.1.4 Set the Bleeder State (Bleeder).....	48
4.1.5 Select Trigger Source(Trig Source).....	48
4.1.6 Output Lock Control.....	49
4.2 System-Related Operations.....	50

4.2.1	Set the Key Beeper.....	50
4.2.2	Set the Power-on State	50
4.2.3	Set the Communication Information	51
4.2.4	Set the TRIG± Interface Status (Ext IO).....	51
4.2.5	Restore the Factory Default Settings	52
4.2.6	View the System Information.....	54
4.2.7	Switch Local/Remote Mode.....	55
4.2.8	Key Lock Function	55
4.2.9	Save and Recall Operations.....	55
4.3	Multi-Machine Operation.....	56
4.3.1	Multi-Channel Function	57
4.3.2	Synchronized Function (Link).....	59
4.4	Channel Parallel Function (Parallel).....	62
4.5	Channel Series Function (Series).....	64
4.6	Protection Function	66
4.6.1	Set the Setting Value Limit Protection	66
4.6.2	Set Over-Voltage Protection	67
4.6.3	Set Over-Current Protection	68
4.6.4	Set Over-Power Protection.....	69
4.6.5	Over-Temperature Protection	70
4.6.6	Set foldback protection	71
4.7	List Function.....	72
4.7.1	Edit List Program	73
4.7.2	Copy List Program.....	75
4.7.3	View List Program.....	75
4.7.4	Run List Program.....	76
4.8	Single Channel External Analog Function (Option).....	76
4.9	Dual Channel External Analog Function (Option)	82
5	Specification	86
5.1	IT-M3131D	86
5.2	IT-M3132D	88
5.3	IT-M3141D	90
5.4	IT-M3142D	92
5.5	Supplemental Characteristics	95
6	Routine Maintenance	96
6.1	Instrument Self-Test.....	96
6.2	Cleaning and Maintenance	96
6.3	Contact of ITECH Engineers	97
6.4	Return for Repair.....	98
A	Appendix	100
A.1	Specifications of Red and Black Test Cables	100

1 Quick Reference

This chapter briefly introduces the front panel, rear panel, keyboard button functions and front panel display functions of this series instrument to ensure a quick understanding of the appearance, structure and key usage features of the instrument before operating the instrument. This chapter does not introduce each operating characteristic in detail. It is just a quick reference guide to help you quickly learn the operating characteristics of the instrument.

- ◆ [Brief Introduction](#)
- ◆ [Front-Panel Overview](#)
- ◆ [Keyboard Introduction](#)
- ◆ [Home-Screen Overview](#)
- ◆ [Prompt Information Reference](#)
- ◆ [Rear-Panel Overview](#)
- ◆ [Front Panel Menu Reference](#)
- ◆ [Models and Options](#)

1.1 Brief Introduction

The IT-M3100D series power supply is a compact, high power density, high performance programmable DC power supply, provides fully isolated dual-channel output. To increase its mounting efficiency, a thin and lightweight design with 1U height and 1/2 rack width is adopted. The outputs of voltage and current is limited by the maximum output power. The user can get higher voltage by decreasing the output current or get larger current by decreasing the output voltage. A wide range of voltage and current settings can be obtained by one instrument. what's more, to meet with further development, test and system requirement, multichannel operation (up to 16 channels) and synchronized operation features are employed to allow extended output.

Performance and functions:

- High visible vacuum fluorescent display (VFD)
- High resolution, high accuracy and high stability
- High speed measurement capability
- Intelligent fan control, saving energy and reducing noise
- List function
- Output-on/off delay function to customize test timing
- 2-channel parallel operation function of a single instrument
- Synchronized operation

- Multichannel operation
- Supporting various optional interfaces: GPIB/ USB/ RS-485/ RS-232/ CAN/ LAN/ External analog interface

1.2 Front-Panel Overview

All of the IT-M3100D series power supplies have the same front panels. The detailed descriptions are shown as below.





Name	Description
[Shift] key	Composite key, combined with other keys to realize functions marked above keys.
[Link] (Local) key	<ul style="list-style-type: none"> • Turn the synchronized operation feature on or off. When lit, indicates that the instrument is in the synchronous relationship. • In remote control, press [Shift]+[Link] keys to switch the instrument to local control mode.
Power On/Off switch	Turns instrument on or off.
Vacuum fluorescent display (VFD)	Displays all instrument functions. The information changes based on selected function.
CH1/CH2	Channel switch key
[On/Off] key	Turns the instrument output on or off. When lit, indicates that the output is enabled or on.
Function keys group	Refer to 1.3 Keyboard Introduction for the detailed description about the function keys.
Push-on knob	<ul style="list-style-type: none"> • Rotate the knob to adjust the voltage and current values or scroll pages to view menu items. Rotate the knob clockwise to increase the set value and anticlockwise to decrease the set value. • Pushing the knob acts like pressing [Enter] key to confirm an operation.
Left, and right arrow keys	Moves the cursor below the setting value or scrolls pages to view menu items.

1.3 Keyboard Introduction

The keyboard introduction of IT-M3100D series power supplies is shown as follows.



Keys	Description
CH1 CH2	Switch channels.
[On/Off]	Turns the instrument output on or off. When lit, indicates that the output is enabled or on.
[V-set]	Sets the output voltage value.
[I-set]	Sets the output current value.
[Display]	Display the measurement value
[ALL On/Off]	Simultaneously turns on/off the outputs of both channels.
[Esc]	Returns to the previous menu level.
[Enter]	Selects the menu item or confirm an operation.
 	Moves the cursor below the setting value or scrolls pages to view menu items.

Composite key **[Shift]**, combined with other keys to realize functions marked above keys. The detailed functions are listed as follows.

Keys	Description
[Shift]+[V-set] (Config)	Enter the Config menu.
[Shift]+[I-set] (Function)	Enter the Function menu.
[Shift]+[Display] (System)	Enter the System menu.
[Shift]+[Esc] (Protect)	Enter the Protect menu.
[Shift]+[Link] (Local)	Switch remote control mode to local control mode.
[Shift]+[On/Off] (Trigger)	Generate a local trigger signal.
[Shift]+[Left] (Save)	Saves the present settings. IT-M3100 power supplies support up to 10 saved setups.
[Shift]+[Right] (Recall)	Returns the instrument to the specified setup.
[Shift]+[Enter] (Lock)	Turn the keyboard lock on or off.

1.4 Home-Screen Overview

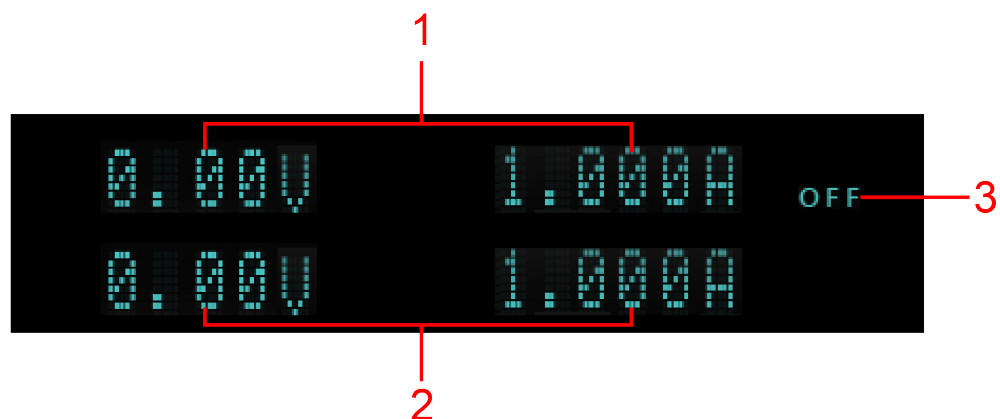

IT-M3100D series power supplies run a self-test automatically when it is turned on. If the self-test finishes with no errors, the screen below is displayed.



No.	Name	Description
1	Output values view area	Displays the present output voltage and current values.
2	Setting values view area	Shows the present setting voltage and current values. You can change these values by pressing the [V-set] and [I-set] keys on the front panel.
3	Output status	Displays the present output status. The power supply always has one of the following status visible: <ul style="list-style-type: none"> • OFF: The output is turned off. • CC: The output is turned on and the power supply is in constant current (CC) mode. • CV: The output is turned on and the power supply is in constant voltage (CV) mode. • CP: The output is turned on, the power supply is in constant power mode. • : the power supply is in the output-on delay time or output-off delay time.

1.5 Prompt Information Reference

The instrument provides detailed prompt information to help the user learn the function well.

Prompt Information	Description
	Indicates output delay time
	Indicates the key is locked.
	Indicates the instrument is in remote control.
Ri	Indicates the output is self-locked.
System Selftest	Indicates the instrument is running the system selftest.
Switch To Master Mode	Indicates the instrument is switching to the master mode.

Prompt Information	Description
Over Current Protect	Indicates the instrument is under over-current protection.
Over Power Protect	Indicates the instrument is under over-power protection.
Over Voltage Protect	Indicates the instrument is under over-voltage protection.
Under Current Protect	Indicates the instrument is under under-current protection.
Under Voltage Protect	Indicates the instrument is under under-voltage protection.
Sense Warning	Indicates the instrument is under sense abnormal warning. When a Sense output fault is detected, the instrument will disable the Sense function and switch to local output mode.
Over Temp Protect	Indicates the instrument is under over-temperature protection.
Watch Dog Protect	Indicates the instrument is under software watchdog protection.
Undefine Prot	Indicates the undefined protection happens.
The Key Is Locked!	Indicates the key is locked.
Remote Mode!	Indicates the instrument is in remote control mode.
RWT Mode!	Indicates the instrument is in remote control mode and pressing the LOCAL button does not switch the instrument to local control mode.
Save Successful	Indicates the save operation is successful.
Save Failed	Indicates the save operation fails.
File is empty!	Indicates the recalled file is empty.
Waiting for Trigger	Indicates the list program is waiting for trigger.
Input Cal Code To Start:	Indicates the user needs to input the calibration code

Prompt Information	Description
Cal Is Initing...	Indicates the calibration operation is initializing.
Calibration Finished!	Indicates the calibration operation is finished.

1.6 Rear-Panel Overview

The detailed descriptions of the IT-M3100D series power supplies are shown as below.

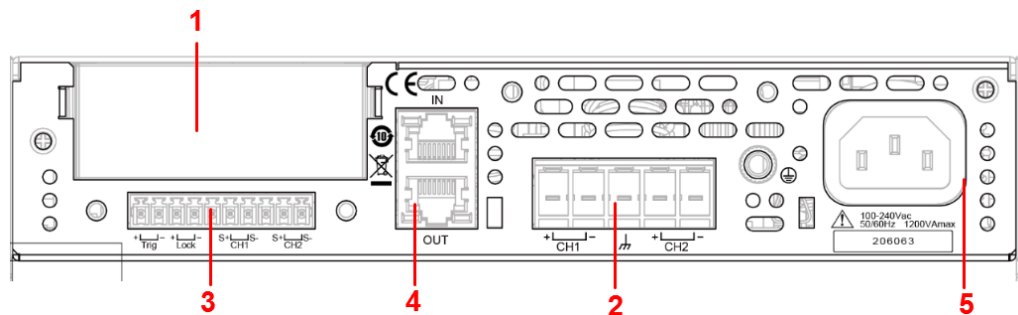

No.	Name	Description
1	Optional expansion slot	Optional interfaces: (Plastic plugs are inserted by default when the user does not purchase the interface.) <ul style="list-style-type: none"> IT-E1205: GPIB interface IT-E1206: USB and LAN interfaces IT-E1207: RS-232 and CAN interfaces IT-E1208: Single Channel Analog interface and RS-485 IT-E1208D: Dual Channel Analog interface and RS-485 IT-E1209: USB interface
2	DC output terminals	Used to connect DUT.
3	<ul style="list-style-type: none"> Remote sense terminals (Sense \pm) Output lock terminals (Lock\pm) 	The descriptions of each terminals are as follows. <ul style="list-style-type: none"> Remote sense terminals, used for maximizing measurement accuracy. Output lock terminals, short Lock+ and Lock- terminals to disable the output function of the power supply. Trigger signal terminals, when set to In, the terminals can receive high level pulse signal as a trigger source; when set to Out, if the

No.	Name	Description
	<ul style="list-style-type: none"> Trigger signal terminals (TRIG±) 	trigger happens, the terminals can generate high level pulse signal.
4	System bus interfaces (IN OUT)	Used for communication between instruments in multichannel operation and synchronized operation features.
5	AC power input socket	Used to connect AC power to start instrument, supports 110 V or 220 V.

1.7 Front Panel Menu Reference

This section lists the maps of all front panel menu, including Config menu, System menu, Protect menu and Function menu. For a brief tutorial, refer to [3.5 Use the Front Panel Menu](#).

1.7.1 Configuration Menu Reference

Press **[Shift]+[V-set]** (Config) to enter into the configuration menu interface.

Config	Configuration menu		
	Mode	Set the output priority mode	
		CV priority	Voltage priority mode
		CC priority	Current priority mode
	P-Set	Output power setting. When the actual output power reaches the set value, the power supply enters the CP constant power output mode.	
	V-Rise Time	Voltage rising time	When select CV priority, the menu shows the two items Range: 0.001~10; unit: second
	V-Fall Time	Voltage falling time	
	I-Rise Time	Current rising time	When select CC priority, the menu shows the two items Range: 0.001~10; unit: second
	I-Fall Time	Current falling time	
	On Delay	Set the output-on delay time Range: 0.000~10; unit: second	
	Off Delay	Set the output-off delay time Range: 0.000~10; unit: second	
Sense	Set the sense function state. <ul style="list-style-type: none"> Off: Turn the sense function off. 		

		<ul style="list-style-type: none"> On: Turn the sense function on. 						
	Bleeder	Set the Bleeder circuit state (When testing the battery, the user need to turn the Bleeder circuit off) <ul style="list-style-type: none"> On: Turn the Bleeder circuit on. Off: Turn the Bleeder circuit off. 						
	Trig Source	Set the trigger source						
		<table border="1"> <tr> <td>Keypad</td> <td>Keypad trigger, [Shift]+[On/Off] (Trigger)</td> </tr> <tr> <td>Bus</td> <td>Remote interface trigger command, like *TRG</td> </tr> <tr> <td>Ext</td> <td>External trigger, when the TRIG± interface state is set to IN and receive a high pulse signal, the instrument generates trigger.</td> </tr> </table>	Keypad	Keypad trigger, [Shift]+[On/Off] (Trigger)	Bus	Remote interface trigger command, like *TRG	Ext	External trigger, when the TRIG± interface state is set to IN and receive a high pulse signal, the instrument generates trigger.
Keypad	Keypad trigger, [Shift]+[On/Off] (Trigger)							
Bus	Remote interface trigger command, like *TRG							
Ext	External trigger, when the TRIG± interface state is set to IN and receive a high pulse signal, the instrument generates trigger.							

1.7.2 System Menu Reference

Press **[Shift]+[Display]** (System) to enter into the system menu interface.

System	System Menu							
	Beep	Set the key beeper state.						
		<table border="1"> <tr> <td>Off</td> <td>Turn the key beeper off.</td> </tr> <tr> <td>On</td> <td>Turn the key beeper on.</td> </tr> </table>	Off	Turn the key beeper off.	On	Turn the key beeper on.		
Off	Turn the key beeper off.							
On	Turn the key beeper on.							
	PowerOn	Select the power-on state.						
		<table border="1"> <tr> <td>Reset</td> <td>When the power supply is powered on, the power supply will initialize some settings and output state.</td> </tr> <tr> <td>Last</td> <td>When the power supply is powered on, the power supply will remain the same settings and output state as last time you turned off the power supply.</td> </tr> <tr> <td>Last+Off</td> <td>When the power supply is powered on, the power supply will remain the same settings as last time you turned off the power supply, but the output state is OFF state.</td> </tr> </table>	Reset	When the power supply is powered on, the power supply will initialize some settings and output state.	Last	When the power supply is powered on, the power supply will remain the same settings and output state as last time you turned off the power supply.	Last+Off	When the power supply is powered on, the power supply will remain the same settings as last time you turned off the power supply, but the output state is OFF state.
Reset	When the power supply is powered on, the power supply will initialize some settings and output state.							
Last	When the power supply is powered on, the power supply will remain the same settings and output state as last time you turned off the power supply.							
Last+Off	When the power supply is powered on, the power supply will remain the same settings as last time you turned off the power supply, but the output state is OFF state.							
	Connect	Set the working mode of the two channels of the instrument.						
		<table border="1"> <tr> <td>Single</td> <td>Configure the instrument to 2-channel independent output mode.</td> </tr> <tr> <td>Parallel</td> <td>Configure the instrument to 2-channel parallel mode.</td> </tr> <tr> <td>Series</td> <td>Configure the instrument to 2-channel series mode. It is forbidden to output more than 100V voltage after two channels are connected in series.</td> </tr> </table>	Single	Configure the instrument to 2-channel independent output mode.	Parallel	Configure the instrument to 2-channel parallel mode.	Series	Configure the instrument to 2-channel series mode. It is forbidden to output more than 100V voltage after two channels are connected in series.
Single	Configure the instrument to 2-channel independent output mode.							
Parallel	Configure the instrument to 2-channel parallel mode.							
Series	Configure the instrument to 2-channel series mode. It is forbidden to output more than 100V voltage after two channels are connected in series.							

	Comm	Set the communication information between instrument and PC. (The menu displays different interfaces information automatically based on the inserted communication board.)		
	None	No optional communication interfaces.		
	GPIB	When insert IT-E1205 communication board into expansion slot, the menu displays this information.		
		General purpose interface bus (GPIB) communication interface. Set the communication address within the range from 0 to 30.		
	USB+LAN	When insert IT-E1206 communication board into expansion slot, the menu displays this information.		
		Lan Info	View the LAN information.	
			<ul style="list-style-type: none"> • Status • IP Mode Status • IP Addr • Sub Net • Gateway • DNS1 (Primary address) • DNS2 (Secondary address) • MAC Addr • Host Name • Host Desc • Domain • TCPIP INSTR • Socket Port 	
		Lan Config	Configure LAN information.	
			IP Mode	Set IP mode.
				Auto: automatically configure the address of the instrument. Manual: manually configure the address of the instrument by entering values in the following six fields. The following information only appear when Manual is selected. <ul style="list-style-type: none"> • IP Addr • Sub Net • Gateway

				<ul style="list-style-type: none"> • DNS1 (Primary address) • DNS2 (Secondary address) • Socket Port 				
			Lan Restore	Select whether to reset the LAN to the default settings or not.				
				<ul style="list-style-type: none"> • NO • YES 				
			Lan Save	Select whether to save the LAN setting or not.				
				<ul style="list-style-type: none"> • NO • YES 				
		RS232 +CAN	When insert IT-E1207 communication board into expansion slot, the menu displays this information.					
			RS232	RS232 communication interface.				
				Display as the following format: baud rate_data bit_parity bit_stop bit. <ul style="list-style-type: none"> • Select the baud rate from the following options: 4800, 9600, 19200, 38400, 57600, 115200 • The data bit, parity bit and stop bit are fixed: 8_None_1 				
			CAN	CAN communication interface.				
				Select the baud rate from the following options: 20k, 40k, 50k, 80k, 100k, 125k, 150k, 200k, 250k, 400k, 500k, 1000k.				
				Set the instrument address to a number from 1 to 127.				
		Ext +RS485	When insert IT-E1208 communication board into expansion slot, the menu displays this information.					
			Ext-Program	Set external analog interface state. (External analog interface is optional.)				
				<table border="1"> <tr> <td>Off</td> <td>Turn the external analog function off.</td> </tr> <tr> <td>On</td> <td>Turn the external analog function on.</td> </tr> </table>	Off	Turn the external analog function off.	On	Turn the external analog function on.
Off	Turn the external analog function off.							
On	Turn the external analog function on.							
			RS485	RS485 communication interface.				
				Display as the following format: baud rate_data bit_parity bit_stop bit. <ul style="list-style-type: none"> • Select the baud rate from the following options: 4800, 9600, 19200, 38400, 57600, 115200. • The data bit, parity bit and stop bit are fixed: 8_None_1. 				

		RS485 Addr	RS485 communication address. Setting range: 0~127.	
Link	Set the instruments to synchronized operation mode.			
	Status	Set the synchronized state. Same function as the [Link] key.		
		Offline	Disable the Link function.	
		Online	Enable the Link function.	
	Mode	Set the synchronized mode.		
		On/Off Only	Set multiple units to output on/off and Save/Recall synchronization.	
		Track	Set multiple units to output on/off, Save/Recall synchronization and voltage proportional changing.	
			Reference	Set the voltage proportional relationship among multiple units.
		Duplicate	Set multiple units to output on/off synchronization, voltage/current setting value changing synchronization, Save/Recall synchronization, priority mode synchronization, voltage/current rising/falling synchronization and Protect menu function synchronization.	
Chan Number	Set channel number value: 1, 3, 5, 7, 9, 11, 13, 15.			
Ext IO	Set the rear panel interface TRIG± function.			
	Trig Out	When the trigger source is set to Keypad or Bus and the trigger happens, the TRIG± interface generates a high pulse trigger signal.		
	Trig In	When the trigger source is set to Ext , inputting a high pulse trigger signal through TRIG± interface can trigger the instrument		
	Sync Out	By default, it is used as the indicator signal of the output state of the instrument. Channels can be selected via submenus. <ul style="list-style-type: none"> • CH1: Select channel 1. • CH2: Select channel 2. The On/Off light is off, the pin outputs 0V low level; the On/Off light is on, the pin outputs 5V high level.		
	Sync In	Used to control the output state of the instrument. Channels can be selected via submenus. <ul style="list-style-type: none"> • CH1: Select channel 1. • CH2: Select channel 2. When the pin inputs 0V low level, the On/Off light is off; when the pin inputs 5V high level, the On/Off light is on.		
System Reset	Select whether to restore the factory default settings or not.			

		NO	Don't restore the factory default settings.		
		YES	Restore the factory default settings.		
	System Info	View the system information.			
		Model	Display the instrument model.		
		Version	Instrument version information.		
			Main	Display the main firmware version.	
			Comm	Display the communication board version.	
			Sub1	Display the version of the control board for channel 1.	
			Sub2	Display the version of the control board for channel 2.	
		SN	Display the serial number.		
Last Cal	Display last calibration date.				

1.7.3 Protect Function Menu Reference

Press **[Shift]+[Esc]** (Protect) to enter into the protect menu interface.

Protect	Protection function menu			
	U-Max	The maximum output voltage setting value.		
	U-Min	The minimum output voltage setting value		
	OVP	Over-voltage protection.		
		Off	Turn the OVP function off.	
		On	Turn the OVP function on.	
			Level	Over-voltage limit.
			Delay	Delay time.
	OCP	Over-current protection.		
		Off	Turn the OCP function off.	
		On	Turn the OCP function on.	
			Level	Over-current limit.
			Delay	Delay time.
	OPP	Over-power protection.		
		Off	Turn the OPP function off.	
		On	Turn the OPP function on.	

		Level	Over-power limit.
		Delay	Delay time.
	Foldback	Set foldback function	
		Off	Turn off the FOLDBACK function
		CV	Foldback protection is triggered when the power loop is switched to CV.
		Delay	Delay time.
		CC	Foldback protection is triggered when the power loop is switched to CC.
		Delay	Delay time.

1.7.4 Advanced Function Menu Reference

Press **[Shift]+[I-set]** (Function) to enter into the function menu interface.

The main functions of function menu are listed in the table below. Please refer to the corresponding sections for the detailed information about each function.

Function	Function menu	
	List	4.7 List Function

1.8 Models and Options

IT-M3100D series models

Model	Voltage	Current	Power
IT-M3131D	30V	15A	200W
IT-M3141D	30V	15A	400W
IT-M3132D	60V	10A	200W
IT-M3142D	60V	10A	400W

Options

You can purchase accessories for this series of instruments separately, including the following:

- **Scalable interface**

The interface expansion slot provided on the rear panel of the instrument allows users to flexibly expand according to their needs. Different interface cards can be selected to achieve different functions. Includes communication interface or external analog interface.

- **Cabinet installation**

This series instruments can be mounted on a standard 19-inch cabinet. ITECH has prepared a special bracket for the user as a mounting kit.

The detailed descriptions of the options are as follows.

Note

The following optional accessories from ITECH are sold separately. Users need to purchase separately.

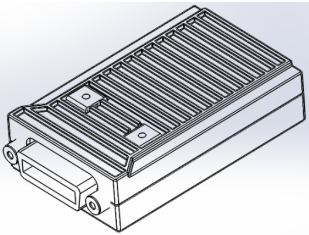
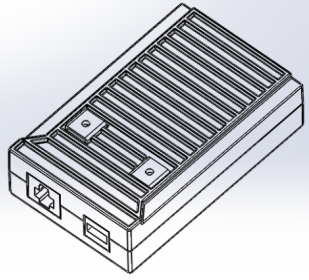
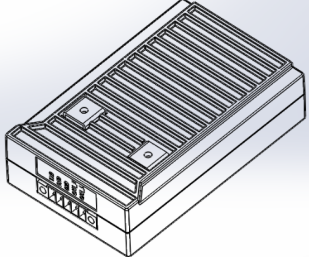
Device Name	Model	Description	Type
GPIB communication interface 	IT-E1205	When the user needs to use GPIB interface to enable remote operation, this option is the right choice.	Optional
USB / LAN communication interface 	IT-E1206	When the user needs to use USB or LAN interface to enable remote operation, this option is the right choice.	Optional
RS-232 / CAN communication interface 	IT-E1207	When the user needs to use RS-232 or CAN interface to enable remote operation, this option is the right choice.	Optional

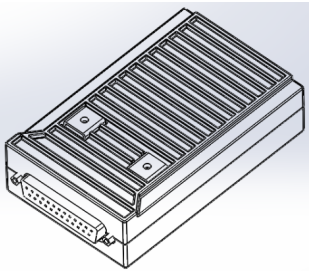
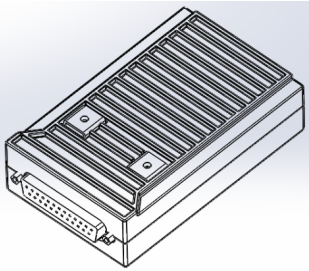
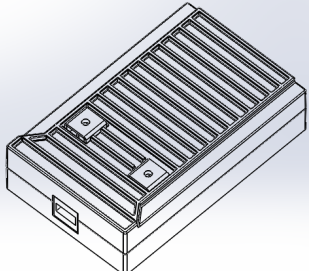
Device Name	Model	Description	Type
Single Channel External analog / RS485 communication interface 	IT-E1208	When the user needs to use RS-485 to enable remote operation or single channel external analog function, this option is the right choice.	Optional
Dual Channel External analog / RS485 communication interface 	IT-E1208D	When the user needs to use RS-485 to enable remote operation or dual channel external analog function, this option is the right choice.	Optional Only applicable to the IT-M3100D series.
USB communication interface 	IT-E1209	When the user needs to use USB interface to enable remote operation, this option is the right choice.	Optional
Cabinet installation kit	IT-E154 series	When the instrument needs to be installed in cabinet, this kit is needed. Please refer to <i>«IT-E154 User Manual»</i> for detailed description about the installation method.	Optional

WARNING

It is strictly forbidden to directly insert and remove the communication card when the instrument is powered. Power off the instrument before installing the communication card. After the communication card is installed, power on the instrument. At this time, the instrument takes about 30 seconds to update the communication board automatically.

2 Inspection and Installation

- ◆ Verifying the Shipment
- ◆ Instrument Size Introduction
- ◆ Rack Mounting
- ◆ Stacking Instruments
- ◆ Connecting the Power Cord
- ◆ Connecting the Device Under Test (DUT)
- ◆ Connect the Communication Interface

2.1 Verifying the Shipment

Unpack the box and check the contents before operating the instrument. If wrong items have been delivered, if items are missing, or if there is a defect with the appearance of the items, contact the dealer from which you purchased the instrument immediately.

The package contents include:

Item	Qty.	Model	Remarks
Programmable DC Power Supply	X 1	IT-M3100D series	Please refer to 1.8 Models and Options for the detailed models.
Power Cord	X 1	-	User may select an appropriate power cord that matches the specifications of power socket used in the area. See the Section 2.5 Connecting the Power Cord for details.
Multiple instruments connection cables	X 1	IT-E251	When the user needs to connect the System Bus interfaces between Multiple instruments in multichannel operation and synchronized operation features, this cable is the right choice.
Calibration Certificate	X 1	-	It is the calibration certificate of the instrument before delivery.



Note

Upon verification of the shipment, keep the package and relevant contents thereof in a safe place. When returning the instrument for warranty service or repair, the specified packing requirements shall be met.

2.2 Instrument Size Introduction

The instrument should be installed at well-ventilated and rational-sized space. Please select appropriate space for installation based on the power supply size.

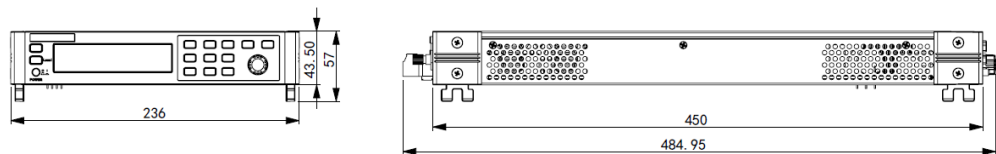
The detailed sizes are shown as below.



2.3 Rack Mounting

This instrument can be installed on standard 19-inch rack. ITECH provides user with optional mount kit IT-E154. The detailed operation please refer to the **IT-E154 User Manual** of your mount kit.

WARNING

When installing the device in a rack, do not block the ventilation holes of the instrument and reserve appropriate air ducts to maximize heat dissipation.

The ventilation hole locations for this series of instruments are shown in the figure below.



Note

The actual positions of the terminals on the rear panel are subject to the device. The diagram below is used only to demonstrate the function of the ventilation holes.

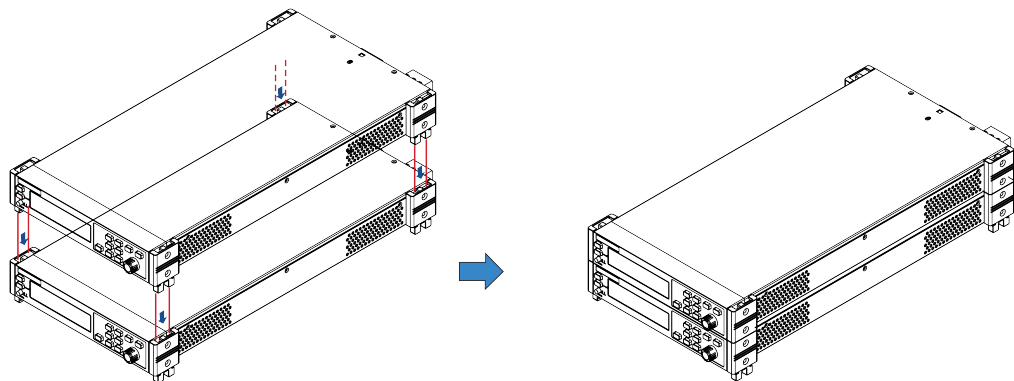

2.4 Stacking Instruments

This series power supply adopts patented appearance design with a side ventilation structure. Thanks to the flexible modular architecture, the instruments can be directly and easily stacked on the desk without purchasing any accessories. A maximum of 10 instruments can be stacked. The stacking schematic diagram is as shown below.



2.5 Connecting the Power Cord

Precautions

To prevent electric shock and damage to the instrument, observe the following precautions.

WARNING

- The power cords supplied with this product is certified for safety. In case the supplied lines assembly needs to be replaced, or an extension lines must be added, be sure that it can meet the required power ratings of this product. Any misuse voids the warranty of this product.
- Before connecting power cord, be sure to confirm that the power voltage matches with the supply voltage.
- Before connecting power cord, be sure to switch off the instrument. Power switch is in Off position.
- To avoid fire or electric shock, make sure to use the power cord supplied by ITECH.
- Do not use an extended power cord without protective grounding, otherwise the protection function will fail.
- Be sure to connect the main power socket to the power outlet with protective grounding. Do not use terminal board without protective grounding.

Categories of Power Cords

The standard power cord types are as follows. Please select appropriate power cords appropriate to local voltage based on the specifications of power cords below. If purchased model fails to meet local voltage requirements, please contact distributor or factory for change.

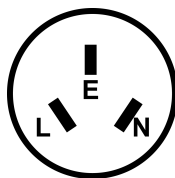

China
IT-E171

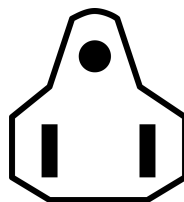

United States &
Canada & Japan
IT-E172

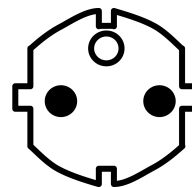

Europe
IT-E173

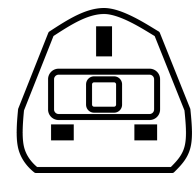

England
IT-E174

AC Power Input Level

This series power supply operate at the following AC power input.

- **Voltage 1:** 176V to 264V, 47 to 63 Hz
- **Voltage 2:** 99V to 121V, 47 to 63 Hz



Note

When IT-M3141D/IT-M3142D works at **Voltage 2**, the total output power of 2 channels in parallel is limited, and can only reach 600W after parallel connection. To achieve full power output, please use the input voltage of **Voltage 1**. For more information, please refer to the specifications of the corresponding model.

Connecting the Power Cord

To connect the power cord:

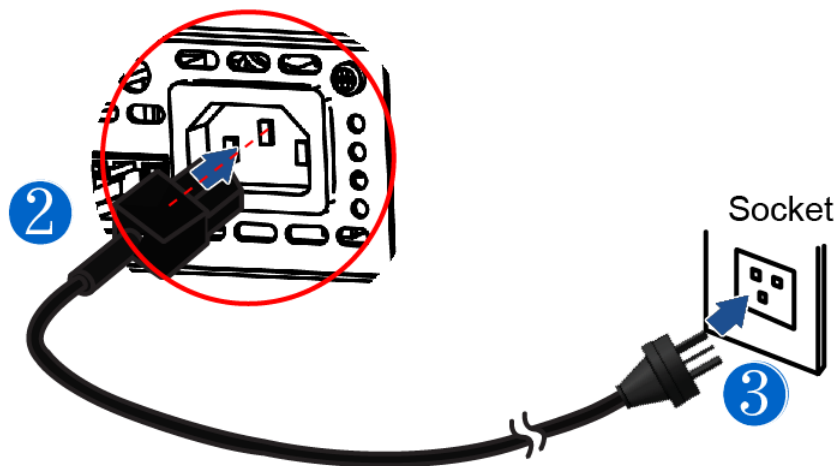
1. Make sure that the front-panel power switch is in the OFF position.
2. Connect the female end of the supplied line cord to the AC receptacle on the rear panel.
3. Connect the plug of the power cord to a grounded AC outlet.



2.6 Connecting the Device Under Test (DUT)

The instrument supports two connection methods between power supply and DUT: Local measurement and Remote sensing. This series power supplies include built-in circuit that connect or disconnect the \pm sense terminals from their corresponding \pm output terminals. As shipped, the sense terminals are internally connected to the output terminals. This is referred to as Local measurement. If you need to use remote sensing, after making the connection, be sure to turn the sense function on. Please refer to [4.1.3 Set the Sense Function State](#) for the detailed operations.

Precautions

To prevent electric shock and damage to the instrument, observe the following precautions.

WARNING

- Before connecting test cables, be sure to switch off the power supply. Power switch is in Off position, otherwise touching the output terminals on the rear panel may result in personal injury or death due to electric shock.
 - To avoid electrical shock, before testing, please make sure the rating values of the testing cables, and do not measure the current that higher than the rating value. All test cables shall be capable of withstanding the maximum short circuit output current of the power supply without causing overheat.
 - If several loads are provided, each pair of load wires shall safely withstand the rated short circuit output current of the power supply under full load.
 - To avoid battery short circuit, be sure to check that the test line end is not connected when connecting or disassembling the test line. When the test line end is connected with battery, short circuit may cause severe accident.
 - Please check that the test cables can withstand maximum current.
 - During wiring, check that the anode and cathode of the test lines are properly and tightly connected; anode ON and cathode OFF are prohibited.
 - If you need to pull out the green output terminal, please lift it up and pull it out, otherwise it will damage the instrument.
-

Specification

Test cables are not standard accessories for the instrument. Please select optional red and black test cables for individual sales based on the maximum current value. For specifications of test cables and maximum current values, refer to [A.1 Appendix→Specifications of Red and Black Test Lines](#) for more information.

Local Measurement

The connection diagram and steps of local sensing are as follows.

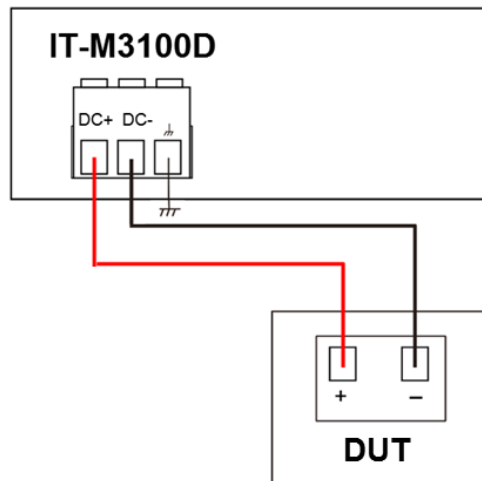

1. Remove the output terminal cover.
2. Loosen the screws of the output terminals and connect the red and black test cables to the output terminals, and connect the ground terminal correctly. Re-tighten the screws.

When maximum current that one test cable can withstand fails to meet the current rated current, use multiple pieces of red and black test cables. For example, the maximum current is 1,200 A, then 4 pieces of 360 A red and black cables are required.

3. Thread the test cables through the output terminals cover and install the cover.
4. Connect the other end of the red and black cables to the DUT. The positive and negative poles must be properly connected and fastened when wiring.

Remote Sensing

When the DUT consumes large current or the wires are too long, there is a voltage drop on the wires between the DUT and output terminal of the power supply. To maximize measurement accuracy, you can use remote sense wire connections to monitor and improve the voltage adjustment on the DUT and compensate for the voltage drop on the wires .

When the power supply is used for measuring battery charge in actual applications, the voltage drop of the wire will lead to voltage inconsistency of both ends and inconsistency of the cutoff voltage of power supply and the actual voltage of battery, resulting in inaccurate measurement.

The connection diagram and steps of remote sensing are as follows.

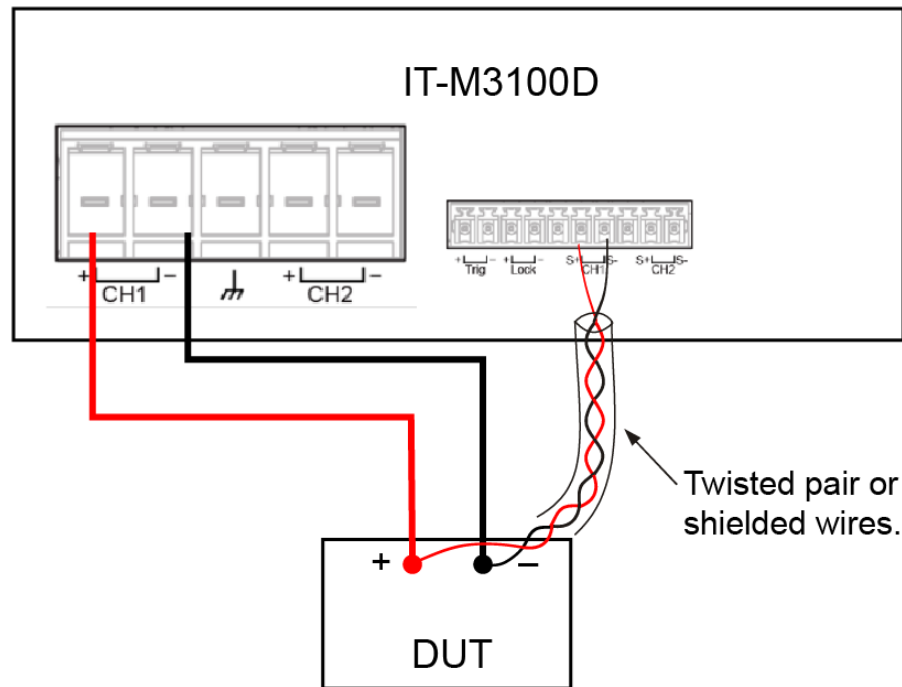
Note

To ensure the stability of the system, use shielded twisted-pair cables between the remote sense terminals and the equipment under test.

1. Remove the output terminal cover.
2. Loosen the screws of the output terminals and connect the red and black test cables to the output terminals, and connect the ground terminal correctly. Re-tighten the screws.

When maximum current that one test cable can withstand fails to meet the current rated current, use multiple pieces of red and black test cables. For example, the maximum current is 1,200 A, then 4 pieces of 360 A red and black cables are required.

3. Refer to the wiring diagram, and use shielded twisted-pair cables to connect the remote sense terminals and the equipment under test.
4. Thread the red and black test cables and sense cables through the output terminals cover and install the cover.
5. Connect the other end of the remote sense cables and the red and black cables to the DUT. The positive and negative poles must be properly connected and fastened when wiring.
6. Power on the instrument and turn the sense function on. Please refer to [4.1.3 Set the Sense Function State](#) for the detailed operations.

2.7 Connect the Communication Interface

This series power supply has no standard-equipped communication interfaces. Users can purchase communication cards separately. Users can choose one of

RS-232, USB, GPIB, RS-485, LAN, CAN to communicate with the computer. For details, see [1.8 Models and Options](#).

The reserved communication card installation slot is on the rear panel of the instrument. Users can install it after purchasing the communication card.

CAUTION

- **It is strictly forbidden to directly insert and remove the communication card when the instrument is powered. Power off the instrument before installing the communication card. After the communication card is installed, power on the instrument. At this time, the instrument takes about 30 seconds to update the communication board automatically.**
- **Always follow the ESD rules to insert the interface card into the slot.**
- **Except the communication card, do not insert other hardware to this slot.**
- **If no communication card is used, it is recommended to install the plastic plug to prevent the interior from getting dirty, and to avoid the change of air circulation direction.**

The installing steps for the purchased communication card are as follows:

1. Power off the instrument.
2. Remove the plug of the rear panel interface.
 - a. Use a small flat screwdriver to press the clip at the upper cover opening.
 - b. At the same time, use another small flat screwdriver to stir the slots one by one from another opening of the upper cover, and push the plastic plug out.

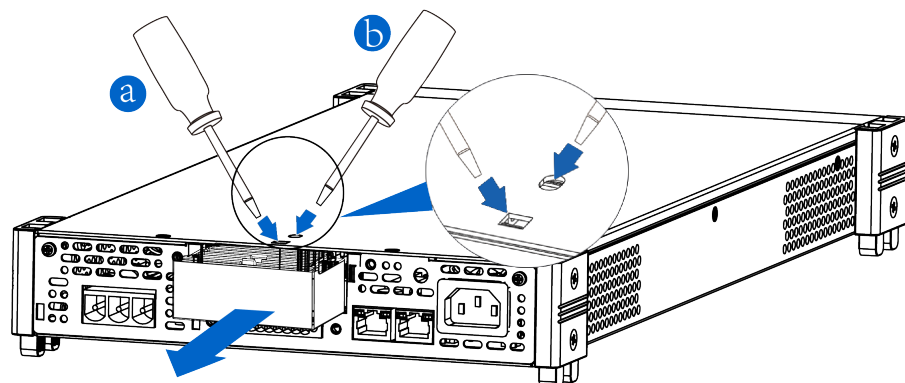



Note

The above picture is only used to demonstrate the installation process of the communication box. The actual appearance of the rear panel of the power supply should be subject to the actual product.

3. Install the purchased communication card.
 - a. Use a screwdriver to unscrew the screws above the communication card.
 - b. Push the communication card into the instrument slot.
 - c. Use the screwdriver and screws to lock the instrument and the communication card.
4. After the communication card is installed successfully, power on the instrument.

2.7.1 USB Interface

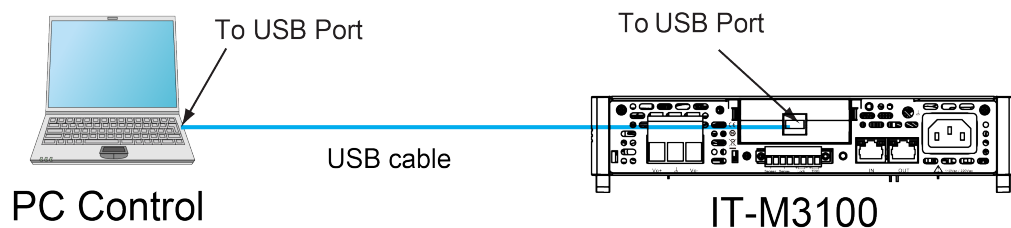
When the optional interface card is a stand-alone USB interface (IT-E1209) or USB+LAN interface (IT-E1206), the following can help users quickly understand the steps required to connect the USB interface. The figure below shows a typical USB interface system.

Note

- Take the IT-E1209 communication card box as an example. If you install IT-E1206, please refer to the actual interface position.
- The rear panel shown in the figure is only an example. The actual appearance of the rear panel is subject to the specific instrument.

This series of power supply USB interfaces include the following two types, which do not need to be set in the menu, and can be operated remotely after installing the driver and connecting the USB communication cable.

- TMC: USB_TMC type interface, you need to install the NI-VISA driver adapted to the computer operating system version. Please download the driver from the NI official website. After the driver is installed successfully, it will be recognized as the USB device address in the computer device manager. As below.

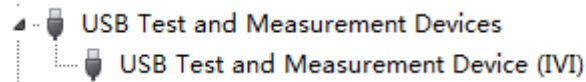

- VCP: Virtual serial port. The Win7 version of the operating system needs to install the supporting driver. Please download the driver from the ITECH official website or contact the ITECH technical support personnel to obtain it. The operating system of Win10 and above does not need to install the driver. Recognized as a COM port in the computer's device manager. As below.

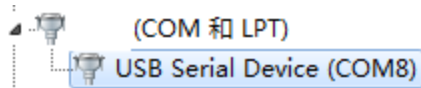

If both of the above interfaces are successfully driven, the computer device manager will display both interfaces, as shown in the following figure. The user can select any interface on the software interface to add equipment.

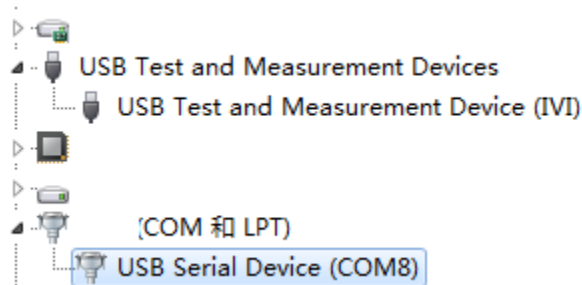

2.7.2 LAN Interface

When the user's optional interface card is a LAN+USB interface (IT-E1206), the following is required to use the LAN interface.

LAN Connection

Use the following steps to quickly connect your instrument to your LAN and configure it. Two typical LAN interface systems are described below: private LAN and site LAN.

- **Connect to the private LAN**

A private LAN is a network in which LAN-enabled instruments and computers are directly connected. They are typically small, with no centrally managed resources. When connected to a computer, a direct attached network cable can be used to connect directly to the computer via the LAN interface.

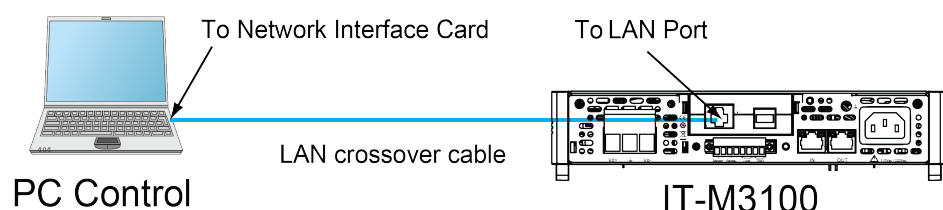

- **Connect to the site LAN**

A site LAN is a local area network in which LAN-enabled instruments and computers are connected to the network through routers, hubs, and/or switches. They are typically large, centrally-managed networks with services such as DHCP and DNS servers. When connected to a computer, a direct attached network cable can be used to connect to the router, and the computer is also connected to the router.

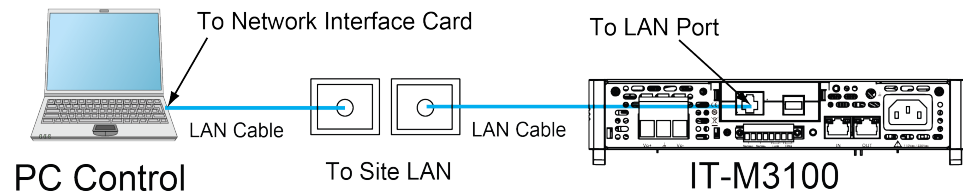
 **Note**

- When using one crossover cable to connect PC directly, the gateway address should be consistent with that of the PC, and the IP address should be at the same network segment with the PC's IP address.
- When the instrument and computer are connected to the router, an independent IP address must be assigned for the instrument.

LAN Status Indicator

The lower icon notes the two status LEDs located at the bottom of the LAN port.

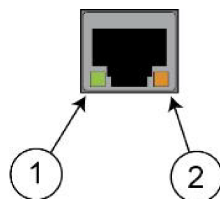

If neither of the LEDs is lit, the network is not connected.

- Position 1: When lit, it indicates that the LAN port is connected.
- Position 2: When flashing, it indicates that the LAN port is receiving or sending a message.

Configure LAN Interface Information

When shipped, DHCP is on, which may enable communication over LAN. The letters DHCP stands for Dynamic Host Configuration Protocol, a protocol for assigning dynamic IP addresses to devices on a network. With dynamic addressing, a device can have a different IP address every time it connects to the network. The user can view the related information of LAN interface or configure the communication parameters in system menu.

- Automatically configure the address of the instrument.(Auto)

When selected, the instrument will first try to obtain an IP address from a DHCP server. If a DHCP server is found, the DHCP server will assign an IP address, Subnet Mask, and Default Gateway to the instrument. If a DHCP server is unavailable, the instrument will try to obtain an IP address using AutoIP. AutoIP automatically assigns an IP address, Subnet Mask, and Default Gateway addresses on networks that do not have a DHCP server.

- Manually configure the address of the instrument.(Manual)

Set the following parameter. The following information only appear when Manual is selected.

- IP Addr: This value is the Internet Protocol (IP) address of the instrument. An IP address is required for all IP and TCP/IP communications with the instrument. An IP Address consists of 4 decimal numbers separated by periods. Each decimal number ranges from 0 through 255 with no leading zeros (for example, 169.254.2.20).
- Sub Net: This value is used to enable the instrument to determine if a client IP address is on the same local subnet. The same numbering notation applies as for the IP Address. When a client IP address is on a different subnet, all packets must be sent to the Default Gateway.
- Gateway: This value is the IP Address of the default gateway that allows the instrument to communicate with systems that are not on the local subnet, as determined by the subnet mask setting. The same numbering notation applies as for the IP Address. A value of 0.0.0.0 indicates that no default gateway is defined.
- DNS1: This field enters the primary address of the server. Contact your LAN administrator for server details. The same numbering notation applies as for the IP Address. A value of 0.0.0.0 indicates that no default server is defined.

DNS is an internet service that translates domain names into IP addresses. It is also needed for the instrument to find and display its host-name assigned by the network. Normally, DHCP discovers the DNS address information; you only need to change this if DHCP is unused or not functional.

- DNS2: This field enters the secondary address of the server. Contact your LAN administrator for server details. The same numbering notation applies as for the IP Address. A value of 0.0.0.0 indicates that no default server is defined.
- Socket Port: This field indicates the port number corresponding to the RawSocket service.

The operation steps to configure are as follows.

1. Press **[Shift]+[Display]** (System) to enter into the system menu interface.
2. Use left and right keys or rotate the knob to select **Comm** and press **[Enter]** key to confirm.
3. Use left and right keys or rotate the knob to select **LAN** and press **[Enter]** key to confirm.
4. Use left and right keys or rotate the knob to select **Lan Config** and press **[Enter]** key to confirm.
The first displayed menu item **IP Mode** is to configure the instrument address.
5. Press **[Enter]** key to confirm. This parameter is in modification.
 - Auto: automatically configure the addressing of the instrument;
 - Manual: manually configure the addressing of the instrument.
If Manual is selected, set the parameters such as IP Addr and Sub Net.
6. After setting, press **[Esc]** to exit.

Confirm the LAN Setting

After configuring the LAN settings, the user need to confirm the settings to make it valid in the instrument. The operation steps to confirm the LAN settings are as follows.

1. Press **[Shift]+[Display]** (System) to enter into the system menu interface.
2. Use left and right keys or rotate the knob to select **Comm** and press **[Enter]** key to confirm.
3. Use left and right keys or rotate the knob to select **LAN** and press **[Enter]** key to confirm.
4. Use left and right keys or rotate the knob to select **Lan Save** and press **[Enter]** key to confirm.
 - NO: indicates refuse to save the LAN setting.
 - YES: indicates save the LAN setting.
5. After setting, press **[Esc]** to exit.

Reset the LAN to the Default Settings

The operation steps to reset the LAN to the default settings are as follows.

1. Press **[Shift]+[Display]** (System) to enter into the system menu interface.
2. Use left and right keys or rotate the knob to select **Comm** and press **[Enter]** key to confirm.
3. Use left and right keys or rotate the knob to select **LAN** and press **[Enter]** key to confirm.
4. Use left and right keys or rotate the knob to select **Lan Restore** and press **[Enter]** key to confirm.
 - NO: indicates refuse to reset the LAN to the default settings.

- YES: indicates reset the LAN to the default settings.
5. After setting, press **[Esc]** to exit.

View LAN Interface Information

The operation steps to view the LAN interface information are as follows.

1. Press **[Shift]+[Display]** (System) to enter into the system menu interface.
2. Use left and right keys or rotate the knob to select **Comm** and press **[Enter]** key to confirm.
3. Use left and right keys or rotate the knob to select **LAN** and press **[Enter]** key to confirm.

The first displayed menu item **Lan Info** is to view the LAN interface information.

4. Press **[Enter]** key to confirm.
5. Use left and right keys or rotate the knob to view the LAN interface information. Refer to [System Menu](#) for more information.
6. After setting, press **[Esc]** to exit.

2.7.2.1 Web Interface

The instrument has a built-in Web interface for monitoring and controlling the instrument via a Web browser. To use the Web interface, connect the instrument and PC over LAN and enter the instrument's IP address into the address bar at the top of your PC's Web browser, you can access the front panel control functions including the LAN configuration parameters.

The address format to be entered in the browser's address bar is: `http://192.168.200.100`

192.168.200.100 is the default IP address. If it has been changed by the user, replace this IP with the actual configuration found in the instrument's Communication Menu.



Note

The instrument supports simultaneous connection to up to 6 computers. If there are more connections, the instrument performance will be reduced.

As shipped, the login password of the Web interface defaults to 12345678. To change the password, click the Security button in the navigation bar on the left side of the window after login.

Enter the password and then click the LOGIN button, the Web interface will appear in the browser as shown below. The following figure is just as an example and the Web interface of different models are different. The actual shown page shall be subject to the connected instrument.

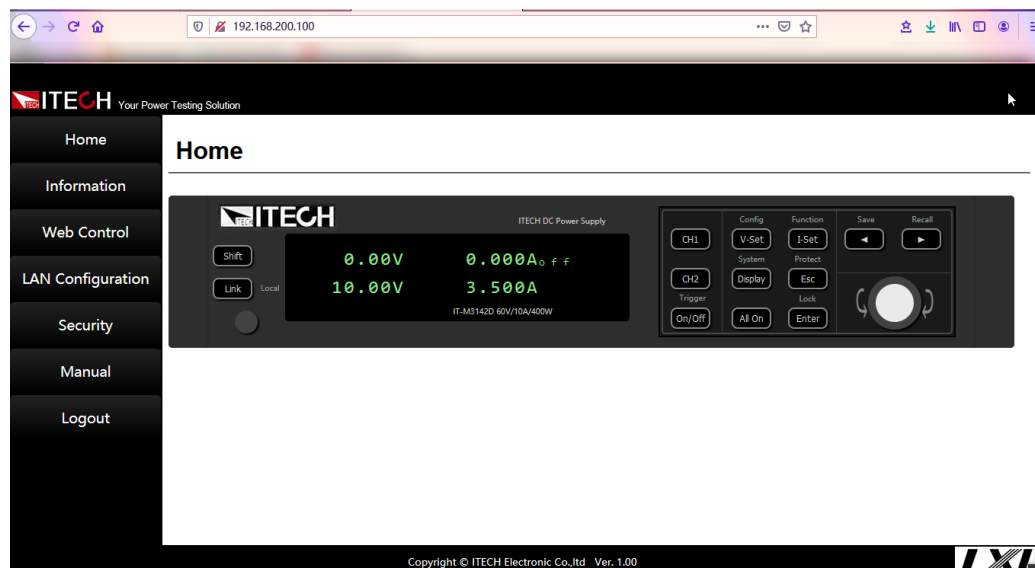

You can select different interfaces by clicking the seven buttons shown in the navigation bar on the left side of the window. The detailed descriptions are as follows.

- Home: Web home interface, displays the model and appearance of the instrument;
- Information: displays the serial number of the instrument and more system information as well as LAN configuration parameters;
- Web Control: enables the Web control to begin controlling the instrument. This page allows you to monitor and control the instrument;
- LAN Configuration: reconfigure the LAN parameters;
- Security: change the password and control access to the Web interface;
- Manual: go to the ITECH official website and view or download the relevant documents;
- Logout: logout the Web interface.

2.7.2.2 Using Sockets

CAUTION

The instruments allow up to six simultaneous socket connections to be made.

ITECH instruments have SCPI socket services, which can be used to send and receive SCPI commands, queries, and query responses. All commands must be terminated with a newline for the message to be parsed. All query responses will also be terminated with a newline.

2.7.3 CAN Interface

When the optional interface card is RS232+CAN interface (IT-E1207), the following can help users quickly understand the steps required to connect to the CAN interface.

The following figure shows the CAN interface system. The user can select the CAN interface converter to connect to your computer according to the actual situation. Take the CAN to USB interface device as an example.

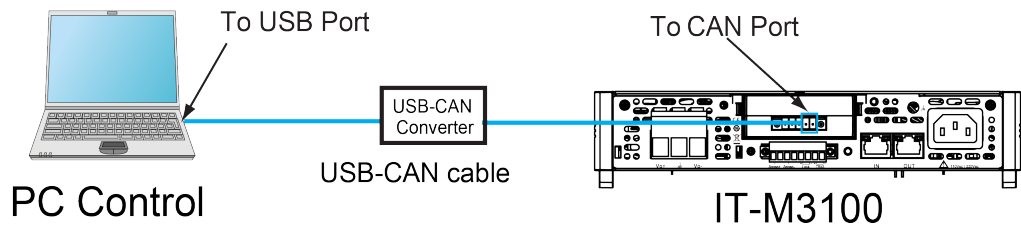

Note

The rear panel shown in the figure is only an example. The actual appearance of the rear panel is subject to the specific instrument.

Definition of CAN Pins

The definition of CAN pins are as follows.

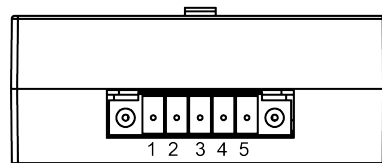

IT-E1207

Pin	Description
1	TXD, transmit data
2	RXD, receive data
3	GND
4	CAN_H
5	CAN_L

CAN Configuration

The user needs to configure the CAN interface parameters in the system menu before using the remote control. The CAN interface parameters are as follows.

Name	Description
Baud rate	Select the baud rate from the following options: 20k, 40k, 50k, 80k, 100k, 125k, 150k, 200k, 250k, 400k, 500k, 1000k.
Instrument Address	Range: 1 to 127

The operation steps are as follows.

1. Press **[Shift]+[Display]** (System) to enter into the system menu interface.
2. Use left and right keys or rotate the knob to select **Comm** and press **[Enter]** key to confirm.
3. Use left and right keys or rotate the knob to select **CAN** and press **[Enter]** key to confirm.
4. Use left and right keys or rotate the knob to select **Baud rate** and press **[Enter]** key to confirm.
5. Rotate the knob to set the baud rate and press **[Enter]** key to confirm.
6. Use left and right keys or rotate the knob to select **Address** and press **[Enter]** key to confirm.
7. Rotate the knob to set the communication address and press **[Enter]** key to confirm.
8. After finishing the setting, press **[Esc]** to exit.

CAN Troubleshooting

If you meet some problems when communicating with PC by CAN interface, please check the following items:

- PC and power supply must have the same baud rate.
- Ensure you have used the correct communication cable (CAN_H, CAN_L). Please pay attention that some cable may not have a correct internal wiring even it is with an appropriate interface.
- The interface cable is correctly connected (CAN_H to CAN_H, CAN_L to CAN_L)
- If the communication signal is poor or unstable, it is recommended to connect a 120 Ω terminating resistance.
 - The connection diagram of a single device is as below.

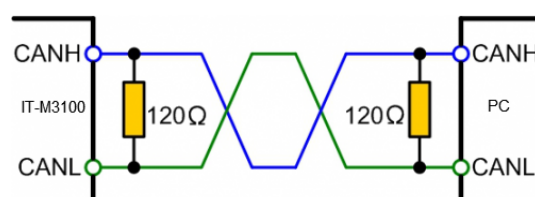

- The connection diagram of multiple devices is as below.

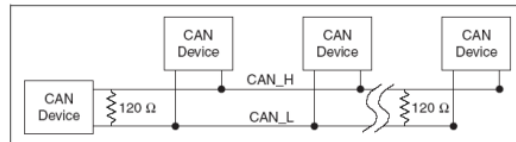

2.7.4 GPIB Interface

When the optional interface card is a GPIB interface (IT-E1205), you need to know the following.

Each device on the GPIB (IEEE-488) interface must have a unique whole number address between 0 and 30. Your computer's GPIB interface card address must not conflict with any instrument on the interface bus. This setting is non-volatile; it will not be changed by power cycling or *RST. The figure below shows a typical GPIB interface system.

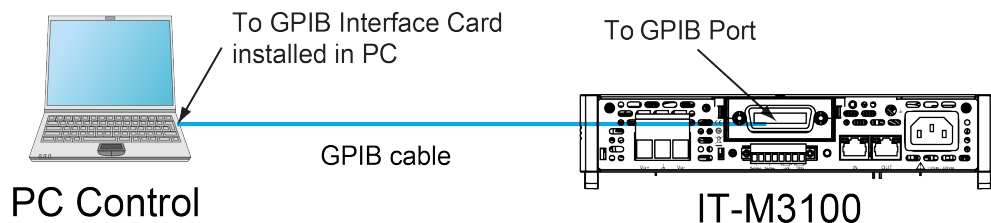

Note

The rear panel shown in the figure is only an example. The actual appearance of the rear panel is subject to the specific instrument.

You can change the GPIB address in the system menu. The operation steps are as follows.

1. Refer to the GPIB connection diagram, Connect the power supply and the computer using a IEEE-488 bus.
2. Set the GPIB address in the system menu.
 - a. Press **[Shift]+[Display]** (System) to enter into the system menu interface.
 - b. Use left and right keys or rotate the knob to select **Comm** and press **[Enter]** key to confirm.
 - c. Use left and right keys or rotate the knob to select **GPIB** and press **[Enter]** key to confirm.
 - d. Rotate the knob to adjust the GPIB address and press **[Enter]** key to confirm.
 - e. After finishing the setting, press **[Esc]** to exit.

2.7.5 RS-232 Interface

When the optional interface card is RS232+CAN interface (IT-E1207), the following can help users quickly understand the steps required to connect the RS-232 interface. The diagram below illustrates a typical RS-232 interface system, where the instrument is connected to a PC using a standard RS-232 cable (with a DB9 connector on one end and a straight terminal block on the other). The standard cable is described as follows:

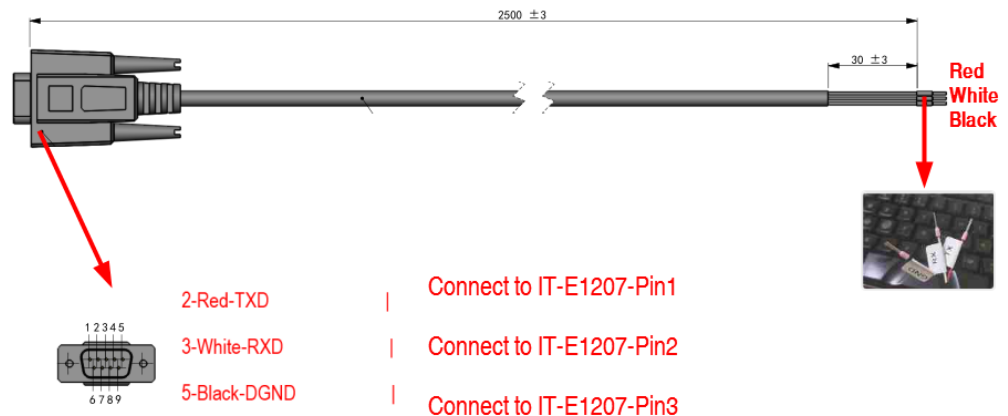

Wiring Method:

- TXD cable (red) connects to Pin 1 of the IT-E1207 board.
- RXD cable (white) connects to Pin 2 of the IT-E1207 board.
- DGND cable (black) connects to Pin 3 of the IT-E1207 board.

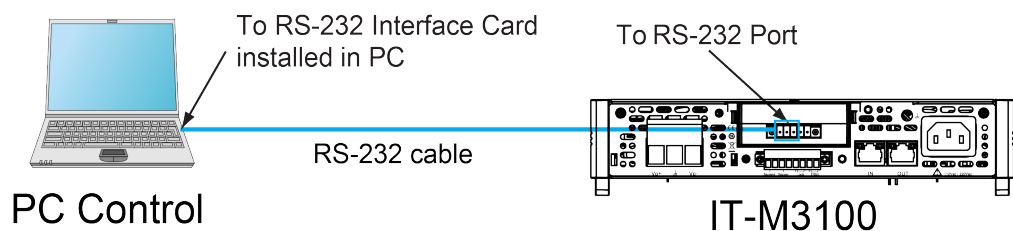

Note

The rear panel shown in the figure is only an example. The actual appearance of the rear panel is subject to the specific instrument.

Definition of RS-232 Pins

The definition of RS-232 pins are as follows.

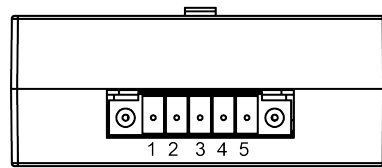

IT-E1207

Pin	Description
1	TXD, transmit data
2	RXD, receive data
3	GND
4	CAN_H
5	CAN_L

RS-232 Connection

The connection principle with the computer is shown in the following diagram:

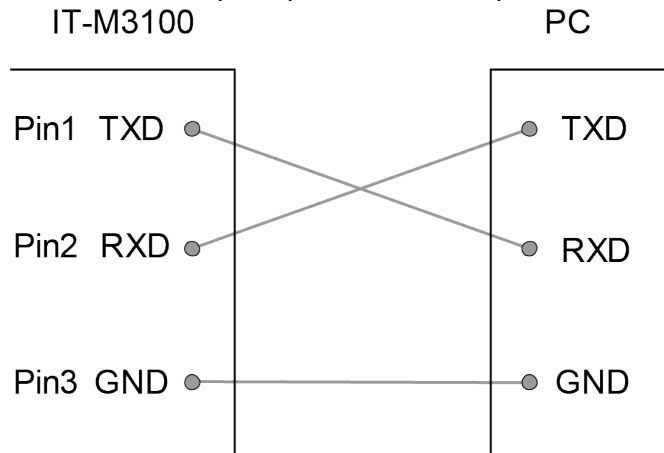

RS-232 Configuration

The user needs to configure the RS-232 interface parameters in the system menu before using the remote control. The RS-232 interface parameters are as follows.

Name	Description
Baud rate	Select the baud rate from the following options: 4800, 9600, 19200, 38400, 57600, 115200
Data Bit	8 (fixed)
parity bit	None (fixed)
stop bit	1 (fixed)

The operation steps are as follows.

1. Press **[Shift]+[Display]** (System) to enter into the system menu interface.

2. Use left and right keys or rotate the knob to select **Comm** and press **[Enter]** key to confirm.
3. Use left and right keys or rotate the knob to select **RS232** and press **[Enter]** key to confirm.

RS232

9600_8_None_1

4. Rotate the knob to set the baud rate.
5. After finishing the setting, press **[Esc]** to exit.

RS-232 Troubleshooting

If you meet some problems when communicating with PC by RS-232 interface, please check the following items:

- PC and power supply must have the same baud rate.
- Ensure you have used the correct communication cable. Please pay attention that some cable may not have a correct internal wiring even it is with an appropriate interface.
- The cable must be connected to the correct serial ports (COM1, COM2, etc) of PC.

2.7.6 RS-485 Interface

When the optional interface card is a DB25 analog interface (IT-E1208 or IT-E1208D) with RS-485 interface, you can quickly understand the steps required to connect the RS-485 interface.

The following figure shows a typical RS-485 interface system. Users can select the RS-485 interface converter to connect to your computer according to the actual situation, for example: RS-485 to RS-232 interface device or RS-485 to USB interface device Etc., the RS-485 to USB interface device is taken as an example.

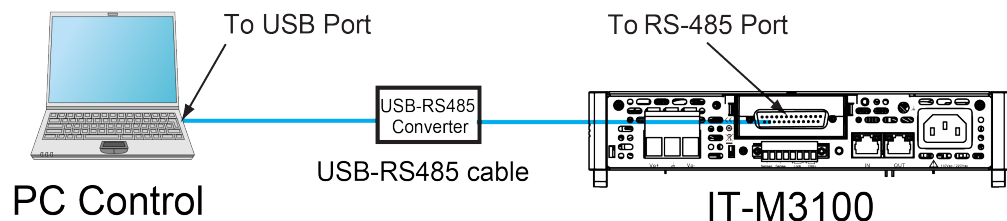

Note

The rear panel shown in the figure is only an example. The actual appearance of the rear panel is subject to the specific instrument.

Definition of RS-485 Pins

RS-485 interface pins are integrated in the DB25 analog interface. Pin25 and Pin13 are the A and B pins for RS-485. Refer to [Analog interface](#) for more information.

RS-485 Configuration

The user needs to configure the RS-485 interface parameters in the system menu before using the remote control. The RS-485 interface parameters are as follows.

Name	Description
Baud rate	Select the baud rate from the following options: 4800, 9600, 19200, 38400, 57600, 115200
Address	Set the communication address, range: 0~127.
Data Bit	8 (fixed)
Parity bit	None (fixed)
Stop bit	1 (fixed)

The operation steps are as follows.

1. Press **[Shift]+[Display]** (System) to enter into the system menu interface.
2. Use left and right keys or rotate the knob to select **Comm** and press **[Enter]** key to confirm.
3. Use left and right keys or rotate the knob to select **RS485** and press **[Enter]** key to confirm.

```
RS485
9600_8_None_1
```

4. Rotate the knob to set the baud rate and press **[Enter]** key to confirm.
5. Use left and right keys or rotate the knob to select **RS485 Addr** and press **[Enter]** key to enter the RS485 address setting interface.
6. Rotate the knob to set the communication address and press **[Enter]** to confirm.
7. After finishing the setting, press **[Esc]** to exit.

3 Getting Started

- ◆ Power-on the Instrument
- ◆ Set the Output Voltage
- ◆ Set the Output Current
- ◆ Set the Output Power
- ◆ Use the Front Panel Menu
- ◆ Output On/Off Control

3.1 Power-on the Instrument

When you turn the POWER switch on for the first time after purchase, the instrument starts with its factory default settings. Each time thereafter, the instrument starts according to the setting that you selected as outlined in [4.2.2 Set the Power-on State](#).

Precautions

Before operation, please confirm that you have fully understood the safety instructions.

WARNING

- **Before connecting power cord, be sure to confirm that the power voltage matches with the supply voltage.**
- **Ensure that the input electrodes are either insulated or covered using the safety covers provided, so that no accidental contact with lethal voltages can occur.**
- **If you notice strange sounds, unusual odors, fire, or smoke around or from inside the instrument, flip the POWER switch to the (O) side to turn the instrument off, or remove the power cord plug from the outlet. The detachable power cord may be used as an emergency disconnecting device. Removing the power cord will disconnect AC input power to the unit.**

Power Switch Introduction

The power switch is located in the lower left corner of the front panel. The power switch is a button, and pressing once indicates ON and pressing again indicates OFF.

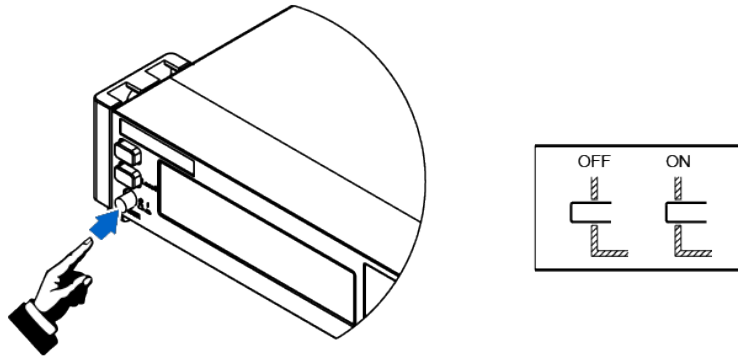

Turning the POWER Switch On

Check that the power cord is connected properly.

Flip the POWER switch to the (|) side to turn the instrument on. The front panel display will light up after a few seconds. It may take about 30 seconds or so for the power supply to initialize before it is ready for use.

If a self-test error occurs, an error message will be displayed in the front panel. Press the **[Esc]** button to try to clear the current fault status. The user can also restart the instrument to try to clear the fault status. Wait until the power is turned off and then start again. If the problem still cannot be solved after restarting, please contact the ITECH engineer. Common error messages are shown in the following table:

Error Messages	Description
Module Init Lost	The module information is lost.
Cal User Data Lose	User calibration information is lost.
Cal Factory Data Lose	Factory calibration information is lost.
Fan 1 Error!	Fan 1 is abnormal.
Fan 2 Error!	Fan 2 is abnormal
Chan Number Conflict	The channel number is conflict.
Ms Group Confcit	The master group is conflict.
Search Slave	The instrument is searching the slave.
Wait For Master	The instrument is waiting the master.
EEProm Failure	EEProm is broken.

Note

The instrument takes approximately 30 seconds to initialize before it is ready for use.

Turning the POWER Switch Off

Flip the POWER switch to the (O) side to turn the instrument off. When it is turned off, the instrument interface will prompt “Power Down”, and the instrument will store the setting information before shutdown in the group 1 non-volatile memory.

After you turn the POWER switch off, wait at least 10 seconds after the fan stops before you turn the POWER switch back on. Turning the instrument on too soon after you turn it off can cause damage to the inrush current limiter circuit, as well as reduce the life of components such as the POWER switch and the internal input fuses.

3.2 Set the Output Voltage

The voltage setting range is from 0 V to the maximum rated output voltage.

When **[V-set]** key is pressed, the key light is lit and the output voltage value can be set. Press right and left keys to move the cursor and rotate the knob to adjust the voltage value in voltage setting filed.

3.3 Set the Output Current

The current setting range is from 0 A to the maximum rated output current.

When **[I-set]** key is pressed, the key light is lit and the output current value can be set. Press right and left keys to move the cursor and rotate the knob to adjust the current value in current setting filed.

3.4 Set the Output Power

Power settings range from 0W to full rated output power. When the actual output power reaches the set value, the power supply enters the CP output mode. The setting method is as follows:

1. Press **[Shift]+[V-set]** (Config) to enter the configuration menu page.
2. Use the knob or press the left and right direction keys to select **P-Set**, press **[Enter]** to confirm, and enter the setting interface.

3. In the power setting area indicated by the cursor, press the left/right key to adjust the cursor position, and operate the knob to adjust the output power value.

3.5 Use the Front Panel Menu

The front panel command menu lets you access most of the instrument's functions. Briefly:

- Press the corresponding composite button to access the menu of the desired settings.
- Use the left and right arrow keys or knob to move through the menu. Each menu item is preceded by a number.
- Press **[Enter]** to change the current menu item to the state to be edited, or select a command and move to the next level in the menu. In addition, after changing the setting you need to press **[Enter]** to save.
- Press **[Esc]** to return to the previous menu. When performing any function key operation, press **[Esc]** key to exit the function operation state.

Please refer to [1.7 Front Panel Menu Reference](#) for the detailed map of the front panel menus.

3.6 Output On/Off Control

WARNING

- The [On/Off] key light is off and turning the output off does not place the instrument in a safe state. Hazardous voltages may be present on all output and guard terminals. Putting the equipment into an output-off state does not guarantee that the outputs are powered off if a hardware or software fault occurs. See the cautions about connecting the test lines before connecting test lines.
 - To prevent electrical shock that could cause injury or death, please ensure that the power supply and DUT have been connected well before you turn the output on.
 - If the power supply has no output after the output is turned on, please check whether the output lock interface Lock± of the power supply is shorted. Remove any jumper or shorting clip between Lock+ and Lock- to output normally. For details, please see [4.1.6 Output Lock Control](#).
 - The [On/Off] key is used to turn the output on or off under normal circumstances. Even if the instrument is in control by PC or the keyboard is locked, the [On/Off] is still valid.
-

You can turn the output of a single channel of the power supply on or off by pressing the [On/Off] key on the front panel. Press the [On/Off] key, the key light is on, indicating that the output of this channel is turned on, the VFD screen displays the voltage Meter value and the current Meter value, and the working state will switch to CC, CV or CP. Press the [On/Off] key again, the key light is off, indicating that the output of this channel is off, and the VFD screen shows that the power supply status is OFF.

You can turn the output of the two channels on or off simultaneously through the **ALL On/Off** on the front panel.

4 Functions and Features

This chapter describes in detail the functions and features of the instrument, including the following sections:

- ◆ Output Function
- ◆ System-Related Operations
- ◆ Multi-Machine Operation
- ◆ Channel Parallel Function (Parallel)
- ◆ Channel Series Function (Series)
- ◆ Protection Function
- ◆ List Function
- ◆ Single Channel External Analog Function (Option)
- ◆ Dual Channel External Analog Function (Option)

IT-M3100D series power supplies have the following three operating modes:

- Fixed mode: This is the default mode when the power supply is powered on. In fixed mode, the output parameters, protection function and such regular operations all can be set.
- List mode: Once enter the list function setting interface, the instrument automatically enters into the list mode. In list mode, the user can create a test program made of multiple steps. The setting parameters in list mode are only valid for list operation.

4.1 Output Function

WARNING

SHOCK HAZARD, LETHAL VOLTAGES Many models generate voltages greater than 600 VDC! Ensure that all instrument connections are either insulated or covered using the safety covers provided, so that no accidental contact with lethal voltages can occur.

4.1.1 Set the Output Priority Mode

- Voltage priority mode keeps the output voltage constant. In voltage priority mode, the output voltage should be set to the desired value. The output is controlled by a constant-voltage feedback loop, which maintains the output voltage at its programmed setting.

- Current priority mode keeps the output current constant. In current priority mode, the output current should be set to the desired value. The output is controlled by a constant-current feedback loop, which maintains the output current at its programmed setting.

The procedures to set the output priority mode are as follows.

1. Press **[Shift]+[V-set]**(Config) to enter into the configuration menu interface.
2. Use knob or left and right keys to select **Mode**, press **[Enter]** to confirm.
3. Select **CC Priority** or **CV Priority**, press **[Enter]** to enter into the setting interface.
 - Select **CV Priority**, the menu displays V-Rise Time and V-Fall Time.
 - Select **CC Priority**, the menu displays I-Rise Time and I-Fall Time.
4. Select the desired menu item, press **[Enter]** to confirm.
5. Use knob to adjust the values and press **[Enter]** to confirm.

4.1.2 Set the Output-On/Output-Off Delay Time

You can set the output-on/output-off delay time within the range from 0 seconds to 10 seconds. During the output delay time, the VFD displays  on the top right corner. Once the output-on delay timer expires, the VFD displays "CC" or "CV". Once the output-off delay timer expires, the VFD displays "OFF".

- On Delay is from the time that a command to turn on the output is received until the output actually turns on.
- Off Delay is from the time that a command to turn off the output is received until the output actually turns off.

The procedures to set the output delay time are as follows.

1. Press **[Shift]+[V-set]**(Config) to enter into the configuration menu interface.
2. Use knob or left and right keys to select **On Delay** or **Off Delay** and press **[Enter]** to confirm.
3. Use knob to adjust the output-on/output-off delay time and press **[Enter]** to confirm.

4.1.3 Set the Sense Function State

This menu item is used to switch the power supply to local sensing or remote sensing.

IT-M3100D series power supplies support two connection methods between power supply and device under test (DUT): Local sensing and Remote sensing. The remote sensing is used for maximizing measurement accuracy. (Refer to [2.6 Connecting the Device Under Test \(DUT\)](#) for more information.)

The procedures to set the menu item are as follows.

1. Press **[Shift]+[V-set]** (Config) to enter into the configuration menu interface.
2. Use left and right keys or rotate the knob to select **Sense** and press **[Enter]** key to make the parameter in modification.
3. Rotate the knob to select the value from the following options.
 - Off: default value, indicates turn the sense function off.
 - On: indicates turn the sense function on.
4. After finishing the setting, press **[Enter]** key to confirm.

4.1.4 Set the Bleeder State (Bleeder)

This menu item is used to set the status of the bleeder circuit (**Bleeder**). **On** and **Off** apply to the following test scenarios:

- On (default): For test scenarios other than battery charging tests. After the **Bleeder** is turned on, when the test is finished and the output is turned off, the voltage can be dropped quickly.
- Off: For battery charging test scenarios. Since some devices inside the instrument can absorb power, when the test is finished and the battery is still connected to the test circuit, these devices will still discharge the battery even if the output is turned off or the instrument is powered off. Therefore, before connecting the battery to the test circuit, set **Bleeder** to **Off** to disconnect the bleeder circuit to avoid this problem.



Note

Turning off the **Bleeder** can omit the diode which is used to prevent reverse current during battery testing.

The procedures to set the menu item are as follows.

1. Press **[Shift]+[V-set]** (Config) to enter into the configuration menu interface.
2. Use left and right keys or rotate the knob to select **Bleeder** and press **[Enter]** key to make the parameter in modification.
3. Rotate the knob to select **Off** or **On** and press **[Enter]** key to confirm.

4.1.5 Select Trigger Source(Trig Source)

This menu item is used to select the trigger source.

IT-M3100D series power supply supports the following trigger sources:

- Keypad: Select the front panel **[Shift]+[On/Off]** (Trigger) button as the trigger source;
- Bus: Select the remote interface command as the trigger source, such as the ***TRG** command;
- Ext: Select the rear panel trigger signal interface TRIG± (IN status) as the trigger source. Please refer to [4.2.4 Set the TRIG± Interface Status \(Ext IO\)](#) for detailed information about TRIG± interface status settings.

The procedures to set the menu item are as follows.

1. Press **[Shift]+[V-set]** (Config) to enter into the configuration menu interface.
2. Use left and right keys or rotate the knob to select **Trig Source** and press **[Enter]** key to make the parameter in modification.
3. Rotate the knob to adjust the parameter.
4. After setting, press **[Enter]** key to confirm.

4.1.6 Output Lock Control

The IT-M3100D series power supply rear panel provides an output lock interface Lock±. The user can disable the power output by shorting the Lock+ and Lock– interfaces to prevent the from mishandling the power supply during the test and causing damage to the DUT. The output can be re-enabled by removing the jumper or shorting clip between the Lock+ and Lock– connectors.

The figure below shows the short connection between the Lock± interfaces.

Lock output jumper.

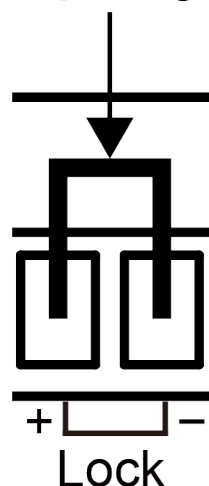

4.2 System-Related Operations

Though not directly related to output programming, the following functions also control instrument operation.

4.2.1 Set the Key Beeper

You can customize the on/off setting of the sound of the keys on the front panel of the instrument according to your needs.

The procedures to set the key beeper are as follows.

1. Press **[Shift]+[Display]** (System) to enter into the system menu interface.

The first displayed menu item **Beep** is to set the key beeper.

2. Press **[Enter]** key and the parameter is in modification.
3. Rotate the knob to adjust the value.
 - On: default value, indicates the key sound beeper is on.
 - Off: indicates the key sound beeper is off.
4. Press **[Enter]** key to confirm.

At this point, the key sound beeper status immediately becomes valid.

4.2.2 Set the Power-on State

This menu item is used to control the settings and output state when the power supply is powered on.

The detailed power-on parameters and output state are as follows.

- The voltage and current setting values displayed on the main screen.
- The output state of the power supply, i.e., the **[On/Off]** key state.

The procedures to set the menu item are as follows.

1. Press **[Shift]+[Display]** (System) to enter into the system menu interface.
2. Use left and right keys or rotate the knob to select **PowerOn** and press **[Enter]** key to make the parameter in modification.
3. Rotate the knob to select the value from the following options.
 - **Reset**: default value, indicates when the power supply is powered on, the power supply will initialize some settings and output state.

- **Last**: indicates when powered on, the power supply will remain the same settings and output state as last time you turned off the power supply.
 - **Last+Off**: indicates when powered on, the power supply will remain the same settings as last time you turned off the power supply, but the output state is OFF state.
4. After finishing the setting, press **[Enter]** key to confirm.

4.2.3 Set the Communication Information

This menu item is used to set the communication information between instrument and PC. There is no standard communication interfaces for this series power supplies. You can select GPIB, USB, RS-485, RS-232, CAN or LAN interface based on personal requirement.

The procedures to set the menu item are as follows.

1. Press **[Shift]+[Display]** (System) to enter into the system menu interface.
2. Use left and right keys or rotate the knob to select **Comm** and press **[Enter]** key to make the parameter in modification.

The menu displays the corresponding interface information automatically based on the inserted communication board.

3. Use left and right keys or rotate the knob to adjust the values.
4. After finishing the setting, press **[Enter]** key to confirm.



Note

Please refer to [2.7 Connect the Communication Interface](#) for the detailed description of each communication interface.

4.2.4 Set the TRIG± Interface Status (Ext IO)

The TRIG± interface is located on the rear panel of the instrument. For details, see [1.6 Rear-Panel Overview](#). The TRIG± interface allows a trigger signal to be applied to the instrument or a trigger signal from the instrument.

- Trig In: When the trigger source is set to **Ext**, inputting a high pulse trigger signal through TRIG± interface can trigger the instrument.
- Trig Out: When the trigger source is set to **Keypad** or **Bus** and the trigger happens, the TRIG± interface generates a high pulse trigger signal.

- On Sync Out: As the indication signal of the instrument output status. When the output is OFF, the pins output 0V low level; when the output is ON, the pins output 5V high level.
- On Sync In: Used to control the output state of the instrument. Input 0V low level to the pins, the instrument output is OFF; input 5V high level to the pins, the instrument output is ON.

The procedures to set the menu item are as follows.

1. Press **[Shift]+[Display]** (System) to enter into the system menu interface.
2. Use left and right keys or rotate the knob to select **Ext IO** and press **[Enter]** key to make the parameter in modification.
3. Rotate the knob to set and press **[Enter]** key to confirm.

4.2.5 Restore the Factory Default Settings

This menu item is used to restore the factory default settings.

The procedures to set the menu item are as follows.

1. Press **[Shift]+[Display]** (System) to enter into the system menu interface.
2. Use left and right keys or rotate the knob to select **System Reset** and press **[Enter]** key to make the parameter in modification.
3. Use left and right keys or rotate the knob to select the value from the following options.
 - No: default value, indicates the power supply cancels this menu setting.
 - Yes: indicates the power supply restores the factory default settings.
4. After finishing the setting, press **[Enter]** key to confirm.

The detailed default parameters are listed in the following table.

No.	Parameter	Default Value
The setting values on the front panel		
1	Voltage	0
2	Current	MAX
Config menu		
1	Mode	CV Priority
2	V-Rise Time	0.001 S
3	V-Fall Time	0.001 S
4	I-Rise Time	0.001 S

No.	Parameter	Default Value
5	I-Fall Time	0.001 S
6	On Delay	0.000 S
7	Off Delay	0.000 S
8	Sense	Off
9	Bleeder	On
System menu		
1	Beep	On
2	Power On	Reset
4	USB mode	TMC
5	IP Addr	192.168.200.100
6	Sub Net	255.255.255.0
7	Gateway	192.168.200.1
8	DNS1	192.168.200.1
9	DNS2	192.168.200.2
10	Socket Port	30000
11	RS232	9600_8_None_1
12	CAN Baud rate	250k
13	CAN Address	1
14	EXT-Program	Off
15	RS-485	9600_8_None_1
16	Parallel Mode	Single
17	Link Status	Offline
18	Link Mode	On/Off Only
19	Chan Number	1
21	Trig	Out
22	Trig Source	Keypad
Protect menu		
1	U Max Level	MAX
2	U Min Level	0.00 V

No.	Parameter	Default Value
3	OVP Mode	Off
4	OVP Level	MAX
5	OVP Delay	10.00 S
6	OCP Mode	Off
7	OCP Level	MAX
8	OCP Dealy	10.00 S
9	OPP Mode	Off
10	OPP Level	MAX
11	OPP Delay	10.00 S

4.2.6 View the System Information

This menu item is used to view the system information of the instrument.

The procedures to view the system information are as follows.

1. Press **[Shift]+[Display]** (System) to enter into the system menu interface.
2. Use left and right keys or rotate the knob to select **System Info** and press **[Enter]** key to make the parameter in modification.

The user can use left and right keys or knob to view the following system information.

System Info	View the system information.	
	Model	Display the instrument model.
	Version	Instrument version information.
	Main	Display the main firmware version.
	Comm	Display the communication board version.
	Sub1	Display the version of the control board for channel 1.
	Sub2	Display the version of the control board for channel 2.
	SN	Display the serial number.

	Last Cal	Display last calibration date.
--	----------	--------------------------------

4.2.7 Switch Local/Remote Mode

This series power supplies provide local operation and remote operation. The default mode is local operation mode.

- Local operation mode: use front panel keys to control the power supply.
- Remote operation mode: the power supply is connected to PC, the user uses the software in PC to control the power supply remotely.

During remote control operation, the remote symbol  is displayed at the top right corner of the front panel display. All panel keys, except the **[On/Off]** and **[Shift]+[Link]** (Local) keys, are locked.

You can press **[Shift]+[Link]** (Local) to switch the remote control to local control. The mode modification will not affect the output parameters.

4.2.8 Key Lock Function

The front panel controls can be locked to protect from accidental power supply parameter change. Press **[Shift]+[Enter]** (Lock) to lock front panel keys and the lock symbol  is shown on the front panel display. All panel keys, except the **[On/Off]** and **[Shift]+[Enter]** (Lock) keys, are locked. You can repress **[Shift]+[Enter]** (Lock) to unlock the front panel.

4.2.9 Save and Recall Operations

This series power supplies can save up to 10 common parameters in non-volatile memory (No. 1 to No. 10) for user to recall conveniently.



Note

The instrument provides a power-down save function. When the power is turned off, the setting information before shutdown is automatically stored in the first group of non-volatile memory.

The saved settings include the following parameters.

- The voltage setting value;
- The current setting value.

You can do the save and recall operations by the following two methods.

- Front panel keys: **[Shift]+[Left]** (Save) and **[Shift]+[Right]** (Recall) ;
- SCPI command: *SAV and *RCL.

Save Operations

1. Press **[Shift]+[Left]** (Save) to enter into the saving interface.
2. Set the storage location.
Use knob to adjust a value from 1 to 10 on the prompt interface "Save File = 1" to set the storage location in non-volatile memory.
3. Press **[Enter]** key to confirm.

Recall Operations

You can recall the parameters you saved in the specified memory location as the setting values.

1. Press **[Shift]+[Right]** (Recall) to enter into the saving interface.
2. Set the recall location.
Use knob to adjust a value from 1 to 10 on the prompt interface "Recall File = 1" to set the recall location in non-volatile memory.

The second lines displays the stored voltage and current values in the specified memory location

3. Press **[Enter]** key to confirm the recall operation.

4.3 Multi-Machine Operation

WARNING

SHOCK HAZARD All paralleled units must be connected to ground through a grounded power cord at all times. Any interruption of the protective (grounding) conductor or disconnection of the protective earth terminal on any unit will cause a potential shock hazard that could result in injury or death.

Function Introduction

The multi-machine operation refers to connecting multiple instruments according to a fixed wiring mode through the System Bus interface to realize multi-channel and synchronous control functions.

Type	Introduction	Maximum Quantity	Model Restriction	Communication Object
Multi-channel	Only can be used in the PC software (IT9000). By communicating one unit in the System Bus link with the PC, it is possible to independently control any other unit in the PC software.	A maximum of 8 units can be connected in each System Bus link.	Multi-channel systems can be composed of single units of the same series and different models.	Any unit in each System Bus link
Synchronization	By operating one unit in the System Bus link locally or remotely, it is possible to synchronously control the On/Off and equal-scale output of the other units.	A maximum of 8 units can be connected in each System Bus link.	Synchronization systems can be composed of single units of the same series and different models.	Any unit in each System Bus link

4.3.1 Multi-Channel Function

When multiple power supplies are connected through the System Bus, an independent channel number should be set for CH1 of each power supply, and the setting items are 1, 3, 5, 7, 9, 11, 13, and 15. The Channel number of CH2 of the same power supply will automatically increase by 1 according to the setting of CH1. The power supply connected to the same system bus, the channel number can not be repeated, otherwise it will cause conflicts. All power interfaces will prompt "Chan Number Conflict". In this case, rotate the knob to change the channel number directly, press **[Enter]** to confirm.

After forming a multi-channel power system, the channel number is displayed on each instrument interface. Connect the communication interface of one of the power supplies to the PC, then the user can independently control each power supply of the system in the PC software. The following three power supplies are taken as an example to describe the connection and operation steps of multiple channels.

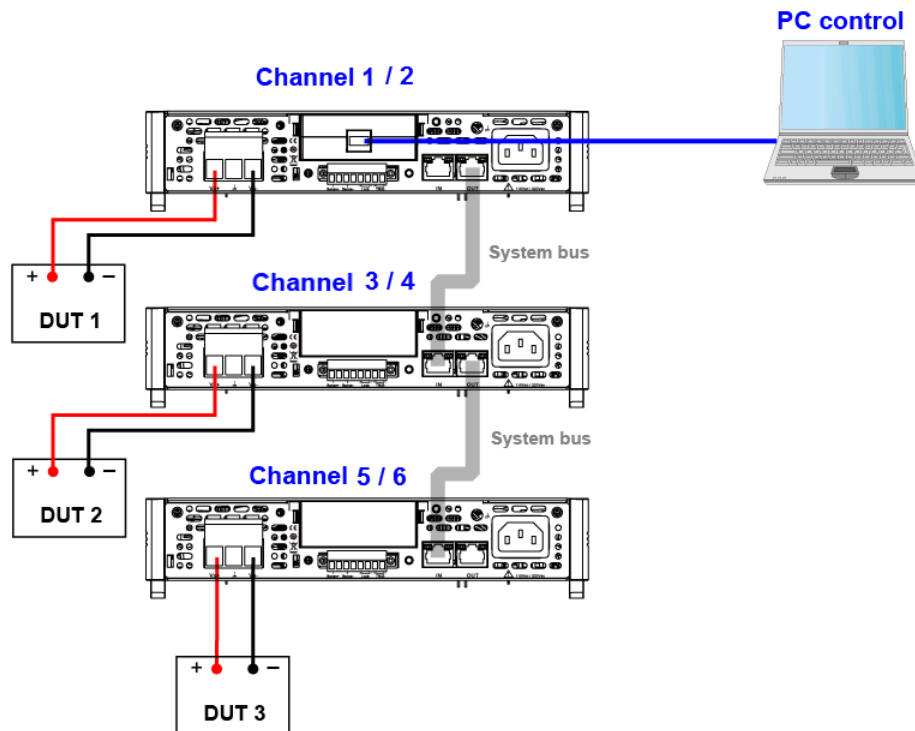

Note

The rear panel shown in the figure is only an example. The actual appearance of the rear panel is subject to the specific instrument.

The procedures to set the channel number are as follows.

1. Set the channel number for each instrument.
 - a. Press **[Shift]+[Display]** (System) to enter into the system menu interface.
 - b. Use left and right keys or rotate the knob to select **Chan Number** and press **[Enter]** key to make the parameter in modification.
 - c. Rotate the knob to adjust the value and set the channel number. Press **[Enter]**.
 - d. Repeat steps a through c to set the channel number for other power supplies.
2. Connect the instruments according to the above diagram. Please disconnect the power before wiring.
 - a. Connect system bus interfaces.
 - b. Connect the DUTs. Refer to [2.6 Connecting the Device Under Test \(DUT\)](#) for more information about connection methods.
 - c. Connect the power supply to PC.

3. After power-on, if the interface prompts “Chan Number Conflict”, rotate the knob to change the channel number directly.

4.3.2 Synchronized Function (Link)

The user can set synchronized operation mode among multiple power supplies connected via the system bus. There are the following two synchronized status.

- **Online:** indicates the instrument is in the synchronized relationship. At this time, the front panel **[Link]** key light is lit.
- **Offline:** indicates the instrument is not in the synchronized relationship and the front panel **[Link]** key light is off.

The user can select the following three synchronized modes.

- **On/Off Only:** set multiple units to output on/off and Save/Recall synchronization.



Note

When the Save/Recall operation is performed, the **[Link]** light of the operating device will be on, and the **[Link]** lights of other devices will be off.

- **Track:** besides output on/off and Save/Recall synchronization, you can set the voltage proportional relation **Reference** among multiple power supplies to make the voltage change proportionally. For example, set the voltage proportional relation for three power supplies to 3, 4 and 5. If the voltage of the first power supply is set to 30 V, the voltage of the other two power supplies will change to 40 V and 50 V automatically.



Note

In the **Track** mode, the Save/Recall synchronization is only effective for the current setting value, and the voltage setting value is controlled by the **Reference**.

- **Duplicate:** in this mode, the synchronized operations includes: output on/off synchronization, voltage/current setting value changing synchronization, Save/Recall synchronization, priority mode synchronization, voltage/current rising/falling synchronization and Protect menu function synchronization.

CAUTION

Only models of the same type can be configured in Duplicate mode.

Note

For multiple devices that have formed a synchronization relationship, after the mode is set to **Duplicate**, long press (about 3 s) the **Link** button of any device to quickly synchronize the voltage/current setting value, priority mode, voltage/current rise/fall value, and Protect settings to other devices.

Setting method:

You can enter into the system menu to set the status(Online/Offline) of the instrument, or you can short press (1 s or so) the front panel **[Link]** key to switch the synchronization status of the instrument. Long pressing (about 3 s) **[Link]** key can display the current synchronization status of the instrument. At this time, pressing **[Enter]** key can enter into the synchronization menu setting interface. You can set parameters such as synchronized mode or On/Off delay time.

Note

In the synchronized status, you can set the On/Off delay time of each instrument to customize your test timing.

Take the synchronized relationship among single power supply and multiple parallel groups for instance, the detailed connection method and procedures are as follows.

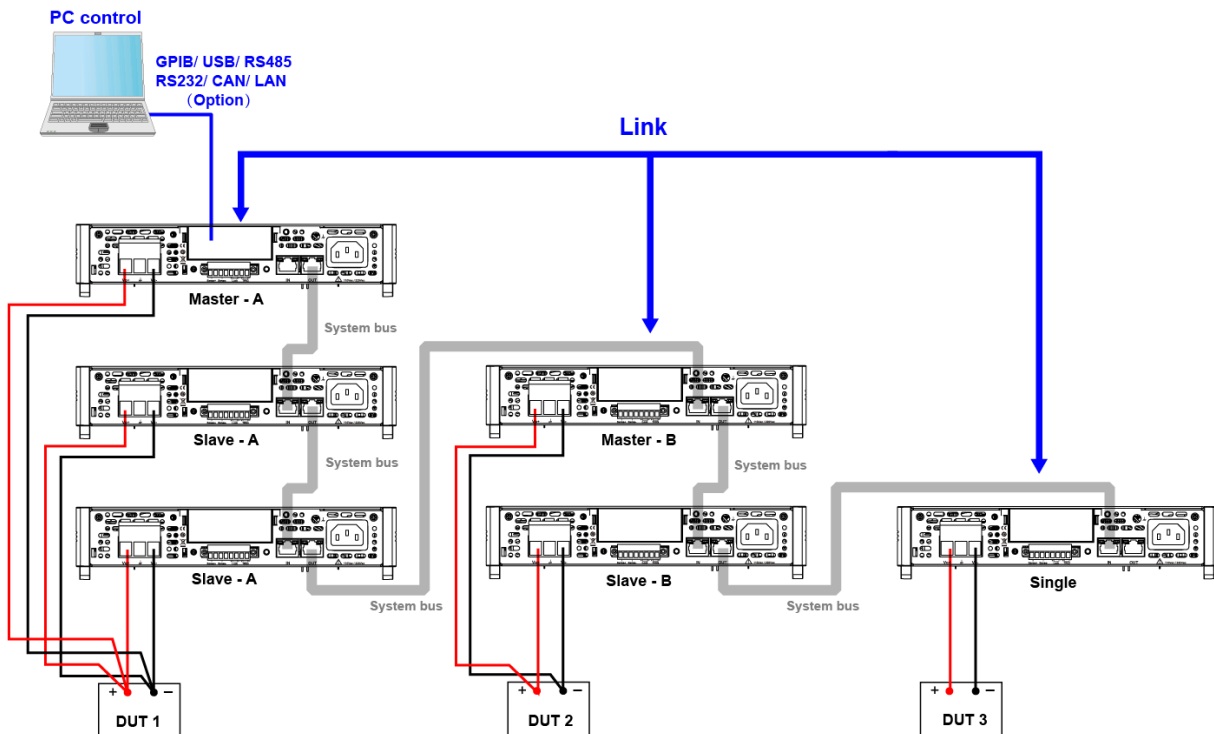

Note

The rear panel shown in the figure is only an example. The actual appearance of the rear panel is subject to the specific instrument.

1. Configure the channel number of each instrument. Please refer to [4.3.1 Multi-Channel Function](#) for detailed introduction.
2. Connect the instruments according to the above diagram.
 - a. Connect system bus interfaces.
 - b. Connect the DUTs. Refer to [2.6 Connecting the Device Under Test \(DUT\)](#) for more information about connection methods.
3. Turn on the **Link** switch of each instrument in turns.
 - a. Press **[Shift]+[Display]** (System) to enter into the system menu interface.
 - b. Use left and right keys or rotate the knob to select **Link** and press **[Enter]** key to make the parameter in modification.
 - c. Rotate the knob to set **Status** and press **[Enter]** key to confirm.
 - **Online**: indicates the instrument is in the synchronized relationship.
 - **Offline**: indicates the instrument is not in the synchronized relationship.
4. Operate the front panel of one unit in the System Bus link and set the synchronization mode (other units modes will be modified simultaneously).
 - a. Press **[Shift]+[Display]** (System) to enter into the system menu interface.
 - b. Use left and right keys or rotate the knob to select **Link** and press **[Enter]** key to make the parameter in modification.
 - c. Rotate the knob to set **Mode** and press **[Enter]** key to confirm.
 - **OnOff Only**
 - **Track→Reference**

Note

If you select **Track** mode, you need to set the **Reference** value of each unit in the System Bus link.

- **Duplicate**

4.4 Channel Parallel Function (Parallel)

Parallel in the System menu supports connect the two channels of a single IT-M3100D in parallel, the upper limit of the current setting range is twice the rated value of the single channel, and the instrument is used as a single channel power supply at this time.

Parallel configuration of 2 or more IT-M3100Ds is not supported.

After parallel combination, it is operated as a single instrument. The initial settings of each function menu and voltage, current and power are based on the following rules:

- **Config menu:** After Parallel, the CC/CV priority, on/off delay, Sense switch, and trigger mode in the Config menu refer to the settings of CH1, and the rise/fall time in the Config menu refers to the slowest slope setting of the two channels. After switching back to single, both channels refer to Parallel settings.
- **Voltage/Current/Power setting:** After Parallel, V-set is the smaller value of the two-channel voltage. I-set is the sum of the current settings of the two channels. P-set is twice the power set value of CH1. When switching back to single, the current and power setting values of the two channels are half of the corresponding setting of Parallel, and the voltage is the corresponding voltage in Parallel mode.
- **PROTECT menu:** After Parallel, the default is the parameters of CH1 channel. When switching back to single, the two channels are Parallel parameters.



Note

- **OPP:** After Parallel, the setting value is the sum of the OPP setting values of the two channels. When switching back to single, it is half of Parallel OPP.
- **OCP:** After Parallel, OCP defaults to the sum of the OCP current settings of the two channels. When switching back to single, the OCP of the two channels is half of Parallel.
- **Foldback protection:** When the Foldback settings of the two channels are the same, after combining, the default is the setting of CH1. When the Foldback settings of the two channels are different, the Foldback will be turned off after Parallel. When switching back to single, the settings of the two channels are the same as those of Parallel.
- **Save/Recall:** When it is Single, after the two channels execute save and Parallel respectively, the recall voltage value is the CH1 voltage value, and the current is the sum of the current values of the two channels. When it is

Parallel, execute save and restore Single, the Recall voltage value of the two channels is the Parallel voltage value, and the current is half of the Parallel mode.

The detailed connection method and operation steps are as follows.

1. Set the two channels of the power supply to Parallel mode.
 - a. Press the **[Shift]+[Display]** (System) key to enter the system menu.
 - b. Press the left and right direction keys or rotate the knob, select “Connect”, and press **[Enter]** to enter the edit mode.
 - c. Rotate the knob to select “Parallel” and press **[Enter]** to confirm.
2. After the parameter setting is completed, the instrument will restart automatically. After restarting, the device will enter the 2-channel parallel combination mode.
3. Refer to the figure below to connect the DUT, and live wiring is prohibited.

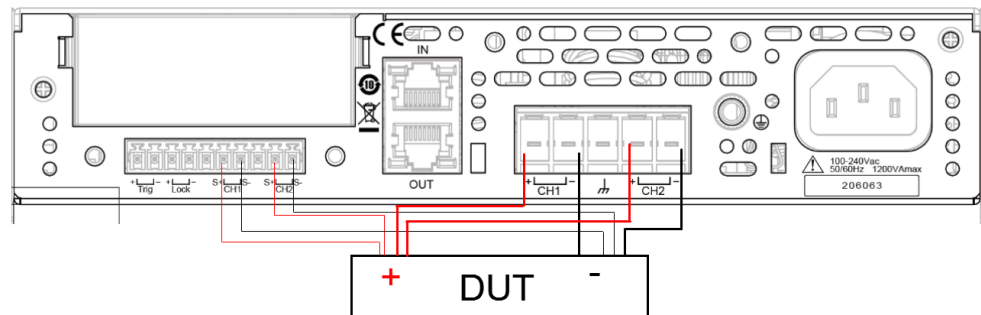

Note

The connection method shown in the figure above is the wiring method when the Sense is turned on, that is, the Sense terminals of the two channels are respectively connected to the DUT.

If you want to change the parallel combination mode to the single mode, perform the following steps:

1. Switch the instrument to Single mode.
 - a. Press the **[Shift]+[Display]** (System) key to enter the system menu.
 - b. Press the left and right direction keys or rotate the knob, select “Connect”, and press **[Enter]** to enter the edit mode.
 - c. Rotate the knob, select **Single**, and press **[Enter]** to confirm.
2. After the parameter setting is completed, the instrument will restart automatically. After restarting, the device will enter the 2-channel independent mode.

3. Refer to the figure below to connect the DUT, and live wiring is prohibited.

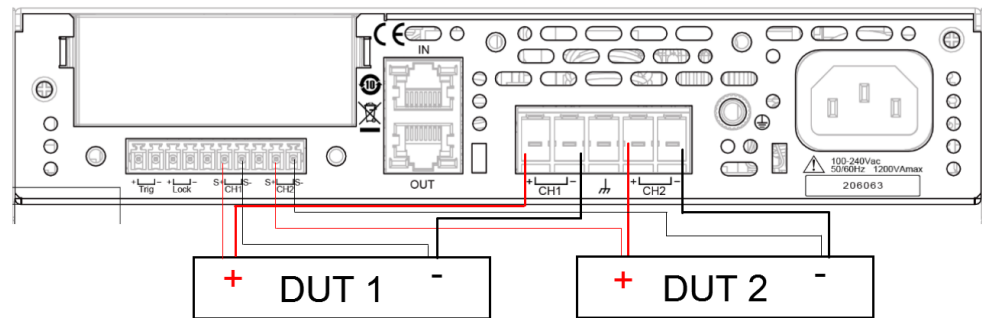

Note

The connection method shown in the figure above is the wiring method when both channels of Sense are turned on.

4.5 Channel Series Function (Series)

Series in the System menu supports connect the two channels of a single IT-M3100D in Series, the upper limit of the voltage setting range is twice the rated value of the single channel (**and no more than 100V**), and the instrument is used as a single channel power supply at this time.

Series configuration of 2 or more IT-M3100Ds is not supported.

After Series combination, it is operated as a single instrument. The initial settings of each function menu and voltage, current and power are based on the following rules:

- **Config menu:** After Series, the CC/CV priority, on/off delay, Sense switch, and trigger mode in the Config menu refer to the settings of CH1, and the rise/fall time in the Config menu refers to the slowest slope setting of the two channels. After switching back to single, both channels refer to Series settings.
- **Voltage/Current/Power setting:** After Series, I-set is the smaller value of the two-channel current. V-set is the sum of the voltage settings of the two channels (**and no more than 100V**). P-set is twice the power set value of CH1. When switching back to single, the voltage and power setting values of the two channels are half of the corresponding setting of Series, and the current is the corresponding current in Series mode.
- **PROTECT menu:** After Series, the default is the parameters of CH1 channel. When switching back to single, the two channels are Series parameters.

Note

- OPP: After Series, the setting value is the sum of the OPP setting values of the two channels. When switching back to single, it is half of Series OPP.
- OVP: After Series, OVP defaults to the sum of the OVP voltage settings of the two channels. When switching back to single, the OVP of the two channels is half of Series.
- **Foldback protection:** When the Foldback settings of the two channels are the same, after series, the default is the setting of CH1. When the Foldback settings of the two channels are different, the Foldback will be turned off after Series. When switching back to single, the settings of the two channels are the same as those of Series.
- **Save/Recall:** When it is Single, after the two channels execute save and Series respectively, the recall current value is the CH1 current value, and the voltage is the sum of the voltage values of the two channels (**and no more than 100V**). When it is Series, execute save and restore Single, the Recall current value of the two channels is the Series current value, and the voltage is half of the Series mode.

The detailed connection method and operation steps are as follows.

1. Set the two channels of the power supply to Series mode.
 - a. Press the **[Shift]+[Display]** (System) key to enter the system menu.
 - b. Press the left and right direction keys or rotate the knob, select “Connect”, and press **[Enter]** to enter the edit mode.
 - c. Rotate the knob to select “Series” and press **[Enter]** to confirm.
2. After the parameter setting is completed, the instrument will restart automatically. After restarting, the device will enter the 2-channel Series combination mode.
3. Refer to the figure below to connect the DUT, and live wiring is prohibited.

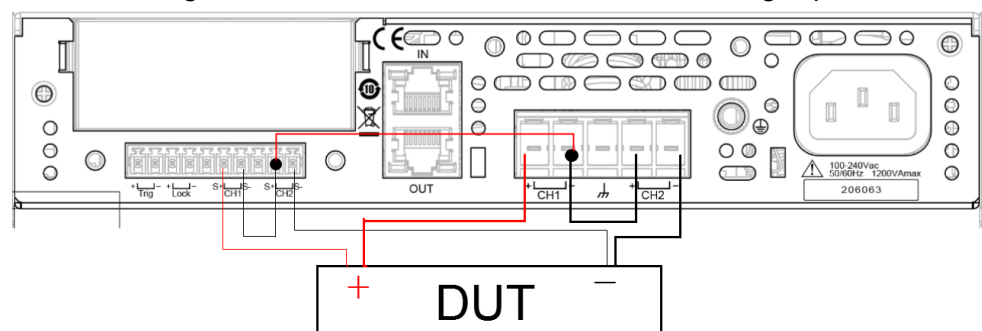

Note

The connection method shown in the figure above is the wiring method when the Sense is turned on.

If you want to change the Series combination mode to the single mode, perform the following steps:

1. Switch the instrument to Single mode.
 - a. Press the **[Shift]+[Display]** (System) key to enter the system menu.
 - b. Press the left and right direction keys or rotate the knob, select “Connect”, and press **[Enter]** to enter the edit mode.
 - c. Rotate the knob, select **Single**, and press **[Enter]** to confirm.
2. After the parameter setting is completed, the instrument will restart automatically. After restarting, the device will enter the 2-channel independent mode.
3. Refer to the figure below to connect the DUT, and live wiring is prohibited.

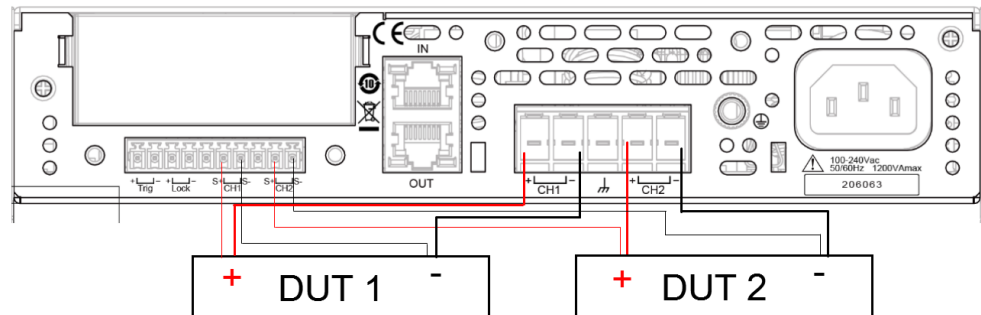

Note

The connection method shown in the figure above is the wiring method when both channels of Sense are turned on.

4.6 Protection Function

This series power supplies provide the following protection functions. You can set these functions in the Protect menu.

- The maximum output setting value (U-Max), the minimum output voltage setting value (U-Min), these functions limit the setting value of the output voltage from front panel.
- Over-voltage protection, over-current protection, over-power protection, and over-temperature protection, these functions disable the output to protect the device under test (DUT), as well as the power supply.

4.6.1 Set the Setting Value Limit Protection

To avoid causing damage to the DUT, after you set the U-Max, U-Min, the setting value from the **[V-set]** key on the front panel can't exceed the setting limit.

The operation steps are as follows.

1. Press **[Shift]+[Esc]** (Protect) to enter Protect menu interface.
2. Use left and right keys or rotate the knob to select **U-Max**, **U-Min**, and press **[Enter]** key to confirm.
3. Rotate the knob to adjust the value and press **[Enter]** key to confirm.
4. Press **[Esc]** to exit the protection menu setting.

4.6.2 Set Over-Voltage Protection

Over-voltage protection function allows the user to enable the protection and set a over-voltage limit (**Level**) and delay time (**Delay**). This function prevents the output voltage from being higher than the limited output voltage and protects the connected DUT so it this is not over-voltage and possibly damaged due to an excessive voltage.

An over-voltage protection will occur if:

- Enable OVP;
- The output voltage value is greater than the set voltage protection point **Level** and the period is greater than the set protection delay time **Delay**.

Delay time **Delay** — You can specify an OVP delay to prevent momentary output settings, DUT and status changes from tripping the over-voltage protection. In most cases these momentary conditions would not be considered an over-voltage protection fault, and having an OVP condition disable the output when they occur would be a nuisance. Specifying an OVP delay lets the OVP circuit ignore these momentary changes during the specified delay period. Once the OVP delay time has expired and the over-voltage condition persists, the output will shut down.

When over-voltage protection occurs, the instrument responds as follows:

- Instrument output is off;
- The buzzer sounds;
- The interface displays “Over Voltage Protect” and flashes;
- Status register, the OV status bit is set to 1.

Enable OVP

1. Press **[Shift]+[Esc]** (Protect) to enter Protect menu interface.
2. Use left and right keys or rotate the knob to select **OVP** and press **[Enter]** key to confirm.
3. Use left and right keys or rotate the knob to select **On** and press **[Enter]** key to confirm.
4. Rotate the knob to adjust the over-voltage limit **Level** and press **[Enter]** key to confirm.

5. Rotate the knob to adjust the delay time **Delay** and press **[Enter]** key to confirm.
6. Press **[Esc]** to exit the protection menu setting.

Clear Over-Voltage Protection

To clear the over-voltage and return to normal operation, firstly remove the conditions that caused the protection fault. Press **[Esc]** key (or send the command **PROtection:CLEar**) to clear the protection status. The “Over Voltage Protect” displayed in front panel is cleared and the instrument exits OVP status.

4.6.3 Set Over-Current Protection

Over-current protection function allows the user to enable the protection and set a over-current limit (**Level**) and delay time (**Delay**). This function prevents the output current from being higher than the limited output current and protects the connected DUT so it this is not over-current and possibly damaged due to an excessive current.

An over-current protection will occur if:

- Enable OCP;
- The output current value is greater than the set current protection point **Level** and the period is greater than the set protection delay time **Delay**.

Delay time **Delay** — You can specify an OCP delay to prevent momentary output settings, DUT and status changes from tripping the over-current protection. In most cases these momentary conditions would not be considered an over-current protection fault, and having an OCP condition disable the output when they occur would be a nuisance. Specifying an OCP delay lets the OCP circuit ignore these momentary changes during the specified delay period. Once the OCP delay time has expired and the over-current condition persists, the output will shut down.

When over-current protection occurs, the instrument responds as follows:

- Instrument output is off;
- The buzzer sounds intermittently;
- The interface displays “Over Current Protect” and flashes;
- Status register, the OC status bit is set to 1.

Enable OCP

1. Press **[Shift]+[Esc]** (Protect) to enter Protect menu interface.

2. Use left and right keys or rotate the knob to select **OCP** and press **[Enter]** key to confirm.
3. Use left and right keys or rotate the knob to select **On** and press **[Enter]** key to confirm.
4. Rotate the knob to adjust the over-current limit **Level** and press **[Enter]** key to confirm.
5. Rotate the knob to adjust the delay time **Delay** and press **[Enter]** key to confirm.
6. Press **[Esc]** to exit the protection menu setting.

Clear Over-Current Protection

To clear the over-current and return to normal operation, firstly remove the conditions that caused the protection fault. Press **[Esc]** key (or send the command **PROtection:CLEar**) to clear the protection status. The “Over Current Protect” displayed in front panel is cleared and the instrument exits OCP status.

4.6.4 Set Over-Power Protection

Over-power protection function allows the user to enable the protection and set a over-power limit (**Level**) and delay time (**Delay**). This function prevents the output power from being higher than the limited output power and protects the connected DUT so it this is not over-power and possibly damaged due to an excessive power.

An over-power protection will occur if:

- Enable OPP;
- The output power value is greater than the set power protection point **Level** and the period is greater than the set protection delay time **Delay**.

Delay time **Delay** — You can specify an OPP delay to prevent momentary output settings, DUT and status changes from tripping the over-power protection. In most cases these momentary conditions would not be considered an over-power protection fault, and having an OPP condition disable the output when they occur would be a nuisance. Specifying an OPP delay lets the OPP circuit ignore these momentary changes during the specified delay period. Once the OPP delay time has expired and the over-power condition persists, the output will shut down.

When over-power protection occurs, the instrument responds as follows:

- Instrument output is off;
- The buzzer sounds intermittently;
- The interface displays “Over Power Protect” and flashes;

- Status register, the OP status bit is set to 1.

Enable OPP

1. Press **[Shift]+[Esc]** (Protect) to enter Protect menu interface.
2. Use left and right keys or rotate the knob to select **OPP** and press **[Enter]** key to confirm.
3. Use left and right keys or rotate the knob to select **On** and press **[Enter]** key to confirm.
4. Rotate the knob to adjust the over-power limit **Level** and press **[Enter]** key to confirm.
5. Rotate the knob to adjust the delay time **Delay** and press **[Enter]** key to confirm.
6. Press **[Esc]** to exit the protection menu setting.

Clear Over-Power Protection

To clear the over-power and return to normal operation, firstly remove the conditions that caused the protection fault. Press **[Esc]** key (or send the command **PROtection:CLEar**) to clear the protection status. The “Over Power Protect” displayed in front panel is cleared and the instrument exits OPP status.

4.6.5 Over-Temperature Protection

To prevent damaging heat build-up and ensure specified performance, make sure there is adequate ventilation and air flow around the instrument to ensure proper cooling. Do not cover the ventilation holes on the top, sides, or bottom of the instrument.

Even with proper ventilation, the instrument can overheat in the following situations

- If the ambient temperature is too high;
- If you use the instrument to test for long periods.

Over-temperature protection is a protective measure implemented when the internal temperature of the instrument exceeds 90 degrees. Once the over-temperature protection has been triggered, the output will shut down and VFD shows “Over Temp Prot”.

If an over-temperature condition occurs, turn off the instrument and allow it to cool for 30 minutes. You cannot turn the output on until the instrument cools down. Press **[On/Off]** key to turn the output on.

CAUTION

When you return power to the instrument, verify that the cooling fan is running. If not, please contact ITECH. Leaving the instrument turned on with the failure message displayed or with an in-operative cooling fan may result in damage to the instrument.

4.6.6 Set foldback protection

This series of instruments has a Foldback protection function, which is used to turn off the output when the power supply CV / CC is switched, so as to protect certain DUTs that are sensitive to voltage overshoot and current overshoot. Foldback protection allows the user to specify a working mode and set the protection delay time. If the current working mode is switched, the protection will be triggered from the working loop switch. When the delay time is exhausted, the protection will be triggered and the output will be turned off.

- Enable FOLDBACK function;
- The loop is switched to the set working mode and the duration is greater than the set protection delay time;

Enable FOLDBACK function

1. Press **[Shift]+[Esc]** (Protect) to enter Protect menu interface.
2. Use left and right keys or rotate the knob to select **FOLDBACK** and press **[Enter]** key to confirm.
3. Select **CC** or **CV** and press **[Enter]** key to confirm.
 - Selecting CC means that the instrument triggers protection when the operating mode of the instrument switches to CC mode.
 - Selecting CV means that the instrument triggers protection when the operating mode of the instrument is switched to CV mode.
 - Select OFF to turn off the foldback function.
4. Rotate the knob to adjust the **Delay** and press **[Enter]** key to confirm.
5. Press **[Esc]** to exit the protection menu setting.

Delay FOLDBACK

You can specify a time for the FOLDBACK delay, which can make the instrument ignore the instantaneous change of the operating mode in the specified delay interval. In most cases, this instantaneous situation is not considered as a switching state, and there is no need to trigger the foldback function and disable Output. Once the FOLDBACK delay time is exceeded, the output is turned off.

4.7 List Function

The user can use list function to create a test program made of multiple steps. Up to 10 programs (List1 to List10) can be created in the list mode for this series power supplies. Each list program can be made of up to 100 steps. The user need to set voltage or current, slope and dwell time for each step. The user also can set repeat times, end state and so on for each list program.

WARNING

In the channel combination mode Combine, the List function is unavailable.

The descriptions of list function menu are listed in the table below.

List Mode	List mode			
	Run List	Turn the list mode on/off.		
		On	Turn the list mode on.	
		Off	Turn the list mode off.	
	Apply Channel	Select channel as CH1 or CH2		
	Recall List	Select a list program to view.		
		List Setup	View the setting parameters of the selected list program.	
		View Step	Select the desired step to view.	
	Edit List	Edit list program.		
		List Setup	Set the list program.	
			Mode	Set the operation mode for list program. <ul style="list-style-type: none"> • CC: current mode; • CV: voltage mode.
			End State	Set the running state after the list program is running over. <ul style="list-style-type: none"> • Normal: keep outputting the voltage and current setting in main interface when the dwell time is over. • Last: keep outputting the last step when the dwell time is over.
			Repeat	Set the number of loops to run the List file, range: 1–65535. Set to 65535 to run in an infinite loop.
	Edit Step	Edit parameters for each step.		

			Current/ Voltage	Current value or voltage value. (The voltage appears when CV mode is selected; the current appears when CC mode is selected.)
			Slope	Slope value (0.001~3600), unit: second.
			Time	Duration (0.001~3600), unit: second.
			Next	Select whether to edit the next step: <ul style="list-style-type: none"> • Yes • No
		Insert Step	Insert steps before each specified step.	
		Add Step	Add steps after each specified step.	
		Delete Step	Delete the selected step.	
		Delete all	Delete all steps.	
		Copy File X to X	Copy list program.	

4.7.1 Edit List Program

You can use the list program to perform a variety of output waveform simulations. The execution flowchart of list program is as follows.

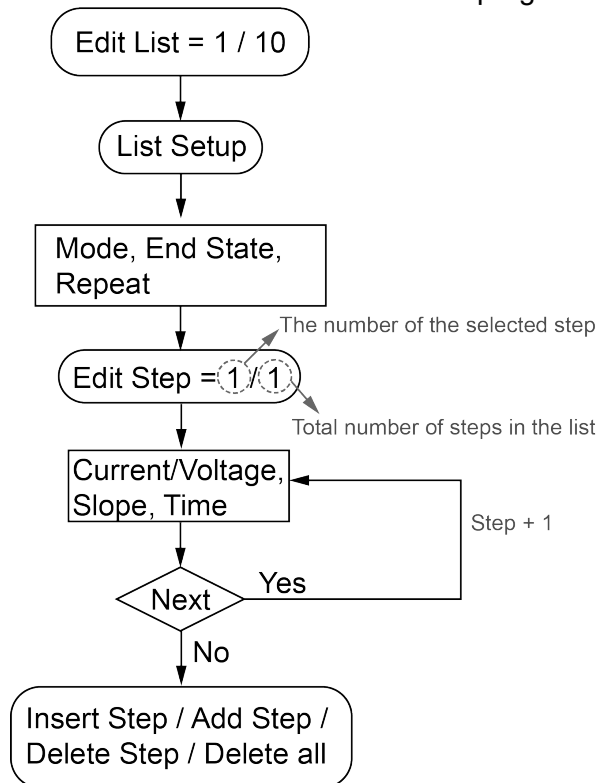

The detailed operation steps are as follows.

1. Press **[Shift]+[I-set]** (Function) to enter function menu interface.
2. Use left and right keys or rotate the knob to select **List** and press **[Enter]** key to confirm.
3. Use left and right keys or rotate the knob to select **Edit List** and press **[Enter]** key to confirm.
4. Use knob to set the list name and press **[Enter]** key to confirm.
5. Use left and right keys or rotate the knob to select **List Setup** and press **[Enter]** key to confirm.
 - a. Select **Mode** to set list mode: CC/ CV.
 - b. Select **End State** to set running state after the list program is running over.
 - Normal: keep outputting the voltage and current setting in main interface when the dwell time is over.
 - Last: keep outputting the last step when the dwell time is over.
 - c. Select **Repeat** to set the number of list repetitions.
6. Select **Edit Step** and press **[Enter]** key to confirm.
7. Use knob to set the desired list step number and press **[Enter]** key to confirm.

To the left of the slash is the desired step number to be edited and to the right of the slash is the total steps number of the list program. The total number of steps changes by the addition of the number of steps in the editing process.

- a. Select **Current** or **Voltage** to set the current or voltage value.
 - b. Select **Slope** to set the slope of the step.
 - c. Select **Time** to set the dwell time of the step.
 - d. Select **Next** to set whether to edit the next step. If set to **Yes**, repeat steps a through c to set the parameters for next step. If set to **No**, the list step parameters setting is over.
8. If you need to continue to adjust the list step, you can use the following settings to insert, add or delete steps.
 - If you need to insert steps, select **Insert Step** and press **[Enter]** key to confirm. Use knob to set the insert location and press **[Enter]** key. Repeat steps 7a through 7d to set the parameters for the inserted step. The inserted step is before each specified step and you can insert multiple steps continuously.
 - If you need to add steps, select **Add Step** and press **[Enter]** key to confirm. Use knob to set the add location and press **[Enter]** key. Repeat steps 7a through 7d to set the parameters for the added step. The added step is after each specified step and you can add multiple steps continuously.
 - If you need to delete steps, select **Delete Step** and press **[Enter]** key to confirm. Use knob to set the delete location and press **[Enter]** key.

- If you need to delete all steps, select **Delete all** and press **[Enter]** key to confirm. Use knob to select **Yes** and press **[Enter]** key.

4.7.2 Copy List Program

For an existed list program, you can copy and name it a new list program. Then you can edit the new list program, insert steps or delete steps. This function simplifies the edit operation for similar list program. The operation steps are as follows.

1. Press **[Shift]+[I-set]** (Function) to enter function menu interface.
2. Use left and right keys or rotate the knob to select **List** and press **[Enter]** key to confirm.
3. Use left and right keys or rotate the knob to select **Edit List** and press **[Enter]** key to confirm.
4. Use knob to set the list program name and press **[Enter]** key to confirm.
5. Select **Copy File X to X** and press **[Enter]** key to confirm.
6. Use knob to select setting source List program name and target List program name and press **[Enter]** key to confirm.

4.7.3 View List Program

Before selecting and running the list program, you can view the related parameters and each step of the existed list program. The operation steps to view the list program are as follows.

1. Press **[Shift]+[I-set]** (Function) to enter function menu interface.
2. Use left and right keys or rotate the knob to select **List** and press **[Enter]** key to confirm.
3. Use left and right keys or rotate the knob to select **Recall List** and press **[Enter]** key to confirm.
4. Use knob to select the list program to view and press **[Enter]** key to confirm.
5. Select **List Setup** and press **[Enter]** key to enter the view page of list file. Use left and right keys or rotate the knob to view the following parameters.
 - Mode: the operation mode for list program.
 - End State: the running state after the list program is running over.
 - Repeat: the number of list repetitions.
6. Select **View Step** and press **[Enter]** key to confirm.
7. Use knob to select the list step to view and press **[Enter]** key to confirm.

To the left of the slash is the desired step number to view and to the right of the slash is the total steps number of the list program. At this point, the interface displays all steps and automatically locates at the selected step.

8. Use knob or left and right keys to view all steps.

4.7.4 Run List Program

The user can run the existed list program as needed to enable outputting of corresponding waveform sequence by the power supply. Detailed operation steps are as below:

1. Press **[Shift]+[I-set]** (Function) to enter function menu interface.
2. Use left and right keys or rotate the knob to select **List** and press **[Enter]** key to enter the set interface of list mode.
3. Select the desired list program.
 - Method 1: Select **Recall List** and press **[Enter]** key. Use knob to select the desired list program and press **[Enter]** key to confirm.
 - Method 2: To simplify the operation, you can directly run the list program after editing it in the **Edit List** menu item. Skip the step in the **Recall List** menu item.
4. Select **Run List** and press **[Enter]** key to confirm.
5. Use the knob to set **Run List** to **On** and press **[Enter]** key to confirm.
6. Press **[On/Off]** key to turn the output on.
7. Based on the trigger method, perform the trigger operation. When the trigger signal is received, the power supply outputs the waveform sequences.

Stop running: During the running of List, you can press **[Shift]+[I-set]** (Function) to enter the Function menu and set the **Run List** as **Off** to stop running. Otherwise, the List waveform cannot be edited while the List is running.

4.8 Single Channel External Analog Function (Option)

This menu item is used to control the external analog function to enable or disable. The external analog interface is not the standard-equipped interface for the power supply.

This series power supply provides a optional DB-25 analog interface(IT-E1208). The analog interface provides the following capability:

- Remote control of output voltage and current
- Remote control of output On/Off state
- Remote monitoring of output voltage/current measurement and CC/CV mode
- Remote monitoring of output On/Off state, load status and fault status
- Clear the instrument malfunction
- RS-485 communication interface, please refer to [2.7.6 RS-485 Interface](#) for detailed description about the interface

The analog function implements voltage following mapping. The pin can accept a 0~10V input, which maps to a 0~full scale output on the DC side.

The definitions and descriptions for analog interface are as follows.

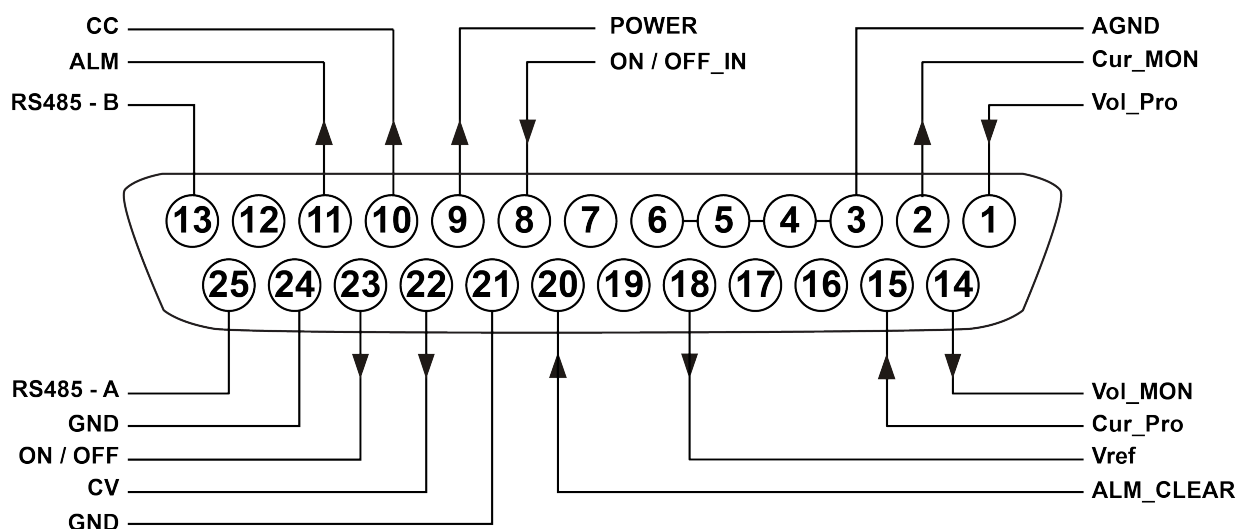

Pin	Name	Type	Description
1	VoI_Pro	Analog in	Programs output voltage. Use an input voltage in the range of 0 V to 10 V to control the output voltage in the range of 0 % to 100 %.
2	Cur_MON	Analog out	Current monitor signal. This pin generates a voltage of 0 V to 10 V to monitor an output current of 0 V to the maximum rated value. For example, if the maximum rated value is 60 A, and if the pin generates 2 V, the output voltage should be approximately 12 A
3/4/5/ 6	AGND	Ground	Ground for analog inputs and outputs.
7	-	-	Not used
8	ON / OFF_IN	Digital in	Receives the signal that is used to turn the output on or off. If a 0 V signal is applied, the output is turned off. If a 5 V signal is applied, the output is turned on.
9	Power	Digital out	Sends the signal that is used to indicate whether the output status is normal or not. If the power supply outputs normally, the pin generates 5 V. If the power supply malfunctions, the pin generates 0 V.
10	CC	Digital out	Sends the signal that is used to indicate the operation mode of the power supply. When the power supply is in CC mode, the pin generates 5 V. When the power supply is in CV mode, the pin generates 0 V.
11	ALM	Digital out	Sends the signal that is used to indicate whether the power supply malfunctions or not. When the power supply

Pin	Name	Type	Description
			operates well, the pin generates 5 V. When the power supply has a malfunction, the pin generates 0 V.
12	-	-	Not used
13, 25	RS485-B RS485-A	Communication interfaces	RS485 communication interfaces.
14	Vol_MON	Analog out	Voltage monitor signal. This pin generates a voltage of 0 V to 10 V to monitor an output voltage of 0 V to the maximum rated value. For example, if the maximum rated value is 80 V, and if the pin generates 2.5 V, the output voltage should be approximately 20 V
15	Cur_Pro	Analog in	Programs output current. Use an input voltage in the range of 0 V to 10 V to control the output current in the range of 0 % to 100 %.
16/17/ 19	-	-	Not used
18	Vref	Analog out	Signal output for external resistance control of the DC signal (produced by the internal signal source). Approximately 10 V. Connected to the external resistor.
20	ALM_CLEAR	Digital in	Signal input for clearing the instrument malfunction. If a 0 V signal is applied, the malfunction will not be cleared. If a 5 V signal is applied, the malfunction will be cleared.
21	GND	Ground	Ground for digital inputs and outputs.
22	CV	Digital out	Signal output for indicating the operation mode of the power supply. When the power supply is in CV mode, the pin generates 5 V; If the power supply is in CC mode, the pin generates 0 V.
23	ON / OFF	Digital out	Signal output for indicating the output On/Off status of the power supply. When the output is turned on, the pin generates 5 V; If the output is turned off, the pin generates 0 V.
24	GND	Ground	Ground for digital inputs and outputs.

CAUTION

- **Before connecting the hardware device that controls the analog interface, make sure that the hardware device does not output a voltage higher than 20% of the specified value to the pin, otherwise the instrument will be damaged. For example, when setting the voltage or current, the input voltage can't exceed 12V, otherwise the instrument will be damaged.**
- **In analog remote control mode, the analog signal input pin cannot be left floating. Before enabling the external analog function, verify that pin 1 (Vol_Pro) and pin 15 (Cur_Pro) are connected correctly. If the set value does not need to be adjusted, it can be fixed to a defined level, or directly connected to pin 18 (Vref), and the set value is directly set to the maximum rated value.**
- **Safe electrical isolation is set between this analog interface and output electrode. Do not connect any ground wire of the analog interface to the positive and negative terminals of the output interface.**

Enable/Disable Analog Control

To run this function, the power supply must be in the control of external analog control mode. The operation steps to set this menu item are as follows.

1. Press **[Shift]+[Display]** (System) keys to enter into the system menu.
2. Use left and right keys or rotate the knob to select **Comm** and press **[Enter]**.
3. Use left and right keys or rotate the knob to select **Ext-program** and press **[Enter]**.

Note

This menu is only displayed if the user has installed the analog interface. If there is no analog interface, this menu item is not displayed.

4. Rotate the knob to adjust the value.
 - Off: default value, indicates disable this function.
 - CH1: indicates enable the Analog function for CH1. Before enabling the external analog function, verify that pin 1 (Vol_Pro) and pin 15 (Cur_Pro) are connected correctly.
 - CH2: indicates enable the Analog function for CH2. Before enabling the external analog function, verify that pin 1 (Vol_Pro) and pin 15 (Cur_Pro) are connected correctly.

Alongside the **Ext-Program** menu, there is another menu called **Ext-Get**. The settings are described as follows.

- CH1: Reads the digital IO information corresponding to CH1.
- CH2: Reads the digital IO information corresponding to CH2.

Note

The digital IO information refers to the functions associated with pins 8, 9, 10, 11, 20, 22, and 23.

5. After finishing the setting, press **[Enter]** key to confirm.

Remote Control Using the Analog Interface

Different functions can be realized by different pins. The following examples of common voltage and current settings and voltage and current monitoring are used to explain how to wire and how to use them.

When controlling voltage and current settings via the analog interface, the rated output voltage or current can be controlled in the range of 0 % to 100 % using an input voltage in the range of 0 V to 10 V; Or the output voltage or current can be monitored in the range of 0 % to 100 % by the output voltage in the range of 0 V to 10 V. In parallel operation, you can program or monitor output through the master analog interface. The programming and monitoring range is changed to 0 % to 100 % range of parallel machine.

- Voltage Setting and Current Setting

This function can remotely change the voltage and current settings by sending an external analog signal.

- Voltage setting: Analog control of the output voltage can be accomplished by connecting external DC voltage sources in the range of 0 V to 10 V to the 1(Vol_Pro) and 3(AGND) pins.
- Current setting: Analog control of the output current can be accomplished by connecting external DC voltage sources in the range of 0 V to 10 V to the 15(Cur_Pro) and 4(AGND) pins.

Note

Before enabling the external analog function, verify that pin 1 (Vol_Pro) and pin 15 (Cur_Pro) are connected correctly.

The connection diagram is as follows:

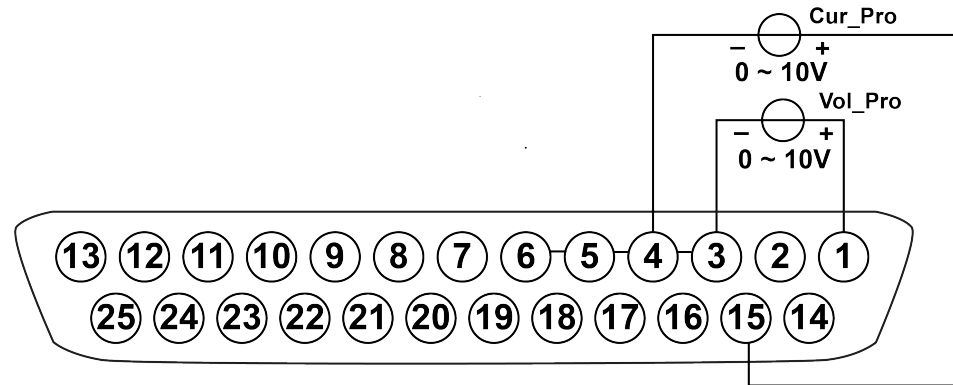

By connecting a voltage source to the Vol_Pro or Cur_Pro pins, a voltage setting from 0 to + 10 V corresponds to the zero to full-scale voltage or current setting of the power supply. For example, if the maximum rated value is 120 V, and if the voltage source is set to 5 V, the setting voltage should be approximately 60 V. If the maximum rated value is 30 A, and if the voltage source is set to 5 V, the setting current should be approximately 15 A.

- Voltage Monitoring and Current Monitoring

This function can monitor and read the output voltage and current values.

- Voltage monitoring: Output voltage values can be monitored and read by connecting a digital voltmeter to the 14(Vol_MON) and 5(AGND) pins.
- Current monitoring: Output current values can be monitored and read by connecting a digital voltmeter to the 2(Cur_MON) and 6(AGND) pins.

The connection diagram is as follows:

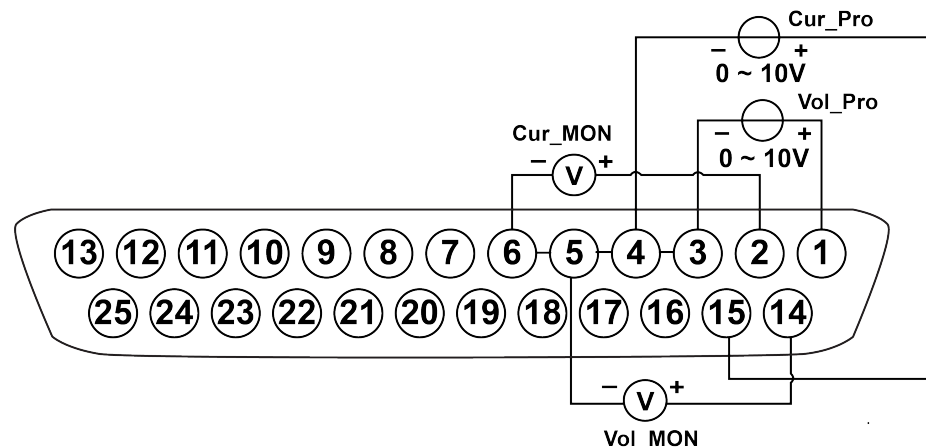

By connecting a digital voltmeter to the Vol_MON or Cur_MON pins, a voltage reading from 0 to + 10 V corresponds to the zero to full-scale voltage or current output of the power supply. For example, if the maximum rated value is 120 V, and if the pin 14 generates 2.5 V, the output voltage should be approximately 30 V. If the maximum rated value is 30 A, and if the pin 2 generates 2 V, the output current should be approximately 6 A.

4.9 Dual Channel External Analog Function (Option)

This menu item is used to control the external analog function to enable or disable. The external analog interface is not the standard-equipped interface for the power supply.

This series power supply provides an optional DB-25 analog interface (IT-E1208D). The analog interface provides the following capability:

- Remote control of output voltage and current
- Remote control of output On/Off state
- Remote monitoring of output voltage/current measurement and CC/CV mode
- Remote monitoring of output On/Off state, load status and fault status
- Clear the instrument malfunction
- RS-485 communication interface, please refer to [2.7.6 RS-485 Interface](#) for detailed description about the interface

The analog function implements voltage following mapping. The pin can accept a 0~10V input, which maps to a 0~full scale output on the DC side.

Unlike the IT-E1208 which offers single-channel control, the IT-E1208D can separately control two channels via external analog inputs. The specific pin definitions and descriptions are as follows.

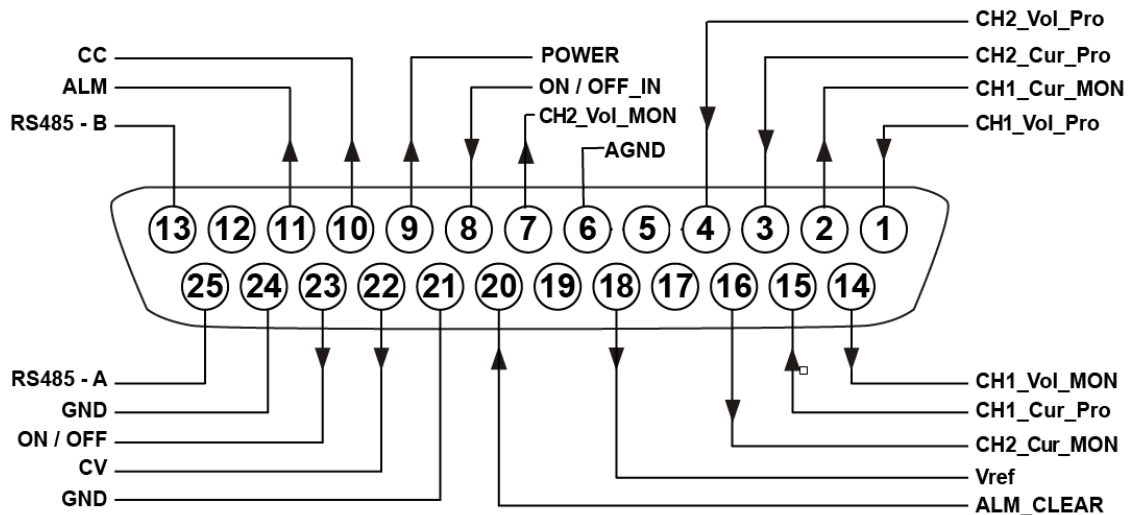

Pin	Name	Type	Description
1	CH1_Vol_Pro	CH1 Analog in	CH1 Programs output voltage. Use an input voltage in the range of 0 V to 10 V to control the output voltage in the range of 0 % to 100 %.
2	CH1_Cur_MON	CH1 Analog out	CH1 Current monitor signal. This pin generates a voltage of 0 V to 10 V to monitor an output current of 0 V to the maximum rated value. For example, if the maximum rated value is 60 A, and if the pin generates 2 V, the output voltage should be approximately 12 A
3	CH2_Cur_Pro	CH2 Analog in	CH2 Programs output current. Use an input voltage in the range of 0 V to 10 V to control the output current in the range of 0 % to 100 %.
4	CH2_Vol_Pro	CH2 Analog in	CH2 Programs output voltage. Use an input voltage in the range of 0 V to 10 V to control the output voltage in the range of 0 % to 100 %.
6	AGND	Ground	Ground for analog inputs and outputs.
7	CH2_Vol_MON	CH2 Analog out	CH2 Voltage monitor signal. This pin generates a voltage of 0 V to 10 V to monitor an output voltage of 0 V to the maximum rated value. For example, if the maximum rated value is 80 V, and if the pin generates 2.5 V, the output voltage should be approximately 20 V
8	ON / OFF_IN	Digital in	Receives the signal that is used to turn the output on or off. If a 0 V signal is applied, the output is turned off. If a 5 V signal is applied, the output is turned on.
9	Power	Digital out	Indicates whether the output status is normal or not. If the power supply outputs normally, the pin generates 5 V. If the power supply malfunctions, the pin generates 0 V.
10	CC	Digital out	Indicates the operation mode of the power supply. When the power supply is in CC mode, the pin generates 5 V. When the power supply is in CV mode, the pin generates 0 V.
11	ALM	Digital out	Indicates the instrument's fault status: if the instrument is functioning normally, it outputs 5V; if there is an anomaly, it outputs 0V.
12	–	–	Not used
13 and 25	RS485-B RS485-A	Communication interfaces	RS485 communication interfaces.
14	CH1_Vol_MON	CH1 Analog out	CH1 Voltage monitor signal. This pin generates a voltage of 0 V to 10 V to monitor an output voltage of 0 V to the maximum rated value. For example, if the maximum rated value is 80 V, and if the pin generates 2.5 V, the output voltage should be approximately 20 V
15	CH1_Cur_Pro	CH1 Analog in	CH1 Programs output current. Use an input voltage in the range of 0 V to 10 V to control the output current in the range of 0 % to 100 %.

Pin	Name	Type	Description
16	CH2_Cur_MON	CH2 Analog out	CH2 Current monitor signal. This pin generates a voltage of 0 V to 10 V to monitor an output current of 0 V to the maximum rated value. For example, if the maximum rated value is 60 A, and if the pin generates 2 V, the output voltage should be approximately 12 A
17/19	–	–	Not used
18	Vref	Analog out	The power supply's own 10V reference voltage can be directly connected to pin 1 (CH1_Vol_Pro) or pin 15 (CH1_Cur_Pro) to program the full-scale measurement settings, or the programming set values can be adjusted via a potentiometer.
20	ALM_CLEAR	Digital in	Signal input for clearing the instrument malfunction. If a 0 V signal is applied, the malfunction will not be cleared. If a 5 V signal is applied, the malfunction will be cleared.
21	GND	Ground	Ground for digital inputs and outputs.
22	CV	Digital out	Signal output for indicating the operation mode of the power supply. When the power supply is in CV mode, the pin generates 5 V; If the power supply is in CC mode, the pin generates 0 V.
23	ON / OFF	Digital out	Signal output for indicating the output On/Off status of the power supply. When the output is turned on, the pin generates 5 V; If the output is turned off, the pin generates 0 V.
24	GND	Ground	Ground for digital inputs and outputs.

CAUTION

- **Before connecting the hardware device that controls the analog interface, make sure that the hardware device does not output a voltage higher than 20% of the specified value to the pin, otherwise the instrument will be damaged. For example, when setting the voltage or current, the input voltage can't exceed 12V, otherwise the instrument will be damaged.**
- **Take the CH1 as an example, in analog remote control mode, the analog signal input pin cannot be left floating. Before enabling the external analog function, verify that pin 1 (CH1_Vol_Pro) and pin 15 (CH1_Cur_Pro) are connected correctly. If the set value does not need to be adjusted, it can be fixed to a defined level, or directly connected to pin 18 (Vref), and the set value is directly set to the maximum rated value.**
- **Safe electrical isolation is set between this analog interface and output electrode. Do not connect any ground wire of the analog interface to the positive and negative terminals of the output interface.**

Enable/Disable Analog Control

To run this function, the power supply must be in the control of external analog control mode. The operation steps to set this menu item are as follows.

1. Press **[Shift]+[Display]** (System) keys to enter into the system menu.
2. Use left and right keys or rotate the knob to select **Comm: RS485+BI-AI/O** and press **[Enter]**.
3. Use left and right keys or rotate the knob to select **Ext-program** and press **[Enter]**.
4. Rotate the knob to adjust the **Ext-Program** value.
 - Off: default value, indicates disable this function.
 - CH1: indicates enable the Analog function for CH1. Before enabling the external analog function, verify that pin 1 (CH1_Vol_Pro) and pin 15 (CH1_Cur_Pro) are connected correctly.
 - CH2: indicates enable the Analog function for CH2. Before enabling the external analog function, verify that pin 4 (CH2_Vol_Pro) and pin 3 (CH2_Cur_Pro) are connected correctly.
 - CH1+CH2: indicates that the analog functions of both CH1 and CH2 are enabled. Before enabling the external analog functions, please ensure that the corresponding pins are connected correctly.

Alongside the **Ext-Program** menu, there is another menu called **Ext-Get**. The settings are described as follows.

- CH1: Reads the digital IO information corresponding to CH1.
- CH2: Reads the digital IO information corresponding to CH2.



Note

The digital IO information refers to the functions associated with pins 8, 9, 10, 11, 20, 22, and 23.

5. After finishing the setting, press **[Enter]** key to confirm.

5 Specification

This chapter will introduce the rated voltage, current, power and many other main parameters of IT-M3100 series power supplies.

- ◆ IT-M3131D
- ◆ IT-M3132D
- ◆ IT-M3141D
- ◆ IT-M3142D
- ◆ Supplemental Characteristics

5.1 IT-M3131D

Parameter		Model: IT-M3131D CH1 & CH2
Rated value	Voltage	0 ~ 30V
	Current	0 ~ 15A
	Power	0 ~ 200W
	Resistance	\
Line Regulation \pm (% of Output +Offset)	Voltage	$\leq 0.02\% + 0.005\%FS$
	Current	$\leq 0.05\% + 0.01\%FS$
Load Regulation \pm (% of Output +Offset)	Voltage	$\leq 0.01\% + 0.008\%FS$
	Current	$\leq 0.05\% + 0.05\%FS$
Setup Resolution	Voltage	1mV
	Current	1mA
	Power	1W
	Resistance	\
Read Back Resolution	Voltage	1mV
	Current	1mA
	Power	1W
Setup Accuracy	Voltage	$\leq 0.03\% + 0.02\%FS$
	Current	$\leq 0.1\% + 0.1\%FS$
	Power	$\leq 1\% + 1\%FS$
	Resistance	\
Read Back Accuracy	Voltage	$\leq 0.03\% + 0.02\%FS$
	Current	$\leq 0.1\% + 0.1\%FS$

Parameter		Model: IT-M3131D CH1 & CH2
	Power	$\leq 1\% + 1\%FS$
Ripple (20hz-20Mhz)	Vpp	$\leq 60mVpp$
Ripple (20hz-300Khz)	Vrms	$\leq 10mV$
	Irms	$\leq 10mA$
Setup Temperature Coefficient (%of Output+Offset)/°C	Voltage	$\leq 0.005\% + 0.5mV$
	Current	$\leq 0.005\% + 0.5mA$
Read Back Temperature Coefficient (%of Output+Offset)/°C	Voltage	$\leq 0.005\% + 0.5mV$
	Current	$\leq 0.005\% + 0.5mA$
Rise Time(no load)	Voltage	$\leq 30ms$
Rise Time(full load)	Voltage	$\leq 30ms$
Fall Time(no load)	Voltage	$\leq 50ms$
Fall Time(full load)	Voltage	$\leq 10ms$
Transient Response Time	Voltage	$\leq 1ms$
AC Input	Voltage	100Vac ~ 240Vac (rated power)
	Frequency	50/60Hz
Setup stability-30min (%of Output +Offset)	Voltage	$\leq 0.01\% + 0.01\%FS$
	Current	$\leq 0.05\% + 0.03\%FS$
Setup stability-8h (%of Output +Offset)	Voltage	$\leq 0.01\% + 0.015\%FS$
	Current	$\leq 0.05\% + 0.05\%FS$
Readback stability-30min (%of Output +Offset)	Voltage	$\leq 0.01\% + 0.01\%FS$
	Current	$\leq 0.05\% + 0.03\%FS$
Readback stability-8h (%of Output +Offset)	Voltage	$\leq 0.01\% + 0.015\%FS$
	Current	$\leq 0.05\% + 0.05\%FS$
Efficiency		72%
Remote Sense Compensation Voltage		$\leq 2V$
Command Response Time		5ms
Power Factor		0.98
Maximum Input Current		6A
Maximum Input Apparent Power		600VA
Storage Temperature		-20°C ~ 70°C
Protective Function		OVP\OCP\OTP
Standard Interface		Optional GPIB, USB, LAN, CAN, RS232, RS485

Parameter	Model: IT-M3131D CH1 & CH2
Isolation (output to ground)	400Vdc
Isolation (input to ground)	1500Vac
Working Temperature	0 ~ 40°C
Fuse Specifications	T15A
Parallel Number	≤1
Series Number	≤1
Ingress Protection	IP20
Production Compliance	IEC 61010
Cooling	Air cooling
Dimensions without legs and terminals (mm)	214mmW*43.5mmH*450mmD
Overall dimension (mm)	234mmW*476mmD*52.9mmH
Weight(net)	(5±0.5)kg

5.2 IT-M3132D

Parameter		Model: IT-M3132D CH1/CH2
Rated value	Voltage	0 ~ 60V
	Current	0 ~ 10A
	Power	0 ~ 200W
	Resistance	\
Line Regulation ±(% of Out-put+Offset)	Voltage	≤0.02%+0.005%FS
	Current	≤0.05%+0.01%FS
Load Regulation ±(% of Out-put+Offset)	Voltage	≤0.01%+0.008%FS
	Current	≤0.05%+0.05%FS
Setup Resolution	Voltage	1mV
	Current	1mA
	Power	1W
	Resistance	\
Read Back Resolution	Voltage	1mV
	Current	1mA
	Power	1W
Setup Accuracy	Voltage	≤0.03% + 0.02%FS

Parameter		Model: IT-M3132D CH1/CH2
	Current	$\leq 0.1\% + 0.05\%FS$
	Power	$\leq 1\% + 1\%FS$
	Resistance	\
Read Back Accuracy	Voltage	$\leq 0.03\% + 0.02\%FS$
	Current	$\leq 0.1\% + 0.05\%FS$
	Power	$\leq 1\% + 1\%FS$
Ripple (20hz-20Mhz)	Vpp	$\leq 60mVpp$
Ripple (20hz-300Khz)	Vrms	$\leq 10mV$
	Irms	$\leq 8mA$
Setup Temperature Coefficient (%of Output+Offset)/ °C	Voltage	$\leq 0.005\% + 0.5mV$
	Current	$\leq 0.005\% + 0.5mA$
Read Back Temperature Coefficient (%of Output +Offset)/°C	Voltage	$\leq 0.005\% + 0.5mV$
	Current	$\leq 0.005\% + 0.5mA$
Rise Time(no load)	Voltage	$\leq 30ms$
Rise Time(full load)	Voltage	$\leq 30ms$
Fall Time(no load)	Voltage	$\leq 110ms$
Fall Time(full load)	Voltage	$\leq 30ms$
Transient Response Time	Voltage	$\leq 1ms$
AC Input	Voltage	100Vac ~ 240Vac (rated power)
	Frequency	50/60Hz
Setup stability-30min (%of Output +Offset)	Voltage	$\leq 0.01\% + 0.01\%FS$
	Current	$\leq 0.05\% + 0.03\%FS$
Setup stability-8h (%of Output +Offset)	Voltage	$\leq 0.01\% + 0.015\%FS$
	Current	$\leq 0.05\% + 0.05\%FS$
Readback stability-30min (%of Output +Offset)	Voltage	$\leq 0.01\% + 0.01\%FS$
	Current	$\leq 0.05\% + 0.03\%FS$
Readback stability-8h (%of Output +Offset)	Voltage	$\leq 0.01\% + 0.015\%FS$
	Current	$\leq 0.05\% + 0.05\%FS$
Efficiency		75%
Remote Sense Compensation Voltage		$\leq 2V$
Command Response Time		5ms
Power Factor		0.98

Parameter	Model: IT-M3132D CH1/CH2
Maximum Input Current	6A
Maximum Input Apparent Power	600VA
Storage Temperature	-20°C ~ 70°C
Protective Function	OVP\OCP\OTP
Standard Interface	Optional GPIB, USB, LAN, CAN, RS232, RS485
Isolation (output to ground)	400Vdc
Isolation (input to ground)	1500Vac
Working Temperature	0 ~ 40°C
Fuse Specifications	T15A
Parallel Number	≤1
Series Number	≤1
Ingress Protection	IP20
Production Compliance	IEC 61010
Cooling	Air cooling
Dimensions without legs and terminals (mm)	214mmW*43.5mmH*450mmD
Overall dimension (mm)	234mmW*476mmD*52.9mmH
Weight(net)	(5±0.5)kg

5.3 IT-M3141D

Parameter	Model: IT-M3141D CH1 & CH2	
Rated value	Voltage	0 ~ 30V
	Current	0 ~ 15A
	Power	0 ~ 400W
	Resistance	\
Line Regulation ±(% of Output+Offset)	Voltage	≤0.02%+0.005%FS
	Current	≤0.05%+0.01%FS
Load Regulation ±(% of Output+Offset)	Voltage	≤0.01%+0.008%FS
	Current	≤0.05%+0.05%FS
Setup Resolution	Voltage	1mV
	Current	1mA

Parameter		Model: IT-M3141D CH1 & CH2
	Power	1W
	Resistance	\
Read Back Resolution	Voltage	1mV
	Current	1mA
	Power	1W
Setup Accuracy	Voltage	$\leq 0.03\% + 0.02\%FS$
	Current	$\leq 0.1\% + 0.1\%FS$
	Power	$\leq 1\% + 1\%FS$
	Resistance	\
Read Back Accuracy	Voltage	$\leq 0.03\% + 0.02\%FS$
	Current	$\leq 0.1\% + 0.1\%FS$
	Power	$\leq 1\% + 1\%FS$
Ripple (20hz-20Mhz)	Vpp	$\leq 60mVpp$
Ripple (20hz-300Khz)	Vrms	$\leq 15mV$
	Irms	$\leq 15mA$
Setup Temperature Coefficient (% of Output + Offset) / °C	Voltage	$\leq 0.005\% + 0.5mV$
	Current	$\leq 0.005\% + 0.5mA$
Read Back Temperature Coefficient (% of Output + Offset) / °C	Voltage	$\leq 0.005\% + 0.5mV$
	Current	$\leq 0.005\% + 0.5mA$
Rise Time(no load)	Voltage	$\leq 30ms$
Rise Time(full load)	Voltage	$\leq 30ms$
Fall Time(no load)	Voltage	$\leq 50ms$
Fall Time(full load)	Voltage	$\leq 10ms$
Transient Response Time	Voltage	$\leq 1ms$
AC Input	Voltage	100Vac ~ 240Vac (rated power)
	Frequency	50/60Hz
Setup stability-30min (% of Output + Offset)	Voltage	$\leq 0.01\% + 0.01\%FS$
	Current	$\leq 0.05\% + 0.03\%FS$
Setup stability-8h (% of Output + Offset)	Voltage	$\leq 0.01\% + 0.015\%FS$
	Current	$\leq 0.05\% + 0.05\%FS$
Readback stability-30min (% of Output + Offset)	Voltage	$\leq 0.01\% + 0.01\%FS$
	Current	$\leq 0.05\% + 0.03\%FS$

Parameter		Model: IT-M3141D CH1 & CH2
Readback stability-8h (% of Output +Offset)	Voltage	$\leq 0.01\% + 0.015\%FS$
	Current	$\leq 0.05\% + 0.05\%FS$
Efficiency		85%
Remote Sense Compensation Voltage		$\leq 2V$
Command Response Time		5ms
Power Factor		0.98
Maximum Input Current		10A
Maximum Input Apparent Power		1kVA
Storage Temperature		$-20^{\circ}C \sim 70^{\circ}C$
Protective Function		OVP\OCP\OTP
Standard Interface		Optional GPIB, USB, LAN, CAN, RS232, RS485
Isolation (output to ground)		400Vdc
Isolation (input to ground)		1500Vac
Working Temperature		$0 \sim 40^{\circ}C$
Fuse Specifications		T15A
Parallel Number		≤ 1
Series Number		≤ 1
Ingress Protection		IP20
Production Compliance		IEC 61010
Cooling		Air cooling
Dimensions without legs and terminals (mm)		214mmW*43.5mmH*450mmD
Overall dimension (mm)		234mmW*476mmD*52.9mmH
Weight(net)		(5 \pm 0.5)kg

5.4 IT-M3142D

Parameter		Model: IT-M3142D CH1 & CH2
Rated value	Voltage	$0 \sim 60V$
	Current	$0 \sim 10A$
	Power	$0 \sim 400W$
	Resistance	\

Parameter		Model: IT-M3142D CH1 & CH2
Line Regulation \pm (% of Output+Offset)	Voltage	$\leq 0.02\% + 0.005\%FS$
	Current	$\leq 0.05\% + 0.01\%FS$
Load Regulation \pm (% of Output+Offset)	Voltage	$\leq 0.01\% + 0.008\%FS$
	Current	$\leq 0.05\% + 0.05\%FS$
Setup Resolution	Voltage	1mV
	Current	1mA
	Power	1W
	Resistance	\
Read Back Resolution	Voltage	1mV
	Current	1mA
	Power	1W
Setup Accuracy	Voltage	$\leq 0.03\% + 0.02\%FS$
	Current	$\leq 0.1\% + 0.1\%FS$
	Power	$\leq 1\% + 1\%FS$
	Resistance	\
Read Back Accuracy	Voltage	$\leq 0.03\% + 0.02\%FS$
	Current	$\leq 0.1\% + 0.1\%FS$
	Power	$\leq 1\% + 1\%FS$
Ripple (20hz-20Mhz)	Vpp	$\leq 60mVpp$
Ripple (20hz-300Khz)	Vrms	$\leq 15mV$
	Irms	$\leq 8mA$
Setup Temperature Coefficient (% of Output+Offset)/ $^{\circ}C$	Voltage	$\leq 0.005\% + 0.5mV$
	Current	$\leq 0.005\% + 0.5mA$
Read Back Temperature Coefficient (% of Output+Offset)/ $^{\circ}C$	Voltage	$\leq 0.005\% + 0.5mV$
	Current	$\leq 0.005\% + 0.5mA$
Rise Time(no load)	Voltage	$\leq 30ms$
Rise Time(full load)	Voltage	$\leq 30ms$
Fall Time(no load)	Voltage	$\leq 110ms$
Fall Time(full load)	Voltage	$\leq 30ms$
Transient Response Time	Voltage	$\leq 1ms$
AC Input	Voltage	100Vac ~ 240Vac (rated power)
	Frequency	50/60Hz

Parameter		Model: IT-M3142D CH1 & CH2
Setup stability-30min (%of Output +Offset)	Voltage	$\leq 0.01\% + 0.01\%FS$
	Current	$\leq 0.05\% + 0.03\%FS$
Setup stability-8h (%of Output +Offset)	Voltage	$\leq 0.01\% + 0.015\%FS$
	Current	$\leq 0.05\% + 0.05\%FS$
Readback stability-30min (%of Output +Offset)	Voltage	$\leq 0.01\% + 0.01\%FS$
	Current	$\leq 0.05\% + 0.03\%FS$
Readback stability-8h (%of Output +Offset)	Voltage	$\leq 0.01\% + 0.015\%FS$
	Current	$\leq 0.05\% + 0.05\%FS$
Efficiency		85%
Remote Sense Compensation Voltage		$\leq 2V$
Command Response Time		5ms
Power Factor		0.98
Maximum Input Current		10A
Maximum Input Apparent Power		1kVA
Storage Temperature		-20°C ~ 70°C
Protective Function		OVP\OCP\OTP
Standard Interface		Optional GPIB, USB, LAN, CAN, RS232, RS485
Isolation (output to ground)		400Vdc
Isolation (input to ground)		1500Vac
Working Temperature		0 ~ 40°C
Fuse Specifications		T15A
Parallel Number		≤ 1
Series Number		≤ 1
Ingress Protection		IP20
Production Compliance		IEC 61010
Cooling		Air cooling
Dimensions without legs and terminals (mm)		214mmW*43.5mmH*450mmD
Overall dimension (mm)		234mmW*476mmD*52.9mmH
Weight(net)		(5 \pm 0.5)kg

5.5 Supplemental Characteristics

State storage capacity: 10 sets

Recommended calibration frequency: once a year

Cooling style: fans

6 Routine Maintenance

This chapter describes the general maintenance items and maintenance methods of the DC power supply.

- ◆ Instrument Self-Test
- ◆ Cleaning and Maintenance
- ◆ Contact of ITECH Engineers
- ◆ Return for Repair

6.1 Instrument Self-Test

Self-test checks that the minimum set of logic and power mesh systems are functioning properly. Self-test does not enable the output or place any voltages on the output. Self-test can be achieved in two ways:

- Re-start the instrument. Each time the instrument is powered on, the self-test is performed. This test assumes that the instrument is running.
- SCPI command: *TST?. If the return value is 0, the self-test passes; if it is 1, the self-test fails. If the self-test fails, please send command **SYSTem:ER-Ror?** to view the self-test error. Please refer to *IT-M3100 Programming Guide* for the list of error codes.



Note

Ensure that all test cables connections are removed when self-test is performed. During self-test, errors may be induced by signals present on external wiring, such as long test leads that can act as antennae.

6.2 Cleaning and Maintenance

To ensure the safety function and performance of the instrument, please clean and maintain the instrument properly.

WARNING

- **To prevent electrical shock, disconnect the instrument from AC mains power and disconnect all test leads before cleaning.**
 - **Do not use detergent or solvents.**
 - **Do not disassemble the instrument and attempt to clean internally.**
-

Clean the outside and the front panel screen of the instrument using a soft, lint-free, cloth slightly dampened with water. Use a brush to clean the dust on the vent and cooling fans.

6.3 Contact of ITECH Engineers

This section describes operations to be carried out by the user in case of failure of the instrument.

Preparation before contact

When the instrument fails, you should make the following preparations before returning the instrument to ITECH for repair or contacting engineers.

- Check all the items listed in the [Self-inspection of equipment faults](#) and confirm whether there are still some problems.
- Collect the SN of the instrument.
For details, see [Collect the SN number](#).

If there are still some problems, carefully read the **Warranty** and **Limitation of Warranty** in the preface of the manual. Confirm that your instrument complies with warranty service conditions. If after your warranty expires, ITECH offers repair services at competitive prices.

Self-inspection of equipment faults

When the instrument fails, make the following checks to ensure that the failure is in the instrument rather than any external connections. If the instrument failure can be eliminated via simple inspection, the maintenance cost and time can be saved.

- Check whether the AC power cord is securely connected to the instrument and to a powered outlet.
- Check whether the front-panel Power On switch has been pushed.
- Check whether self-inspection of the instrument is successful and whether the specifications and performance are within the indicator ranges.

- Check whether the instrument displays error information.
- Use other instruments instead of this instrument for confirmation.

Collect the SN number

ITECH will constantly improve the product performance, availability and reliability. The service personnel of ITECH will record changes of each instrument. All relevant information is marked uniquely according to the serial number of each instrument. The equipment returned for repair must adopt the SN number as the tracking ID.

When you contact the engineer, the effective SN number of the instrument will be the effective guarantee for effective service and complete information. You can obtain the SN number of the instrument by the following ways:

1. Press **[Shift]+[Display]** (System) to enter into the system menu interface.
2. Use left and right keys or rotate the knob to select **System Info** and press **[Enter]** key.
3. Use left and right keys or knob to view the SN number.

Please record the SN number and provide SN information when doing maintenance service.

How to contact ITECH engineers

Access ITECH official website www.itechate.com or call the service number 4006-025-000 for technical support and services.

6.4 Return for Repair

If your instrument fails during the warranty period, ITECH will repair or replace it under the terms of your warranty. After your warranty expires, ITECH offers repair services at competitive prices. Also you can purchase an extended maintenance service contract that exceeds the standard warranty period.

Get Repair Service

To get the service for your instrument, choose the easiest way to contact the ITECH engineers. ITECH will arrange for repair or replacement of your instrument or provide warranty and repair cost information (if applicable).

Repackaging for Shipment

CAUTION

Never use styrene pellets in any shape as packaging materials. They do not adequately cushion the instrument or prevent it from shifting in the carton. Styrene pellets cause the instrument damage by generating static electricity and by lodging in the rear panel.

ITECH recommends that you retain the original shipping carton for return shipments and always insure shipments. To ship the unit to ITECH for service or repair:

1. Download the **ITECH maintenance service application** from our website, complete it and place it in the box with the instrument.
2. Place the unit in its original container with appropriate packaging material.

If the original shipping container is unavailable, use a container that will ensure at least 10 cm (4 in.) of compressible packaging material around the entire instrument. Use static-free packaging materials.

3. Secure the container with strong tape or metal bands.

A Appendix

◆ Specifications of Red and Black Test Cables

A.1 Specifications of Red and Black Test Cables

ITECH provides you with optional red and black test cables, which are sold individually and you can select for test. For specifications of ITECH test cables and maximum current values, refer to the table below.

Model	Specification
IT-E30110-AB	1kV/10A/1m*2pcs Alligator clips-Banana plugs
IT-E30110-BB	1kV/10A/1m*2pcs Banana plugs-Banana plugs
IT-E30110-BY	1kV/10A/1m*2pcs Banana plugs-Y-type terminals
IT-E30312-YY	500V/30A/1.2m*2pcs Y-type terminals-Y-type terminals
IT-E30320-YY	500V/30A/2m*2pcs Y-type terminals-Y-type terminals
IT-E30615-OO	500V/60A/1.5m*2pcs Ring terminals-Ring terminals
IT-E31005LIC-OO	600V/100A/0.5m*2pcs Ring terminal low inductance
IT-E31010LIC-OO	600V/100A/1m*2pcs Ring terminal low inductance
IT-E31020LIC-OO	600V/100A/2m*2pcs Ring terminal low inductance
IT-E31040LIC-OO	600V/100A/2m*2pcs Ring terminal low inductance
IT-E31220-OO	500V/120A/2m*2pcs Ring terminals-Ring terminals
IT-E31250-OO	500V/120A/5m*2pcs Ring terminals-Ring terminals
IT-E32410-OO	500V/240A/1m*2pcs Ring terminals-Ring terminals
IT-E32420-OO	500V/240A/2m*2pcs Ring terminals-Ring terminals
IT-E32450-OO	500V/240A/5m*2pcs Ring terminals-Ring terminals
IT-E3301020-OO	3kV/100A/2m*2pcs Ring terminals-Ring terminals
IT-E3301050-OO	3kV/100A/5m*2pcs Ring terminals-Ring terminals
IT-E3302420-OO	3kV/240A/2m*2pcs Ring terminals-Ring terminals
IT-E3302450-OO	3kV/240A/5m*2pcs Ring terminals-Ring terminals

IT-E3303620-OO	3kV/360A/2m*2pcs Ring terminals-Ring terminals
IT-E3304020-OO	3kV/400A/2m*2pcs Ring terminals-Ring terminals
IT-E33620-OO	500V/360A/2m*2pcs Ring terminals-Ring terminals
IT-E33650-OO	500V/360A/5m*2pcs Ring terminals-Ring terminals
IT-E34020-OO	500V/400A/2m*2pcs Ring terminals-Ring terminals
IT-E34520-OO	500V/450A/2m*2pcs Ring terminals-Ring terminals
IT-E35030-OO	500V/360A/3m*2pcs Ring terminals-Ring terminals
IT-E36530-OO	500V/650A/3m*2pcs Ring terminals-Ring terminals

For maximum current of AWG copper wire, refer to table below.

AWG	8	10	12	14	16	18	20	22	24	26	28
The Maximum Current Value (A)	60	40	30	20	13	10	7	5	3.5	2.5	1.7



Note

- AWG (American Wire Gage), it means X wire (marked on the wire). The table above lists current capacity of single wire at working temperature of 30°C. For reference only.
- Along with temperature, you must also consider voltage drop when selecting wire sizes.

Although the instrument will compensate for the voltage in the wires, it is recommended to minimize the voltage drop as much as possible to prevent excessive power consumption from the instrument and poor dynamic response to load changes. Larger diameter wire sizes will help minimize wire voltage drops. Twisting or bundling wires will help reduce transient voltage drops.

Connect with us

Thank you for purchasing ITECH products. Any questions, pls. feel free to let us know.

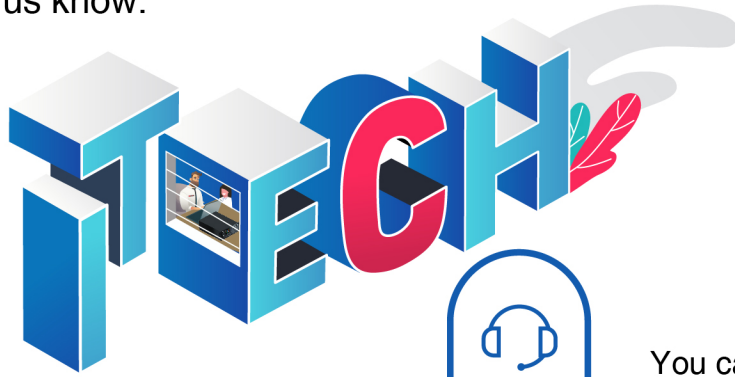

You can chat with us on ITECH website



For more information, pls. visit www.itechate.com



Click and follow ITECH Electronics

