

Programmable DC Power Supply

IT-M3140 Programming Guide



Notices

© Itech Electronic, Co., Ltd. 2022
No part of this manual may be reproduced in any form or by any means (including electronic storage and retrieval or translation into a foreign language) without prior permission and written consent from Itech Electronic, Co., Ltd. as governed by international copyright laws.

Manual Part Number

IT-M3140-400000

Revision

1st Edition: Sep. 28, 2022
Itech Electronic, Co., Ltd.

Trademarks

Pentium is U.S. registered trademarks of Intel Corporation.

Microsoft, Visual Studio, Windows and MS Windows are registered trademarks of Microsoft Corporation in the United States and/or other countries and regions.

Warranty

The materials contained in this document are provided "as is", and is subject to change, without prior notice, in future editions. Further, to the maximum extent permitted by applicable laws, ITECH disclaims all warranties, either express or implied, with regard to this manual and any information contained herein, including but not limited to the implied warranties of merchantability and fitness for a particular purpose. ITECH shall not be held liable for errors or for incidental or indirect damages in connection with the furnishing, use or application of this document or of any information contained herein. Should ITECH and the user enter into a separate written agreement with warranty terms covering the materials in this document that conflict with these terms, the warranty terms in the separate agreement shall prevail.

Technology Licenses

The hardware and/or software described herein are furnished under a license and may be used or copied only in accordance with the terms of such license.

Restricted Rights Legend

Restricted permissions of the U.S. government. Permissions for software and technical data which are authorized to the U.S. Government only include those for custom provision to end users. ITECH provides this customary commercial license in software and technical data pursuant to FAR 12.211 (Technical Data) and 12.212 (Computer Software) and, for the Department of Defense, DFARS 252.227-7015 (Technical Data – Commercial Items) and DFARS 227.7202-3 (Rights in Commercial Computer Software or Computer Software Documentation).

Safety Notices

CAUTION

A CAUTION sign denotes a hazard. It calls attention to an operating procedure or practice that, if not correctly performed or adhered to, could result in damage to the product or loss of important data. Do not proceed beyond a CAUTION sign until the indicated conditions are fully understood and met.

WARNING

A WARNING sign denotes a hazard. It calls attention to an operating procedure or practice that, if not correctly performed or adhered to, could result in personal injury or death. Do not proceed beyond a WARNING sign until the indicated conditions are fully understood and met.



NOTE

A NOTE sign denotes important hint. It calls attention to tips or supplementary information that is essential for users to refer to

Quality Certification and Assurance

We certify that IT-M3140 power supply meets all the published specifications at time of shipment from the factory.

Warranty

ITECH warrants that the product will be free from defects in material and workmanship under normal use for a period of one (1) year from the date of delivery (except those described in the Limitation of Warranty below).

For warranty service or repair, the product must be returned to a service center designated by ITECH.









- The product returned to ITECH for warranty service must be shipped PREPAID. And ITECH will pay for return of the product to customer.
- If the product is returned to ITECH for warranty service from overseas, all the freights, duties and other taxes shall be on the account of customer.







Limitation of Warranty

This Warranty will be rendered invalid in case of the following:

- Damage caused by circuit installed by customer or using customer own products or accessories;
- Modified or repaired by customer without authorization;
- Damage caused by circuit installed by customer or not operating our products under designated environment;
- The product model or serial number is altered, deleted, removed or made illegible by customer;
- Damaged as a result of accidents, including but not limited to lightning, moisture, fire, improper use or negligence.

Safety Symbols

	Direct current		ON (power on)
	Alternating current		OFF (power off)
	Both direct and alternating current		Power-on state
	Protective conductor terminal		Power-off state

	Earth (ground) terminal		Reference terminal
	Caution, risk of electric shock		Positive terminal
	Warning, risk of danger (refer to this manual for specific Warning or Caution information)		Negative terminal
	Frame or chassis terminal	-	-

Safety Precautions

The following safety precautions must be observed during all phases of operation of this instrument. Failure to comply with these precautions or specific warnings elsewhere in this manual will constitute a default under safety standards of design, manufacture and intended use of the instrument. ITECH assumes no liability for the customer's failure to comply with these precautions.

WARNING

- Do not use the instrument if it is damaged. Before operation, check the casing to see whether it cracks. Do not operate the instrument in the presence of inflammable gasses, vapors or dusts.
- The power supply is provided with a three-core power line during delivery and should be connected to a three-core junction box. Before operation, be sure that the instrument is well grounded.
- Make sure to use the power cord supplied by ITECH.
- Check all marks on the instrument before connecting the instrument to power supply.
- Use electric wires of appropriate load. All loading wires should be capable of bearing maximum short-circuit current of power supply without overheating. If there are multiple electronic loads, each pair of the power cord must be capable of bearing the full-loaded rated short-circuit output current.
- Ensure the voltage fluctuation of mains supply is less than 10% of the working voltage range in order to reduce risks of fire and electric shock.
- Do not install alternative parts on the instrument or perform any unauthorized modification.
- Do not use the instrument if the detachable cover is removed or loosen.
- To prevent the possibility of accidental injuries, be sure to use the power adapter supplied by the manufacturer only.
- We do not accept responsibility for any direct or indirect financial damage or loss of profit that might occur when using the instrument.
- This instrument is used for industrial purposes, do not apply this product to IT power supply system.

- Never use the instrument with a life-support system or any other equipment subject to safety requirements.

CAUTION

- Failure to use the instrument as directed by the manufacturer may render its protective features void.
- Always clean the casing with a dry cloth. Do not clean the internals.
- Make sure the vent hole is always unblocked.

Environmental Conditions

The instrument is designed for indoor use and an area with low condensation. The table below shows the general environmental requirements for the instrument.



Environmental Conditions	Requirements
Operating temperature	0°C to 40°C
Operating humidity	20%-80% (non-condensation)
Storage temperature	-20°C to 70 °C
Altitude	Operating up to 2,000 meters
Pollution degree	Pollution degree 2
Installation category	II



Note

To make accurate measurements, allow the instrument to warm up for 30 min before operation.

Regulatory Markings

	<p>The CE mark indicates that the product complies with all the relevant European legal directives. The specific year (if any) affixed refers to the year when the design was approved.</p>
	<p>The instrument complies with the WEEE Directive (2002/96/EC) marking requirement. This affixed product label indicates that you must not discard the electrical/electronic product in domestic household waste.</p>

	<p>This symbol indicates the time period during which no hazardous or toxic substances are expected to leak or deteriorate during normal use. The expected service life of the product is 10 years. The product can be used safely during the 10-year Environment Friendly Use Period (EFUP). Upon expiration of the EFUP, the product must be immediately recycled.</p>
---	--

Waste Electrical and Electronic Equipment (WEEE) Directive



2002/96/EC Waste Electrical and Electronic Equipment (WEEE) Directive

This product complies with the WEEE Directive (2002/96/EC) marking requirement. This affix product label indicates that you must not discard the electrical/electronic product in domestic household waste.

Product Category

With reference to the equipment classifications described in the Annex I of the WEEE Directive, this instrument is classified as a "Monitoring and Control Instrument".

To return this unwanted instrument, contact your nearest ITECH office.

Compliance Information

Complies with the essential requirements of the following applicable European Directives, and carries the CE marking accordingly:

- Electromagnetic Compatibility (EMC) Directive 2014/30/EU
- Low-Voltage Directive (Safety) 2014/35/EU

Conforms with the following product standards:

EMC Standard

IEC 61326-1:2012/ EN 61326-1:2013 ¹²³

Reference Standards

CISPR 11:2009+A1:2010/ EN 55011:2009+A1:2010 (Group 1, Class A)

IEC 61000-4-2:2008/ EN 61000-4-2:2009

IEC 61000-4-3:2006+A1:2007+A2:2010/ EN 61000-4-3:2006+A1:2008+A2:2010

IEC 61000-4-4:2004+A1:2010/ EN 61000-4-4:2004+A1:2010

IEC 61000-4-5:2005/ EN 61000-4-5:2006

IEC 61000-4-6:2008/ EN 61000-4-6:2009

IEC 61000-4-11:2004/ EN 61000-4-11:2004

1. The product is intended for use in non-residential/non-domestic environments. Use of the product in residential/domestic environments may cause electromagnetic interference.
2. Connection of the instrument to a test object may produce radiations beyond the specified limit.
3. Use high-performance shielded interface cable to ensure conformity with the EMC standards listed above.

Safety Standard

IEC 61010-1:2010/ EN 61010-1:2010

Content

Quality Certification and Assurance	i
Warranty	i
Limitation of Warranty	i
Safety Symbols	i
Safety Precautions	ii
Environmental Conditions	iii
Regulatory Markings	iii
Waste Electrical and Electronic Equipment (WEEE) Directive	iv
Compliance Information	v
Chapter1 SCPI Introduction	1
1.1 Overview	1
1.2 Command Type of SCPI	1
1.3 Message Type of SCPI	3
1.4 Response Data Type	4
1.5 Command Format	5
1.6 Data Type	7
1.7 Remote Interface Connections	8
Chapter2 Status register	10
Chapter3 Output Commands	13
OUTPut[:STATe] <bool>	13
[OUTPut:]PROTection:CLEAr	13
OUTPut:DELAy[:ON] <NRf+>	14
OUTPut:DELAy:OFF <NRf+>	14
OUTPut:TIMer[:STATe] <bool>	15
OUTPut:TIMer:DATA <NRf+>	15
OUTPut:TIMer:DELAy <NRf+>	16
OUTPut:PROTection:FOLDBack[:MODE] <OFF CC CV>	16
OUTPut:PROTection:FOLDBack:DELAy <NRf+>	17
OUTPut:INHibit:MODE <CPD>	17
OUTPut:INHibit:POLarity <CPD>	18
[OUTPut:]PROTection:WDOG[:STATe] <Bool>	18
OUTPut:PROTection:WDOG:DELAy [MINimum MAXimum]	19
Chapter4 Measurement Commands	20
MEASure[:SCALar]:CURRent[:DC]?	20
FETCh[:SCALar]:CURRent[:DC]?	20
MEASure[:SCALar]:POWEr[:DC]?	20
FETCh[:SCALar]:POWEr[:DC]?	21
MEASure[:SCALar]:VOLTage[:DC]?	21
FETCh[:SCALar]:VOLTage[:DC]?	22
MEASure:ALL?	22
FETCh:ALL?	23
FETCh:TIME?	23

Chapter5	Sense Commands	24
	SENSE[:REMOte][:STATe] <bool>	24
	SENSE:FILTer:LEVel <SLOW MEDium FAST>	24
Chapter6	Source Commands	26
	[SOURce:]CURRent[:LEVel][:IMMediate][:AMPLitude] <NRf+>	26
	[SOURce:]CURRent[:LEVel]:TRIGgered[:AMPLitude] <NRf+>	26
	[SOURce:]CURRent[:OVER]:PROTection[:LEVel] <NRf+>	27
	[SOURce:]CURRent[:OVER]:PROTection:DELAy <NRf+>	27
	[SOURce:]CURRent[:OVER]:PROTection:STATe <bool>	28
	[SOURce:]CURRent:UNDer:PROTection[:LEVel] <NRf+>	28
	[SOURce:]CURRent:UNDer:PROTection:DELAy <NRf+>	29
	[SOURce:]CURRent:UNDer:PROTection:STATe <bool>	29
	[SOURce:]CURRent:UNDer:PROTection:WARM <NRf+>	30
	[SOURce:]CURRent:SLEW[:BOTH] <NRf+>	30
	[SOURce:]CURRent:SLEW:NEGative <NRf+>	31
	[SOURce:]CURRent:SLEW:POSitive <NRf+>	31
	[SOURce:]VOLTage[:LEVel][:IMMediate][:AMPLitude] <NRf+>	32
	[SOURce:]VOLTage[:LEVel]:TRIGgered[:AMPLitude] <NRf+>	32
	[SOURce:]VOLTage:SLEW[:BOTH] <NRf+>	33
	[SOURce:]VOLTage:SLEW:NEGative <NRf+>	33
	[SOURce:]VOLTage:SLEW:POSitive <NRf+>	34
	[SOURce:]VOLTage[:OVER]:PROTection[:LEVel] <NRf+>	34
	[SOURce:]VOLTage[:OVER]:PROTection:DELAy <NRf+>	35
	[SOURce:]VOLTage[:OVER]:PROTection:STATe <bool>	35
	[SOURce:]VOLTage:UNDer:PROTection[:LEVel] <NRf+>	36
	[SOURce:]VOLTage:UNDer:PROTection:DELAy <NRf+>	36
	[SOURce:]VOLTage:UNDer:PROTection:STATe <bool>	37
	[SOURce:]VOLTage:UNDer:PROTection:WARM <NRf+>	37
	[SOURce:]VOLTage[:LEVel]:LIMit[:HIGH] <NRf+>	38
	[SOURce:]VOLTage[:LEVel]:LIMit:LOW <NRf+>	38
	[SOURce:]POWER[:LEVel][:IMMediate][:AMPLitude] <NRf+>	39
	[SOURce:]POWER:PROTection[:LEVel] <NRf+>	39
	[SOURce:]POWER:PROTection:DELAy <NRf+>	40
	[SOURce:]POWER:PROTection:STATe <Bool>	40
	[SOURce:]FUNCTion:MODE <CPD>	41
	[SOURce:]FUNCTion:PRiority <CPD>	41
	[SOURce:]APPLY <NRf+>,<NRf+>	42
	[SOURce:]EXTernal[:PROGram] [:STATe] <bool>	43
	[SOURce:]BLEeder[:STATe]	43
	[SOURce:]EXTernal[:PROGram][:CHANnel]:MX <NR1>,<NRf+>	44
	[SOURce:]EXTernal[:PROGram][:CHANnel]:MB <NR1>,<NRf+>	44
	[SOURce:]RESistance[:LEVel][:IMMediate][:AMPLitude] <NRf+>	45
Chapter7	System Commands	46
	SYSTem:BEEPer:IMMediate	46

SYSTem:BEEPer[:STATe] <bool>	46
SYSTem:VERSion?	47
SYSTem:ERRor?	47
SYSTem:REMote	47
SYSTem:LOCal	48
SYSTem:RWLock	48
SYSTem:KEY <NR1>	49
SYSTem:REBoot	49
SYSTem:COMMunicate:GPIB[:SELF]:ADDRess <NR1>	50
SYSTem:COMMunicate:LAN:CURRent:ADDRess <SPD>	51
SYSTem:COMMunicate:LAN:CURRent:DGATeway <SPD>	51
SYSTem:COMMunicate:LAN:CURRent:SMASK <SPD>	52
SYSTem:COMMunicate:LAN:DHCP <bool>	52
SYSTem:COMMunicate:LAN:SOCKetport <NR1>	53
SYSTem:COMMunicate:LAN:MACAddress?	53
SYSTem:COMMunicate:SERial:BAUDrate <CPD>	54
SYSTem:COMMunicate:LAN:DNS1 <SPD>	54
SYSTem:COMMunicate:LAN:DNS2 <SPD>	55
SYSTem:COMMunicate:LAN:RESTore	55
SYSTem:COMMunicate:LAN:SAVE	56
SYSTem:COMMunicate:LAN:STATe?	56
SYSTem:COMMunicate:LAN:HOSTname?	56
SYSTem:COMMunicate:LAN:DESCRiption?	57
SYSTem:COMMunicate:LAN:DOMain?	57
SYSTem:POSetup <CPD>	58
SYSTem:READy?	58
Chapter8 List Commands	60
LIST:STEP:COUNT <NR1>	60
LIST:STEP:VOLTage <NR1>,<NRf+>	60
LIST:STEP:CURRent <NR1>,<NRf+>	61
LIST:STEP:SLEW <NR1>,<NRf+>	61
LIST:STEP:WIDTh <NR1>,<NRf+>	62
LIST:REPeat <NR1>	62
LIST:FUNcTion <CPD>	63
LIST:SAVE <NR1>	63
LIST:RECall <NR1>	64
LIST[:STATe] <bool>	64
LIST:TERMinate <CPD>	65
LIST:PAUSe[:STATe] <bool>	65
LIST:RUN:STEP?	66
LIST:RUN:REPeat?	66
Chapter9 Trace Commands	67
TRACe:CLEar	67
TRACe:POINts <NR1>	67
TRACe:FEED:CONTRol <CPD>	68

TRACe:FEED[:SElected] <CPD>	68
TRACe:DElay <NRf+>	69
TRACe:TIMer <NRf+>	69
TRACe:POINts:ACTual?.....	70
TRACe:DATA?	70
TRACe:FILTer[:STATe] <bool>.....	71
Chapter10 DISPlay Commands.....	72
DISPlay[:WINDow][:STATe] <bool>.....	72
DISPlay[:WINDow]:TEXT <SPD>	72
DISPlay[:WINDow]:TEXT:CLEar	73
DISPlay[:WINDow]:MODE <CPD>.....	73
Chapter11 STATus Commands.....	74
STATus:OPERation[:EVENT]?	74
STATus:OPERation:CONDition?	74
STATus:OPERation:ENABLE <NR1>	75
STATus:OPERation:NTRansition <NR1>	75
STATus:OPERation:PTRansition <NR1>	76
STATus:QUEStionable[:EVENT]?	76
STATus:QUEStionable:CONDition?	76
STATus:QUEStionable:ENABLE <NR1>	77
STATus:QUEStionable:NTRansition <NR1>	77
STATus:QUEStionable:PTRansition <NR1>.....	78
STATus:PRESet	78
Chapter12 TRIGger Commands	80
TRIGger[:IMMEdiate]	80
TRIGger:SOURce <CPD>	80
TRIGger:EXTernal:DIRection <CPD>.....	81
Chapter13 COMMon Commands	82
*CLS.....	82
*ESE.....	82
*ESR?.....	83
*IDN?.....	83
*OPC.....	84
*PSC <Boolean>	84
*RCL <NRf>.....	85
*RST.....	85
*SAV	86
*SRE	86
*STB?.....	87
*TRG.....	87
*TST?	88
*WAI.....	88
Chapter14 PRoGRAMMING Examples	90

Example1: Identifying the Power Supply in Use.....	90
Example2: Setting the Common Output Arguments	90
Example3: List Function.....	91
Chapter15 Error Messages.....	93
Error List.....	93

Chapter1 SCPI Introduction

1.1 Overview

SCPI is short for Standard Commands for Programmable Instruments which defines a communication method of bus controller and instrument. It is based on ASCII and supply for testing and measuring instruments. SCPI command is based on hierarchical architecture which also known as tree system. In this system, Relevant Command is returned to a common node or root, so that a subsystem is formed.

1.2 Command Type of SCPI

SCPI has two types of commands, common and subsystem.

- Common commands generally are not related to specific operation but to controlling overall instrument functions, such as reset, status, and synchronization. All common commands consist of a three-letter mnemonic preceded by an asterisk: ***RST *IDN? *SRE 8**.
- Subsystem commands perform specific instrument functions. They are organized into an inverted tree structure with the "root" at the top. The following figure shows a portion of a subsystem command tree, from which you access the commands located along the various paths.

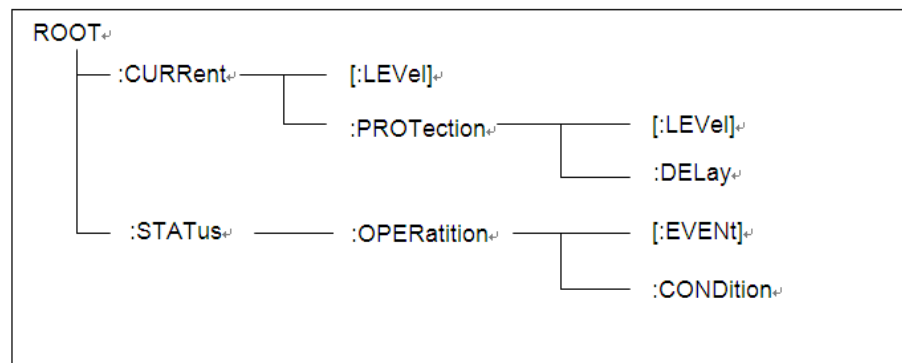

Multiple Commands in a Message

Multiple SCPI commands can be combined and sent as a single message with one message terminator. There are two important considerations when sending several commands within a single message:

- Use a semicolon to separate commands within a message.
- Head paths influence how the instrument interprets commands.

We consider the head path as a string which will be inserted in front of every command of a message. As for the first command of a message, the head path is a null string; for each subsequent command, the head path is a string which is defined to form the current command until and including the head of the last colon separator. A message with two combined commands:

CURR:LEV 3;PROT:STAT OFF

The example indicates the effect of semicolon and explains the concept of head path. Since the head path is defined to be "CURR" after "curr: lev 3", the head of the second command, "curr", is deleted and the instrument explains the second command as:

CURR:PROT:STAT OFF

If "curr" is explicitly included in the second command, it is semantically wrong. Since combining it with the head path will become "CURR:CURR:PROT:STAT OFF", resulting in wrong command.

Movement in the Subsystem

In order to combine commands from different subsystems, you need to be able to reset the header path to a null string within a message. You do this by beginning the command with a colon (:), which discards any previous header path. For example, you could clear the output protection and check the status of the Operation Condition register in one message by using a root specifier as follows:

PROTection:CLEAr;;STATus:OPERation:CONDition?

The following message shows how to combine commands from different subsystems as well as within the same subsystem:

POWer:LEVel 200;PROTection 28; :CURRent:LEVel 3;PROTection:STATe ON

Note the use of the optional header LEVel to maintain the correct path within the voltage and current subsystems, and the use of the root specifier to move between subsystems.

Including Common Commands

You can combine common commands with subsystem commands in the same message. Treat the common command as a message unit by separating it with a semicolon (the message unit separator). Common commands do not affect the header path; you may insert them anywhere in the message.

**VOLTage:TRIGgered 17.5;;INITialize;*TRG
OUTPut OFF;*RCL 2;OUTPut ON**

Case Sensitivity

Common commands and SCPI commands are not case sensitive. You can use upper or lower, for example:

***RST = *rst**
:DATA? = :data?
:SYSTem:PRESet = :system:preset

Long-Form and Short-Form Versions

A SCPI command word can be sent in its long-form or short-form version.

However, the short-form version is indicated by upper case characters. Examples:

:**SYSTem:PRESet** long-form

:**SYST:PRES** short form

:**SYSTem:PRES** long-form and short-form combination

Note that each command word must be in long-form or short-form, and not something in between.

For example, **:SYSTe:PRESe** is illegal and will generate an error. The command will not be executed.

Query

Observe the following precautions with queries:

- Set up the proper number of variables for the returned data. For example, if you are reading back a measurement array, you must dimension the array according to the number of measurements that you have placed in the measurement buffer.
- Read back all the results of a query before sending another command to the instrument. Otherwise a Query Interrupted error will occur and the unreturned data will be lost.

1.3 Message Type of SCPI

There are two types of SCPI messages, program and response.

- Program message: A program message consists of one or more properly formatted SCPI commands sent from the controller to the instrument. The message, which may be sent at any time, requests the instrument to perform some action.
- Response message: A response message consists of data in a specific SCPI format sent from the instrument to the controller. The instrument sends the message only when commanded by a program message called a "query."

The next figure illustrates SCPI message structure:

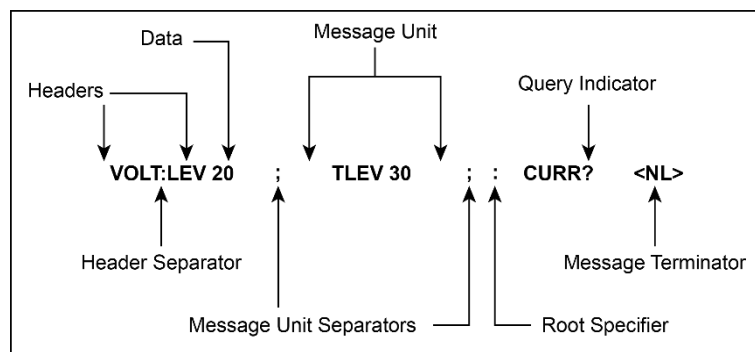

The message unit

The simplest SCPI command is a single message unit consisting of a command header (or keyword) followed by a message terminator. The message unit may

include a parameter after the header. The parameter can be numeric or a string.

ABORt<NL>

VOLTage 20<NL>

Headers

Headers, also referred to as keywords, are instructions recognized by the instrument. Headers may be either in the long form or the short form. In the long form, the header is completely spelled out, such as VOLTAGE, STATUS and DELAY. In the short form, the header has only the first three or four letters, such as VOLT, STAT and DEL.

Query indicator

Following a header with a question mark turns it into a query (**VOLTage?**, **VOLTage:PROtection?**). If a query contains a parameter, place the query indicator at the end of the last header (**VOLTage:PROtection?MAX**).

Message unit separator

When two or more message units are combined into a compound message, separate the units with a semicolon (**STATus:OPERation?;QUESTionable?**).

Root specifier

When it precedes the first header of a message unit, the colon becomes the root specifier. It tells the command parser that this is the root or the top node of the command tree.

Message terminator

A terminator informs SCPI that it has reached the end of a message. Three permitted message terminators are:

- newline (<NL>), decimal 10 or hexadecimal 0X0A in ASCII.
- end or identify (<END>)
- both of the above (<NL><END>).

In the examples of this guide, there is an assumed message terminator at the end of each message.

Command execution rules

- Commands execute in the order that they are presented in the program message.
- An invalid command generates an error and, of course, is not executed.
- Valid commands that precede an invalid command in a multiple command program message are executed.
- Valid commands that follow an invalid command in a multiple command program message are ignored.

1.4 Response Data Type

Character strings returned by query statements may take either of the following forms, depending on the length of the returned string:

- **<CRD>**: character response data. Permits the return of character strings.
- **<AARD>**: arbitrary ASCII response data. Permits the return of un delimited 7-bit ASCII. This data type has an implied message terminator.
- **<SRD>**: string response data. Returns string parameters enclosed in double quotes.
- **<Block>**: arbitrary block data.

Response messages

A response message is the message sent by the instrument to the computer in response to a query command.

Sending a response message

After sending a query command, the response message is placed in the Output Queue. When the instrument is then addressed to talk, the response message is sent from the Output Queue to the computer

Multiple response messages

If you send more than one query command in the same program message, the multiple response messages for all the queries is sent to the computer when the instrument is addressed to talk. The responses are sent in the order that the query commands were sent and are separated by semicolons (;). Items within the same query are separated by commas (.). The following example shows the response message for a program message that contains four single item query commands:

```
0; 1; 1; 0
```

Response message terminator (RMT)

Each response is terminated with an LF (line feed) and EOI (end or identify). The following example shows how a multiple response message is terminated:

```
0; 1; 1; 0; <RMT>
```

Message exchange protocol

Two rules summarize the message exchange protocol:

- **Rule 1:** You must always tell the instrument what to send to the computer. The following two steps must always be performed to send information from the instrument other computer:
 1. Send the appropriate query command(s) in a program message.
 2. Address the instrument to talk.
- **Rule 2:** The complete response message must be received by the computer before another program message can be sent to the instrument.

1.5 Command Format

Formats for command display are as follows:

```
[SOURce[1|2]:]VOLTage:UNIT {VPP|VRMS|DBM}
```

```
[SOURce[1|2]:]FREQuency:CENTer  
{<frequency>|MINimum|MAXimum|DEFault}
```

Based on the command syntax, most commands (and certain Parameter) are

expressed in both upper and lower cases. Upper case refers to abbreviation of commands. Shorter program line may send commands in abbreviated format. Long-format commands may be sent to ensure better program readability.

For example, both formats of VOLT and VOLTAGE are acceptable in the above syntax statements. Upper or lower case may be used. Therefore, formats of VOLTAGE, volt and Volt are all acceptable. Other formats (such as VOL and VOLTAG) are invalid and will cause errors.

- Parameter options with given command strings are included in the brace ({}). The brace is not sent along with command strings.
- Vertical stripes (|) separate several parameter options with given command strings. For example, {VPP|VRMS|DBM} indicates that you may assign "APP", "VRMS" or "DBM" in the above commands. Vertical stripes are not sent along with command strings.
- Angle brackets (< >) in the second example indicates that a value must be assigned to the parameter in the brace. For example, the parameter in the angle bracket is <frequency> in the above syntax statements. Angle brackets are not sent along with command strings. You must assign a value (such as "FREQ:CENT 1000") to the parameter, unless you select other options displayed in the syntax (such as "FREQ:CENT MIN").
- Some syntax elements (such as nodes and Parameter) are included in square brackets ([]). It indicates that these elements can be selected and omitted. Angle brackets are not sent along with command strings. If no value is assigned to the optional Parameter, the instrument will select a default value. In the above examples, "SOURce[1|2]" indicates that you may refer to source channel 1 by "SOURce" or "SOURce1" or "SOUR1" or "SOUR". In addition, since the whole SOURce node is optional (in the square bracket), you can refer to the channel 1 by omitting the whole SOURce node. It is because the channel 1 is the default channel for SOURce language node. On the other hand, if you want to refer to channel 2, "SOURce2" or "SOUR2" must be used in the program line.

Colon (:)

It is used to separate key words of a command with the key words in next level. As shown below:

APPL:SIN 455E3,1.15,0.0

In this example, APPLy command assigns a sine wave with frequency of 455 KHz, amplitude of 1.15 V and DC offset of 0.0 V.

Semicolon (;)

It is used to separate several commands in the same subsystem and can also minimize typing. For example, to send the following command string:

TRIG:SOUR EXT; COUNT 10

has the same effect as sending the following two commands:

**TRIG:SOUR EXT
TRIG:COUNT 10**

Question mark (?)

You can insert question marks into a command to query current values of most Parameter. For example, the following commands will trigger to set the count as

10:

TRIG:COUN 10

Then, you may query count value by sending the following command:

TRIG:COUN?

You may also query the allowable minimum or maximum count as follows:

TRIG:COUN?MIN

TRIG:COUN?MAX

Comma (,)

If a command requires several Parameter, then a comma must be used to separate adjacent Parameter.

Space

You must use blank characters, [TAB] or [Space] to separate Parameter with key words of commands.

Common commands (*)

The IEEE-488.2 standard defines a set of common commands that perform functions such as reset, self-test, and status operations. Common commands always start with an asterisk (*) and occupy 3 character sizes, including one or more Parameter. Key words of a command and the first parameter are separated by a space. Semicolon (;) can separate several commands as follows:

***RST; *CLS; *ESE 32; *OPC?**

Command terminator

Command strings sent to the instrument must end with a <Newline> (<NL>) character. IEEE-488 EOI (End or Identify) information can be used as <NL> character to replace termination command string of <NL> character. It is acceptable to place one <NL> after a <Enter>. Termination of command string always resets current SCPI command path to root level.

NOTE

As for every SCPI message with one query sent to the instrument, the instrument will use a <NL> or newline sign (EOI) to terminate response of return. For example, if "DISP:TEXT?" is sent, <NL> will be placed after the returned data string to terminate response. If an SCPI message includes several queries separated by semicolon (such as "DISP?;DISP:TEXT?"), <NL> will terminate response returned after response to the last query. In all cases, the program must read <NL> in response before another command is sent to the instrument, otherwise errors will be caused.

1.6 Data Type

SCPI language defines several data types used for program message and response messages.

- Numerical parameter

Commands requiring numerical parameter support the notations of all

common decimal notations, including optional signs, decimal points, scientific notation, etc. Special values of numerical parameter are also acceptable, such as MIN, MAX and DEF. In addition, suffixes for engineering units can also be sent together with numerical parameter (including M, k, m or u). If the command accepts only some specific values, the instrument will automatically round the input parameter to acceptable values. The following commands require numerical parameter of frequency value:

[SOURce[1|2]:]FREQuency:CENTer
{<Frequency>|MINimum|MAXimum}

- **<NR1>**: represents an integer value, such as 273;
- **<NR2>**: represents a real number in floating-point format, such as .273;
- **<NR3>**: represents a real number in scientific notation, such as 2.73E+2;
- **<Nrf>**: The extensible form includes <NR1>, <NR2> and <NR3>;
- **<Nrf+>**: The extensible decimal form includes <Nrf>, MIN, MAX and DEF. MIN and MAX are the minimum and maximum finite number. Within the range of the parameter definition, DEF is the default of the parameter.

- Discrete parameter

Discrete parameter are used for settings with limited number of programming values (such as IMMEDIATE, EXTERNAL or BUS). They can use short and long format like key words of commands. They may be expressed in both upper and lower case. The query response always returns uppercase Parameter in short format. The following commands require discrete parameter in voltage unit:

[SOURce[1|2]:]VOLTage:UNIT {VPP|VRMS|DBM}

- Boolean parameter

Boolean parameter refer to true or false binary conditions. In case of false conditions, the instrument will accept "OFF" or "0". In case of true conditions, the instrument will accept "ON" or "1". In query of Boolean settings, the instrument will always return "0" or "1". Boolean parameter are required by the following commands:

DISPlay {OFF|0|ON|1}

- ASCII string parameter

String parameter may actually include all ASCII character sets. Character strings must start and end with paired quotation marks; and single quotation marks or double quotation marks are both allowed. Quotation mark separators may also act as one part of a string, they can be typed twice without any character added between them. String parameter is used in the following command:

DISPlay:TEXT <quoted string>

For example, the following commands display message of "WAITING..." (without quotation marks) on the front panel of the instrument.

DISP:TEXT "WAITING..."

Single quotation marks may also be used to display the same message.

DISP:TEXT 'WAITING...'

- **<SPD>**: string program data. String parameters enclosed in single or double quotes.
- **<CPD>**: character program data.

1.7 Remote Interface Connections

Please refer to user manual for detailed introductions of the remote interface.

**Note**

If the user want to change the settings of the instrument, for instance, the output setting value, the command SYST:REM must be sent to the instrument after finishing the connection between the instrument and PC.

Chapter2 Status register

You can get the current status of the power supply by reading the status registers. The power supply records the different status of the instrument through the four status register group. The four status register groups are: Questionable Status Register, Operation Status Register, Standard Event Register and Status Byte Register. Status Byte Register records the information of the other status register.

The following table describes the status signals.

Bit name	Bit	Decimal value	Definition
Questionable Status Register			
OV	0	1	Output is disabled by the over-voltage protection.
OC	1	2	Output is disabled by the over-current protection.
OP	2	4	Output is disabled by the over-power protection.
UV	3	8	Output is disabled by the under-voltage protection.
OT	4	16	Output is disabled by the over-temperature protection.
UC	5	32	Output is disabled by the under-current protection.
SRvs	6	64	Sense malfunction.
Foldback	7	128	Foldback protection.
Focp	8	256	Over current protection of front panel.
Fucp	9	512	Under current protection of front panel.
AC-DOWN	10	1024	Power down protection.
PFC	11	2048	PFC protection.
Bridge	12	4096	Half-Bridge protection.
WDOG	13	8192	Watchdog protection.
Operation Status Register			
Cal	1	2	The power supply is under calibration.
List	2	4	The power supply is running the list program.
WTG	3	8	The power supply is waiting for a trigger.
CV	4	16	Output is in constant voltage.
CC	5	32	Output is in constant current.
On_Delay	7	128	The power supply is in the output-on delay.
Off_Delay	8	256	The power supply is in the output-off delay.

On	9	512	Output is programmed on.
Standard Event Register			
OPC	0	1	All commands before and including *OPC have been executed.
QYE	2	4	The instrument tried to read the output buffer but it was empty, a new command line was received before a previous query has been read, or both the input and output buffers are full.
DDE	3	8	A device-specific error, including a self-test error, calibration error or other device-specific error occurred.
EXE	4	16	An execution error occurred.
CME	5	32	A command syntax error occurred.
NU	6	not used	0 is returned.
PON	7	128	Power has been cycled since the last time the event register was read or cleared.
Status Byte Register			
NU	0	not used	0 is returned.
NU	1	not used	0 is returned.
EAV	2	4	Error buffer available.
QUES	3	8	This bit is set to 1 when any one status of enabled query status register changes.
MAV	4	16	Output buffer available.
ESB	5	32	Bit ESB is set to 1 when the status of an enabled standard event status.
RQS/MSS	6	64	Register changes.
OPER	7	128	If the status of enabled operation register changes, then this bit is set to 1.

The following figure shows the status register structure of the power supply.

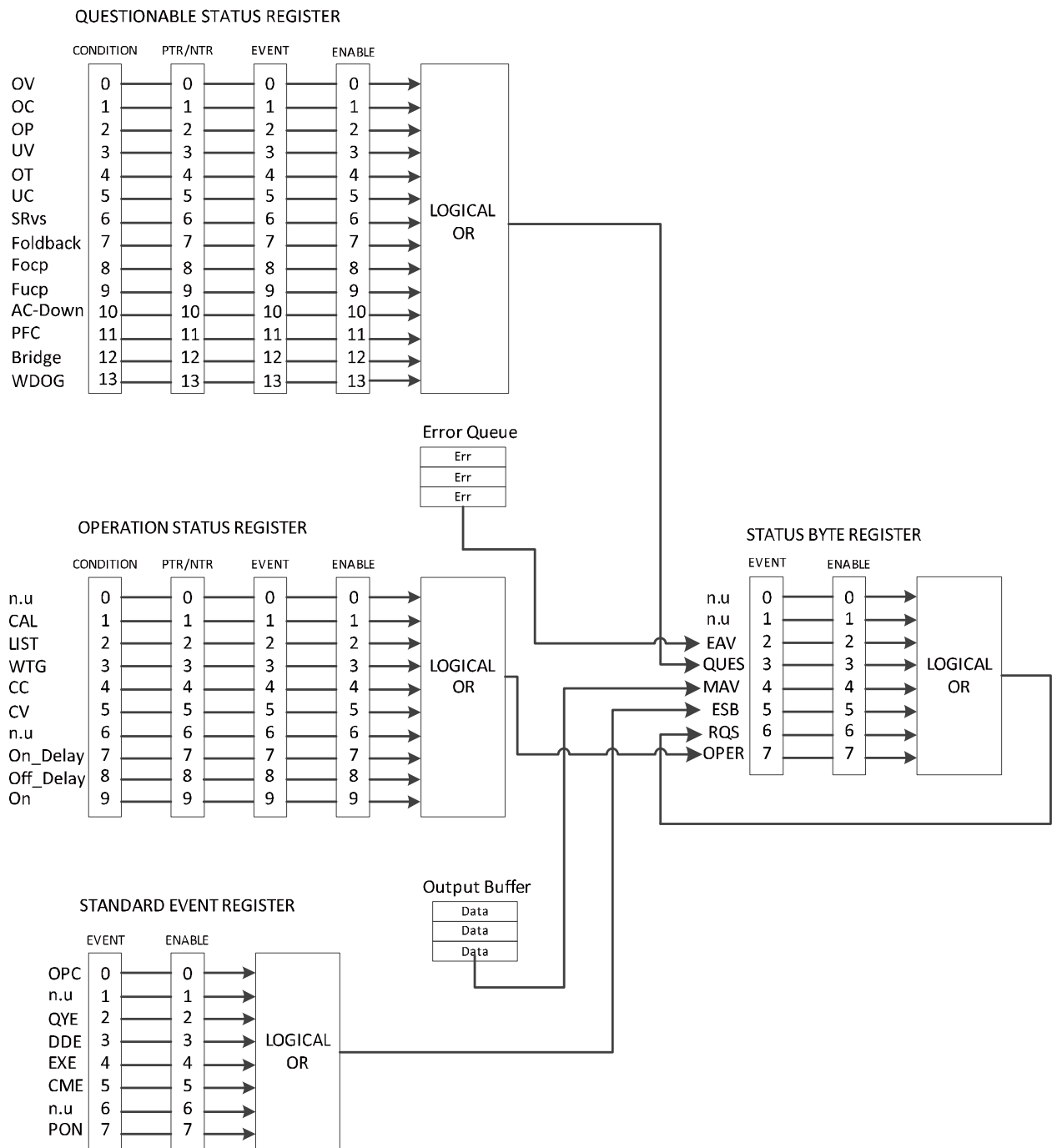

Chapter3 Output Commands

OUTPut[:STATe] <bool>

This command sets the output state of the power supply.

Syntax

OUTPut[:STATe] <bool>

Arguments

0|OFF|1|ON

Default value

0

Example

OUTP ON

Query command

OUTPut[:STATe]?

Returns

0|1

[OUTPut:]PROTection:CLEAr

This command clears the protection status.

Syntax

[OUTPut:]PROTection:CLEAr

Arguments

None

Default value

Not applicable

Example

PROT:CLE

Query command

None

Returns

None

OUTPut:DELaY[:ON] <NRf+>

This command sets the delay time before turning the output on.

Syntax

OUTPut:DELaY[:ON] <NRf+>

Arguments

<0.000-10.000>

Default value

0.000S

Example

OUTP:DEL 1.0

Query command

OUTPut:DELaY[:ON]? [MINimum|MAXimum]

Returns

NR2

OUTPut:DELaY:OFF <NRf+>

This command sets the delay time after turning the output off.

Syntax

OUTPut:DELaY:OFF <NRf+>

Arguments

<0.000-10.000>

Default value

0.000S

Example

OUTP:DEL:OFF 1.0

Query command

OUTPut:DELaY:OFF? [MINimum|MAXimum]

Returns

NR2

OUTPut:TIMer[:STATe] <bool>

This command sets the output timer state of the power supply.

Syntax

OUTPut:TIMer[:STATe] <bool>

Arguments

0|OFF|1|ON

Default value

0

Example

OUTP:TIM OFF

Query command

OUTP:TIMer?

Returns

0|1

OUTPut:TIMer:DATA <NRf+>

This command sets time of the output timer.

Syntax

OUTPut:TIMer:DATA <NRf+>

Arguments

< 1.0-86400.0>

Default value

1.0s

Example

OUTP:TIM:DATA 3600.0

Query command

OUTPut:TIMer:DATA? [MINimum|MAXimum]

Returns

NR3

OUTPut:TIMer:DELay <NRf+>

This command sets time delay of the output timer.

Syntax

OUTPut:TIMer:DELay <NRf+>

Arguments

< 1.0-86400.0>

Default value

1.0s

Example

OUTP:TIM:DEL 3600

Query command

OUTPut:TIMer:DELay? [MINimum|MAXimum]

Returns

NR2

OUTPut:PROTection:FOLDback[:MODE] <OFF|CC|CV>

This command sets the foldback protection mode.

Syntax

OUTPut:PROTection:FOLDback[:MODE] <OFF|CC|CV>

Arguments

<CPD>

OFF|CC|CV

Default value

OFF

Example

OUTP:PROT:FOLD CC

Query command

`OUTPut:PROTection:FOLDback[:MODE]?`

Returns

`OFF|CC|CV`**OUTPut:PROTection:FOLDback:DELay <NRf+>**

This command sets the delay time of the foldback mode.

Syntax

`OUTPut:PROTection:FOLDback:DELay <NRf+>`

Arguments

`<NRf+>``<0.0000-30.0000>`

Default value

`0.0000`

Example

`OUTP:PROT:FOLD:DEL 1`

Query command

`OUTPut:PROTection:FOLDback:DELay? [MINimum|MAXimum]`

Returns

`NR2`**OUTPut:INHibit:MODE <CPD>**

Set the inhibit output mode of external LOCK IO.

Syntax

`OUTPut:INHibit:MODE <CPD>`

Arguments

`LIVE|LATChing`

Default value

`LIVE`

Example

`OUTP:INH:MODE LIVE`

Query command

`OUTPut:INHibit:MODE?`

Returns

`LIVE|LATChing`**OUTPut:INHibit:POLarity <CPD>**

Set the enable polarity of the external Lock IO.

Syntax

`OUTPut:INHibit:POLarity <CPD>`

Arguments

`NORMal|INVerted`

Default value

`NORMal`

Example

`OUTPut:INHibit:POLarity NORMal`

Query command

`OUTPut:INHibit:POLarity?`

Returns

`NORMal|INVerted`**[OUTPut:]PROTection:WDOG[:STATe] <Bool>**

This command enables or disables the state of the communication watchdog.

Syntax

`[OUTPut:]PROTection:WDOG[:STATe] <Bool>`

Arguments

`0|OFF|1|ON`

Arguments

`0`

Example

```
OUTP:PROT:WDOG ON
```

Query command

```
[OUTPut:]PROTection:WDOG[:STATe]?
```

Returns

```
0|1
```

**OUTPut:PROTection:WDOG:DELay
[MINimum|MAXimum]**

This command sets the time of the communication watchdog.

Syntax

```
OUTPut:PROTection:WDOG:DELay [MINimum|MAXimum]
```

Arguments

```
<NRf+> 2.0-3600.0
```

Default value

```
2.0s
```

Example

```
OUTP:PROT:WDOG:DEL 2.0
```

Query command

```
[OUTPut:]PROTection:WDOG:DELay? [MINimum|MAXimum]
```

Returns

```
NR2
```

Chapter4 Measurement Commands

MEASure[:SCALar]:CURRent[:DC]?

This command queries the current reading.

Syntax

MEASure[:SCALar]:CURRent[:DC]?

Arguments

None

Default value

Not applicable

Example

MEAS:CURR?

Returns

NRf

FETCh[:SCALar]:CURRent[:DC]?

This command reads the latest current to be processed from sampling buffer.

Syntax

FETCh[:SCALar]:CURRent[:DC]?

Arguments

None

Default value

Not applicable

Example

FETC:CURR?

Returns

NRf

MEASure[:SCALar]:POWer[:DC]?

This command queries the present power measurement.

Syntax`MEASure[:SCALar]:POWer[:DC]?`**Arguments**

None

Default value

Not applicable

Example`MEAS:POW?`**Returns**

NRf

FETCh[:SCALar]:POWer[:DC]?

This command reads the latest power value from the sampling buffer..

Syntax`FETCh[:SCALar]:POWer[:DC]?`**Arguments**

None

Default value

Not applicable

Example`FETC:POW?`**Returns**

NRf

MEASure[:SCALar]:VOLTage[:DC]?

This command queries the newly measured voltage.

Syntax`MEASure[:SCALar]:VOLTage[:DC]?`**Arguments**

None

Default value

Not applicable

Example

MEAS:VOLT?

Returns

NRf

FETCh[:SCALar]:VOLTage[:DC]?

This command reads the latest preprocessed voltage value from sampling buffer.

Syntax

FETCh[:SCALar]:VOLTage[:DC]?

Arguments

None

Default value

Not applicable

Example

FETC:VOLT?

Returns

NRf

MEASure:ALL?

This command queries the present voltage measurement, current measurement and power measurement

Syntax

MEASure:ALL?

Arguments

None

Default value

Not applicable

Example

MEAS:ALL?

Returns

NRf,NRf,NRf

FETCh:ALL?

This command reads the latest preprocessed capacity voltage value, current value and power value from sampling buffer.

Syntax

FETCh:ALL?

Arguments

None

Default value

Not applicable

Example

FETC:ALL?

Returns

NRf,NRf,NRf

FETCh:TIME?

This command queries the output time when the timer starts.

Syntax

FETCh:TIME?

Arguments

None

Default value

Not applicable

Example

FETC:TIME?

Returns

NRf

Chapter5 Sense Commands

SENSe[:REMOte][:STATe] <bool>

This command enables or disables the sense function.

Syntax

SENSe[:REMOte][:STATe] <bool>

Arguments

0|OFF|1|ON

Default value

0

Example

SENS ON

Query command

SENSe[:REMOte][:STATe]?

Returns

0|1

SENSe:FILTer:LEVel <SLOW|MEDIum|FAST>

This command sets the sense filter level.

Syntax

SENSe:FILTer:LEVel <SLOW|MEDIum|FAST>

Arguments

<CPD>

SLOW|MEDIum|FAST

Default value

Not applicable

Example

SENS:FILT:LEV MED

Query command

`SENSe:FILTer:LEVel?`

Returns

`SLOW|MEDIum|FAST`

Chapter6 Source Commands

[SOURce:]CURRent[:LEVel][:IMMediate][:AMPLitude] <NRf+>

This command sets the current value of the power supply. The query form of this command gets the set current value of the power supply.

Syntax

[SOURce:]CURRent[:LEVel][:IMMediate][:AMPLitude] <NRf+>

Arguments

<NRf+>

Default value

0.1

Example

CURR 3.500

Query command

[SOURce:]CURRent[:LEVel][:IMMediate][:AMPLitude]? [MINimum|MAXimum]

Returns

NR2

[SOURce:]CURRent[:LEVel]:TRIGgered[:AMPLitude] <NRf+>

This command sets the output current value when the power supply receives a trigger.

Syntax

[SOURce:]CURRent[:LEVel]:TRIGgered[:AMPLitude] <NRf+>

Arguments

<NRf+>

Default value

0.100

Example

CURR:TRIG 3.500

Query command

[SOURce:]CURRent[:LEVel]:TRIGgered[:AMPLitude]? [MINimum|MAXimum]

Returns

NR2

**[SOURce:]CURRent[:OVER]:PROTection[:LEVel]
<NRf+>**

This command sets the over-current limit of the power supply.

Syntax

[SOURce:]CURRent[:OVER]:PROTection[:LEVel] <NRf+>

Arguments

<NRf+>

Default value

RANGe

Example

CURR:PROT 3.500

Query command

[SOURce:]CURRent[:OVER]:PROTection[:LEVel]? [MINimum|MAXimum]

Returns

NR2

**[SOURce:]CURRent[:OVER]:PROTection:DELAy
<NRf+>**

This command sets the over-current delay time of the power supply.

Syntax

[SOURce:]CURRent[:OVER]:PROTection:DELAy <NRf+>

Arguments

<NRF+>

<0.00-10.00>

Default value

RANGe

Example

```
CURR:PROT:DEL 10.00
```

Query command

```
[SOURce:]CURRent[:OVER]:PROTection:DELay? [MINimum|MAXimum]
```

Returns

```
NR2
```

**[SOURce:]CURRent[:OVER]:PROTection:STATe
<bool>**

This command enables or disables the over-current function.

Syntax

```
[SOURce:]CURRent[:OVER]:PROTection:STATe <bool>
```

Arguments

```
0|OFF|1|ON
```

Default value

```
0
```

Example

```
CURR:PROT:STAT ON
```

Query command

```
[SOURce:]CURRent[:OVER]:PROTection:STATe?
```

Returns

```
0|1
```

**[SOURce:]CURRent:UNDer:PROTection[:LEVel]
<NRf+>**

This command sets the under-current limit of the power supply.

Syntax

```
[SOURce:]CURRent:UNDer:PROTection[:LEVel] <NRf+>
```

Arguments

```
<NRf+>
```

Default value

0.000

Example

CURR:UND:PROT 0.500

Query command

[SOURce:]CURRent:UNDer:PROTection[:LEVel]? [MINimum|MAXimum]

Returns

<NR2>

**[SOURce:]CURRent:UNDer:PROTection:DELay
<NRf+>**

This command sets the under-current delay time of the power supply.

Syntax

[SOURce:]CURRent:UNDer:PROTection:DELay <NRf+>

Arguments

<NRF+>

<0.00-10.00>

Default value

10.00S

Example

CURR:UND:PROT:DEL 10.000

Query command

[SOURce:]CURRent:UNDer:PROTection:DELay? [MINimum|MAXimum]

Returns

<NR2>

[SOURce:]CURRent:UNDer:PROTection:STATE <bool>

This command enables or disables the under-current function.

Syntax

[SOURce:]CURRent:UNDer:PROTection:STATE <bool>

Arguments

<0|OFF|1|ON>

Default value

0

Example

CURR:UND:PROT:STAT ON

Query command

[SOURce:]CURRent:UNDer:PROTection:STATe?

Returns

0|1

[SOURce:]CURRent:UNDer:PROTection:WARM <NRf+>

This command sets the under-current warm-up time of the power supply.

Syntax

[SOURce:]CURRent:UNDer:PROTection:WARM <NRf+>

Arguments

<0.00-30.00>

Default value

30.00S

Example

CURR:UND:PROT:WARM 10.000

Query command

[SOURce:]CURRent:UNDer:PROTection:WARM? [MINimum|MAXimum]

Returns

NR2

[SOURce:]CURRent:SLEW[:BOTH] <NRf+>

This command sets the current rising and falling slew rate of the power supply.

Syntax

[SOURce:]CURRent:SLEW[:BOTH] <NRf+>

Arguments

<0.001-3600.0>

Example

CURR:SLEW 0.030

Query command

None

Returns

None

[SOURce:]CURRENT:SLEW:NEGative <NRf+>

This command sets the current falling slew rate of the power supply.

Syntax

[SOURce:]CURRENT:SLEW:NEGative <NRf+>

Arguments

<0.001-3600.0>

Default value

0.1

Example

CURR:SLEW:NEG 1.000

Query command

[SOURce:]CURRENT:SLEW:NEGative? [MINimum]MAXimum]

Returns

NR2

[SOURce:]CURRENT:SLEW:POSitive <NRf+>

This command sets the current rising slew rate of the power supply.

Syntax

[SOURce:]CURRENT:SLEW:POSitive <NRf+>

Arguments

<0.001-3600.0>

Default value

0.1

Example

CURR:SLEW:POS 1.000

Query command

[SOURce:]CURRent:SLEW:POSitive? [MINimum|MAXimum]

Returns

NR2

**[SOURce:]VOLTage[:LEVel][:IMMediate][:AMPLitude]
<NRf+>**

This command sets the voltage value of the power supply. The query form of this command gets the set voltage value of the power supply.

Syntax

[SOURce:]VOLTage[:LEVel][:IMMediate][:AMPLitude] <NRf+>

Arguments

<NRf+>

Default value

0.00

Example

VOLT 60.00

Query command

[SOURce:]VOLTage[:LEVel][:IMMediate][:AMPLitude]? [MINimum|MAXimum]

Returns

NR2

**[SOURce:]VOLTage[:LEVel]:TRIGgered[:AMPLitude]
<NRf+>**

This command sets the output voltage value when the power supply receives a trigger.

Syntax

[SOURce:]VOLTage[:LEVel]:TRIGgered[:AMPLitude] <NRf+>

Arguments

<NRf+>

Default value

0.00

Example

VOLT:TRIG 10.00

Query command

[SOURce:]VOLTage[:LEVel]:TRIGgered[:AMPLitude]? [MINimum|MAXimum]

Returns

NR2

[SOURce:]VOLTage:SLEW[:BOTH] <NRf+>

This command sets the voltage rising and falling slew rate of the power supply.

Syntax

[SOURce:]VOLTage:SLEW[:BOTH] <NRf+>

Arguments

<0.001-3600.0>

Example

VOLT:SLEW 0.03

Query command

None

Returns

None

[SOURce:]VOLTage:SLEW:NEGative <NRf+>

This command sets the voltage falling slew rate of the power supply.

Syntax

[SOURce:]VOLTage:SLEW:NEGative <NRf+>

Arguments

<0.001-3600.0>

Default value

0.1

Example

VOLT:SLEW:NEG 0.03

Query command

[SOURce:]VOLTage:SLEW:NEGative? [MINimum|MAXimum]

Returns

NR2

[SOURce:]VOLTage:SLEW:POSitive <NRf+>

This command sets the voltage rising slew rate of the power supply.

Syntax

[SOURce:]VOLTage:SLEW:POSitive <NRf+>

Arguments

<0.001-3600.0>

Default value

0.1

Example

VOLT:SLEW:POS 0.03

Query command

[SOURce:]VOLTage:SLEW:POSitive? [MINimum|MAXimum]

Returns

NR2

**[SOURce:]VOLTage[:OVER]:PROTection[:LEVel]
<NRf+>**

This command sets the over-voltage limit of the power supply.

Syntax

[SOURce:]VOLTage[:OVER]:PROTection[:LEVel] <NRf+>

Arguments

<NRf+>

Default value

MAX

Example

VOLT:PROT 600.00

Query command

[SOURce:]VOLTage[:OVER]:PROTection[:LEVel]? [MINimum|MAXimum]

Returns

NR2

**[SOURce:]VOLTage[:OVER]:PROTection:DELay
<NRf+>**

This command sets the over-voltage delay time of the power supply.

Syntax

[SOURce:]VOLTage[:OVER]:PROTection:DELay <NRf+>

Arguments

<0.00-10.00>

Default value

10.00S

Example

VOLT:PROT:DEL 10.00

Query command

[SOURce:]VOLTage[:OVER]:PROTection:DELay? [MINimum|MAXimum]

Returns

NR2

**[SOURce:]VOLTage[:OVER]:PROTection:STATe
<bool>**

This command enables or disables the over-voltage function.

Syntax

[SOURce:]VOLTage[:OVER]:PROTection:STATe <bool>

Arguments

0|OFF|1|ON

Default value

0

Example

VOLT:PROT:STAT ON

Query command

[SOURce:]VOLTage[:OVER]:PROTection:STATe?

Returns

0|1

**[SOURce:]VOLTage:UNDer:PROTection[:LEVel]
<NRf+>**

This command sets the under-voltage limit of the power supply.

Syntax

[SOURce:]VOLTage:UNDer:PROTection[:LEVel] <NRf+>

Arguments

<NRf+>

Default value

0.00

Example

VOLT:UND:PROT 10.00

Query command

[SOURce:]VOLTage:UNDer:PROTection[:LEVel]? [MINimum|MAXimum]

Returns

NR2

**[SOURce:]VOLTage:UNDer:PROTection:DELay
<NRf+>**

This command sets the under-voltage delay time of the power supply.

Syntax

```
[SOURce:]VOLTage:UNDer:PROTection:DELay <NRf+>
```

Arguments

```
<0.00-10.00>
```

Default value

```
10.00S
```

Example

```
VOLT:UND:PROT:DEL 10.00
```

Query command

```
[SOURce:]VOLTage:UNDer:PROTection:DELay? [MINimum|MAXimum]
```

Returns

```
NR2
```

[SOURce:]VOLTage:UNDer:PROTection:STATE <bool>

This command enables or disables the under-voltage function.

Syntax

```
[SOURce:]VOLTage:UNDer:PROTection:STATE <bool>
```

Arguments

```
0|OFF|1|ON
```

Default value

```
0
```

Example

```
VOLT:UND:PROT:STAT ON
```

Query command

```
[SOURce:]VOLTage:UNDer:PROTection:STATE?
```

Returns

```
0|1
```

**[SOURce:]VOLTage:UNDer:PROTection:WARM
<NRf+>**

This command sets the under-voltage warm-up time of the power supply.

Syntax

```
[SOURce:]VOLTage:UNDer:PROTection:WARM <NRf+>
```

Arguments

```
<0.00-30.00>
```

Default value

```
30.00S
```

Example

```
VOLT:UND:PROT:WARM 10.00
```

Query command

```
[SOURce:]VOLTage:UNDer:PROTection:WARM? [MINimum|MAXimum]
```

Returns

```
NR2
```

[SOURce:]VOLTage[:LEVel]:LIMit[:HIGH] <NRf+>

This command sets the maximum setting voltage limit of the power supply.

Syntax

```
[SOURce:]VOLTage[:LEVel]:LIMit[:HIGH] <NRf+>
```

Arguments

```
<NRf+>
```

Default value

```
MAX
```

Example

```
VOLT:LIM 500.00
```

Query command

```
[SOURce:]VOLTage[:LEVel]:LIMit[:HIGH]? [MINimum|MAXimum]
```

Returns

```
<NR2>
```

[SOURce:]VOLTage[:LEVel]:LIMit:LOW <NRf+>

This command sets the minimum setting voltage limit of the power supply.

Syntax

```
[SOURce:]VOLTage[:LEVel]:LIMit:LOW <NRf+>
```

Arguments

```
<NRf+>
```

Default value

```
0.00
```

Example

```
VOLT:LIM:LOW 10.00
```

Query command

```
[SOURce:]VOLTage[:LEVel]:LIMit:LOW? [MINimum|MAXimum]
```

Returns

```
<NR2>
```

[SOURce:]POWER[:LEVel][:IMMediate][:AMPLitude] <NRf+>

This command sets the maximum power value of the power supply. The query form of this command gets the power value of the power supply.

Syntax

```
[SOURce:]POWER[:LEVel][:IMMediate][:AMPLitude] <NRf+>
```

Arguments

```
<NRf+>
```

Default value

```
MAX
```

Example

```
POW 100.0
```

Query command

```
[SOURce:]POWER[:LEVel][:IMMediate][:AMPLitude]? [MINimum|MAXimum]
```

Returns

```
NR2
```

[SOURce:]POWER:PROTection[:LEVel] <NRf+>

This command sets the over-power limit of the power supply.

Syntax

```
[SOURce:]POWer:PROTection[:LEVel] <NRf+>
```

Arguments

```
<NRf+>
```

Default value

```
MAX
```

Example

```
POW:PROT 100.0
```

Query command

```
[SOURce:]POWer:PROTection[:LEVel]? [MINimum|MAXimum]
```

Returns

```
NR2
```

[SOURce:]POWer:PROTection:DELaY <NRf+>

This command sets the over-power delay time of the power supply.

Syntax

```
[SOURce:]POWer:PROTection:DELaY <NRf+>
```

Arguments

```
<0.00-10.00>
```

Default value

```
10.00S
```

Example

```
POW:PROT:DEL 10.00
```

Query command

```
[SOURce:]POWer:PROTection:DELaY? [MINimum|MAXimum]
```

Returns

```
NR2
```

[SOURce:]POWer:PROTection:STaTe <Bool>

This command enables or disables the over-power function.

Syntax`[SOURce:]POWer:PROTection:STATe <Bool>`**Arguments**`0|OFF|1|ON`**Default value**`0`**Example**`POW:PROT:STAT ON`**Query command**`[SOURce:]POWer:PROTection:STATe?`**Returns**`0|1`**[SOURce:]FUNCTION:MODE <CPD>**

This command sets the operating modes of the power supply.

Syntax`[SOURce:]FUNCTion:MODE <CPD>`**Arguments**`<CPD>``<FIXed|LIST >`**Default value**`FIXed`**Example**`FUNC:MODE LIST`**Query command**`[SOURce:]FUNCTion:MODE?`**Returns**`FIXed|LIST`**[SOURce:]FUNCTION:PRIority <CPD>**

This command sets the priority mode of the power supply.

Syntax

[SOURce:]FUNCtion:PRiority <CPD>

Arguments

<CPD>

<VOLTage|CURRent>

Default value

VOLTage

Example

FUNC:PRI VOLT

Query command

[SOURce:]FUNCtion:PRiority?

Returns

VOLTage|CURRent

[SOURce:]APPLY <NRf+>,<NRf+>

This command sets voltage and current values with a single command message

Syntax

[SOURce:]APPLY <NRf+>,<NRf+>

Arguments

<NRf+> voltage value <0.00-MAX>

<NRf+> current value <0.000-MAX>

Default value

0,0.1

Example

APPL 10.00,3.500

Query command

[SOURce:]APPLY?

Returns

NR2,NR2

[SOURce:]EXTErnal[:PROGrama] [:STATe] <bool>

This command enables or disables the external analog quantity function of the power supply.

Syntax

```
[SOURce:]EXTErnal[:PROGrama] [:STATe] <bool>
```

Arguments

```
0|OFF|1|ON
```

Default value

```
0
```

Example

```
EXT ON
```

Query command

```
[SOURce:]EXTErnal[:STATe]?
```

Returns

```
0|1
```

[SOURce:]BLEeder[:STATe]

This command enables or disables the bleeder circuit function.

Syntax

```
[SOURce:]BLEeder[:STATe] <bool>
```

Arguments

```
0|OFF|1|ON
```

Default value

```
Not applicable
```

Example

```
BLE ON
```

Query command

```
[SOURce:]BLEeder[:STATe]?
```

Returns

```
0|1
```

[SOURce:]EXTErnal[:PROGrama][:CHANnel]:MX <NR1>,<NRf+>

This command is used to set the linear calibration coefficient of the channel (1/2). The instruction needs to set two parameters, separated by commas, the channel number in front of the comma, and the linear calibration coefficient after the comma.

Syntax

```
[SOURce:]EXTErnal[:PROGrama][:CHANnel]:MX <NR1>,<NRf+>
```

Arguments

- <NR1>
Settings: 1,2
- <NRf+>
Value range: MIN (-999.9) ~MAX (999.9)

Default value

DEF

Example

```
EXT:MX 1,10
```

Query command

```
[SOURce:]EXTErnal[:PROGrama][:CHANnel]:MX? <NR1>
```

Returns

```
<NRf>
```

[SOURce:]EXTErnal[:PROGrama][:CHANnel]:MB <NR1>,<NRf+>

This command is used to set the offset calibration coefficient of the channel (1/2). The instruction needs to set two parameters, separated by commas, the channel number in front of the comma, and the offset calibration coefficient after the comma.

Syntax

```
[SOURce:]EXTErnal[:PROGrama][:CHANnel]:MB <NR1>,<NRf+>
```

Arguments

- <NR1>
Settings: 1,2

- <NRf+>

Value range: MIN (-999.9) ~MAX (999.9)

Default value

DEF

Example

EXT:MB 1,10

Query command

[SOURce:]EXTErnal[:PROGram][:CHANnel]:MB? <NR1>

Returns

<NRf>

[SOURce:]RESistance[:LEVel][:IMMediate][:AMPLitude] <NRf+>

This command is used to set the internal resistance of the power supply in CV priority mode. Only used in CV priority mode.

Syntax

[SOURce:]RESistance[:LEVel][:IMMediate][:AMPLitude] <NRf+>

Arguments

<NRf+>

<0-3>

Default value

0

Example

RES 1

Query command

[SOURce:]RESistance[:LEVel][:IMMediate][:AMPLitude]?

Returns

<NR2>

Chapter7 System Commands

SYSTem:BEEPer:IMMediate

This command tests the beeper function of the power supply. If it passes the test, a beep is issued.

Syntax

SYSTem:BEEPer:IMMediate

Arguments

None

Default value

Not applicable

Example

SYST:BEEP:IMM

Query command

None

Returns

None

SYSTem:BEEPer[:STATe] <bool>

This command enables or disables the beeper function of the power supply.

Syntax

SYSTem:BEEPer[:STATe] <bool>

Arguments

0|OFF|1|ON

Default value

Not applicable

Example

SYST:BEEP 1

Query command

SYSTem:BEEPer[:STATe]?

Returns

0|1

SYSTem:VERSion?

This command queries the SCPI version of the instrument.

Syntax

SYSTem:VERSion?

Arguments

None

Default value

Not applicable

Example

SYST:VERS?

Returns

AARD

SYSTem:ERRor?

This command reads the error code and error information.

Syntax

SYSTem:ERRor?

Arguments

None

Default value

Not applicable

Example

SYST:ERR?

Returns

AARD

SYSTem:REMOte

This command takes the instrument out of front-panel control mode and switches it to remote control mode.

Syntax

SYSTem:REMOte

Arguments

None

Default value

Not applicable

Example

SYST:REM

Query command

None

Returns

None

SYSTem:LOCAl

This command is to switch the power supply into control from the front panel.

Syntax

SYSTem:LOCAl

Arguments

None

Default value

Not applicable

Example

SYST:LOC

Query command

None

Returns

None

SYSTem:RWLock

This command locks the power supply in remote control mode. When this command is executed, pressing the LOCAL button does not switch the instrument to local control mode.

Syntax

SYSTem:RWLock

Arguments

None

Default value

Not applicable

Example

SYST:RWL

Query command

None

Returns

None

SYSTem:KEY <NR1>

This command and its query form set and read the value of the Operation Enable register.

Syntax

SYSTem:KEY < NR1>

Arguments

0-255

Default value

Not applicable

Example

SYST:KEY 1

Query command

SYSTem:KEY?

Returns

NR1

SYSTem:REBoot

This command is used to perform a device reboot.

Syntax

SYSTem:REBoot

Arguments

None

Default value

Not applicable

Example

SYST:REB

Query command

None

Returns

None

SYSTem:COMMunicate:GPIB[:SELF]:ADDRess <NR1>

This command sets the GPIB address of the power supply.

Syntax

SYSTem:COMMunicate:GPIB[:SELF]:ADDRess <NR1>

Arguments

NR1

<0-30>

Default value

Not applicable

Example

SYST:COMM:GPIB:ADDR 14

Query command

SYSTem:COMMunicate:GPIB[:SELF]:ADDRess?

Returns

NR1

0-30

SYSTem:COMMunicate:LAN:CURRent:ADDRess <SPD>

This command sets the IP address of the power supply.

Syntax

SYSTem:COMMunicate:LAN:CURRent:ADDRess <SPD>

Arguments

"<0-255>,<0-255>,<0-255>,<0-255>"

Default value

Not applicable

Example

SYST:COMM:LAN:CURR:ADDR "192.168.0.201"

Query command

SYSTem:COMMunicate:LAN:CURRent:ADDRess?

Returns

<SRD>

SYSTem:COMMunicate:LAN:CURRent:DGATeway <SPD>

This command sets the gateway of the power supply.

Syntax

SYSTem:COMMunicate:LAN:CURRent:DGATeway <SPD>

Arguments

"<0-255>,<0-255>,<0-255>,<0-255>"

Default value

Not applicable

Example

SYST:COMM:LAN:CURR:DGAT "192.168.0.1"

Query command

SYSTem:COMMunicate:LAN:CURRent:DGATeway?

Returns

<SRD>

SYSTem:COMMunicate:LAN:CURRent:SMASk <SPD>

This command sets the subnet mask of the power supply.

Syntax

SYSTem:COMMunicate:LAN:CURRent:SMASk <SPD>

Arguments

"<0-255>,<0-255>,<0-255>,<0-255>"

Default value

Not applicable

Example

SYST:COMM:LAN:CURR:SMAS "255.255.255.0"

Query command

SYSTem:COMMunicate:LAN:CURRent:SMASk?

Returns

<SRD>

SYSTem:COMMunicate:LAN:DHCP <bool>

This command enables or disables the dynamic IP address function.

Syntax

SYSTem:COMMunicate:LAN:DHCP <bool>

Arguments

<0|OFF|1|ON>

Default value

Not applicable

Example

SYST:COMM:LAN:DHCP 1

Query command

SYSTem:COMMunicate:LAN:DHCP?

Returns

0|1

SYSTem:COMMunicate:LAN:SOCKetport <NR1>

This command sets the socket port for the LAN communication.

Syntax

SYSTem:COMMunicate:LAN:SOCKetport <NR1>

Arguments

<2000 to 65535>

Default value

Not applicable

Example

SYST:COMM:LAN:SOCK 30000

Query command

SYSTem:COMMunicate:LAN:SOCKetport?

Returns

NR1

SYSTem:COMMunicate:LAN:MACaddress?

This command queries the communication MAC address.

Syntax

SYSTem:COMMunicate:LAN:MACaddress?

Arguments

None

Default value

Not applicable

Example

SYST:COMM:LAN:MAC?

Returns

SRD

SYSTem:COMMunicate:SERial:BAUDrate <CPD>

This command sets the baud rate of the serial port.

Syntax

SYSTem:COMMunicate:SERial:BAUDrate <CPD>

Arguments

<4800|9600|19200|38400|57600|115200>

Default value

Not applicable

Example

SYST:COMM:SER:BAUD 9600

Query command

SYSTem:COMMunicate:SERial:BAUDrate?

Returns

4800|9600|19200|38400|57600|115200

SYSTem:COMMunicate:LAN:DNS1 <SPD>

This command sets DNS primary address for LAN.

Syntax

SYSTem:COMMunicate:LAN:DNS1 <SPD>

Arguments

"<0-255>,<0-255>,<0-255>,<0-255>"

Default value

Not applicable

Example

SYST:COMM:LAN:DNS1 "192.168.0.1"

Query command

SYSTem:COMMunicate:LAN:DNS1?

Returns

<SRD>

SYSTem:COMMunicate:LAN:DNS2 <SPD>

This command sets DNS secondary address for LAN.

Syntax

SYSTem:COMMunicate:LAN:DNS2 <SPD>

Arguments

"<0-255>,<0-255>,<0-255>,<0-255>"

Default value

Not applicable

Example

SYST:COMM:LAN:DNS1 "192.168.0.2"

Query command

SYSTem:COMMunicate:LAN:DNS2?

Returns

<SRD>

SYSTem:COMMunicate:LAN:RESTore

This command resets the LAN settings to default settings.

Syntax

SYSTem:COMMunicate:LAN:RESTore

Arguments

None

Default value

Not applicable

Example

SYST:COMM:LAN:REST

Query command

None

Returns

None

SYSTem:COMMunicate:LAN:SAVE

This command makes the LAN settings valid.

Syntax

SYSTem:COMMunicate:LAN:SAVE

Arguments

None

Default value

Not applicable

Example

SYST:COMM:LAN:SAVE

Query command

None

Returns

None

SYSTem:COMMunicate:LAN:STATe?

This command queries the LAN state.

Syntax

SYSTem:COMMunicate:LAN:STATe?

Arguments

None

Default value

Not applicable

Example

SYST:COMM:LAN:STAT?

Returns

DOWN|UP

SYSTem:COMMunicate:LAN:HOSTname?

This command queries the host name in the LAN communication.

Syntax

SYSTem:COMMunicate:LAN:HOSTname?

Arguments

None

Default value

Not applicable

Example

SYST:COMM:LAN:HOST?

Returns

<SRD>

SYSTem:COMMunicate:LAN:DESCription?

This command queries the host name description in the LAN communication.

Syntax

SYSTem:COMMunicate:LAN:DESCription?

Arguments

None

Default value

Not applicable

Example

SYST:COMM:LAN:DESC?

Returns

<SRD>

SYSTem:COMMunicate:LAN:DOMain?

This command queries the domain in the LAN communication.

Syntax

SYSTem:COMMunicate:LAN:DOMain?

Arguments

None

Default value

Not applicable

Example

SYST:COMM:LAN:DOM?

Returns

<SRD>

SYSTem:POSetup <CPD>

This command is used to set some parameter settings or working status when the instrument is powered on.

Syntax

SYSTem:POSetup <CPD>

Arguments

RST|Last|Last+Off

Default value

RST

Example

SYST:POS Last

Query command

SYSTem:POSetup?

Returns

RST|Last|Last+Off

SYSTem:READY?

This command indicates whether the instrument is ready or not.

Syntax

SYSTem:READY?

Arguments

None

Default value

Not applicable

Example

SYST:READ?

Returns

0|1

Chapter8 List Commands

LIST:STEP:COUNT <NR1>

This command sets the total steps of the list program.

Syntax

LIST:STEP:COUNT <NR1>

Arguments

<1-100>

Default value

Not applicable

Example

LIST:STEP:COUNT 1

Query command

LIST:STEP:COUNT?

Returns

NR1

LIST:STEP:VOLTage <NR1>,<NRf+>

This command sets the voltage value of the nth step in the list program.

Syntax

LIST:STEP:VOLTage <NR1>,<NRf+>

Arguments

<1-100>,<MINimum-MAXimum|MINimum|MAXimum>

Default value

Not applicable

Example

LIST:STEP:VOLT 1,100.00

Query command

LIST:STEP:VOLTage? <NR1>

Returns

NR2

LIST:STEP:CURRent <NR1>,<NRf+>

This command sets the current value of the nth step in the list program.

Syntax

LIST:STEP:CURRent <NR1>,<NRf+>

Arguments

<1-100>,<MINimum-MAXimum|MINimum|MAXimum>

Default value

Not applicable

Example

LIST:STEP:CURR 1,3.500

Query command

LIST:STEP:CURRent? <NR1>

Returns

NR2

LIST:STEP:SLEW <NR1>,<NRf+>

This command sets the slew rate value of the nth step in the list program.

Syntax

LIST:STEP:SLEW <NR1>,<NRf+>

Arguments

<1-100>,<MINimum-MAXimum|MINimum|MAXimum>

Default value

Not applicable

Example

LIST:STEP:SLEW 1,1.000

Query command

LIST:STEP:SLEW? <NR1>

Returns

NR2

LIST:STEP:WIDTH <NR1>,<NRf+>

This command sets the width value of the nth step in the list program.

Syntax

LIST:STEP:WIDTH <NR1>,<NRf+>

Arguments

<1-100>,<MINimum-MAXimum|MINimum|MAXimum>

Default value

Not applicable

Example

LIST:STEP:WIDT 1,1.000

Query command

LIST:STEP:WIDTH? <NR1>

Returns

NR2

LIST:REPeat <NR1>

This command sets the number of list repetitions.

Syntax

LIST:REPeat <NR1>

Arguments

<MINimum-MAXimum|MINimum|MAXimum>

Default value

Not applicable

Example

LIST:REP 3

Query command

LIST:REPeat?

Returns

NR1

LIST:FUNCTION <CPD>

This command sets the working mode of list program.

Syntax

LIST:FUNCTION <CPD>

Arguments

<CPD>
VOLTage|CURRent

Default value

Not applicable

Example

LIST:FUNC VOLT

Query command

LIST:FUNCTION?

Returns

VOLTage|CURRent

LIST:SAVE <NR1>

This command saves the present list program into the specified memory.

Syntax

LIST:SAVE <NR1>

Arguments

<1-10>

Default value

Not applicable

Example

LIST:SAVE 1

Query command

None

Returns

None

LIST:RECall <NR1>

This command recalls the list program you saved in the specified memory location.

Syntax

LIST:RECall <NR1>

Arguments

<1-10>

Default value

Not applicable

Example

LIST:REC 1

Query command

None

Returns

None

LIST[:STATe] <bool>

This command enables or disables the list function.

Syntax

LIST[:STATe] <bool>

Arguments

<0|OFF|1|ON >

Default value

Not applicable

Example

LIST ON

Query command

LIST[:STATe]?

Returns

0|1

LIST:TERMinate <CPD>

This command sets the end state of the list program.

Syntax

LIST:TERMinate <CPD>

Arguments

<CPD>
NORMal|LAST

Default value

Not applicable

Example

LIST:TERM NORM

Query command

LIST:TERMinate?

Returns

NORMal|LAST

LIST:PAUSe[:STATe] <bool>

This command sets the pause state of the list program.

Syntax

LIST:PAUSe[:STATe] <bool>

Arguments

<0|OFF|1|ON>

Default value

Not applicable

Example

LIST:PAUS 1

Query command

LIST:PAUSe[:STATe]?

Returns

0|1

LIST:RUN:STEP?

This command queries the present step number of the running list program.

Syntax

LIST:RUN:STEP?

Arguments

None

Default value

Not applicable

Example

LIST:RUN:STEP?

Returns

NR1

LIST:RUN:REPeat?

This command queries the present repetitions of the running list program.

Syntax

LIST:RUN:REPeat?

Arguments

None

Default value

Not applicable

Example

LIST:RUN:REP?

Returns

NR1

Chapter9 Trace Commands

TRACe:CLEAr

This command is used to clear reading cache. If cache is not cleared, subsequent saving will overwrite the previous data.

Syntax

TRACe:CLEAr

Arguments

None

Default value

Not applicable

Example

TRAC:CLE

Query command

None

Returns

None

TRACe:POINts <NR1>

This command is used to specify cache size.

Syntax

TRACe:POINts <NR1>

Arguments

<2-2000>|MINimum|MAXimum

Default value

2000

Example

TRAC:POIN MAX

Query command

TRACe:POINts?

Returns

NR1

TRACe:FEED:CONTRol <CPD>

This command is used to select cache control. Select NEVer, Save to Cache is disabled; select NEXT, save process starts and will stop when the cache is filled in. Select ALWays. After cache is filled in, circulate the cache.

Syntax

TRACe:FEED:CONTRol <CPD>

Arguments

<CPD>
NEVer|NEXT|ALWays

Default value

NEVer

Example

TRAC:FEED:CONT NEXT

Query command

TRACe:FEED:CONTRol?

Returns

NEVer|NEXT|ALWays

TRACe:FEED[:SELeCted] <CPD>

This command selects the reading source saved in the cache. If VOLTage is selected, the voltage reading is saved in cache; if CURRent is selected, the current reading is saved in cache. If VOLTage and CURRent are simultaneously selected, both voltage and current are saved in cache when saving is executed.

Syntax

TRACe:FEED[:SELeCted] <CPD>

Arguments

<CPD>

VOLTage|CURRent|BOTH

Default value

BOTH

Example

TRAC:FEED BOTH

Query command

TRACe:FEED?

Returns

VOLTage|CURRent|BOTH

TRACe:DELay <NRf+>

This command selects cache delay time.

Syntax

TRACe:DELay <NRf+>

Arguments

0 to 3600s|MINimum|MAXimum

Default value

0.001s

Example

TRAC:DEL MINimum

Query command

TRACe:DELay?

Returns

NR2

TRACe:TIMer <NRf+>

This command selects cache time interval.

Syntax

TRACe:TIMer <NRf+>

Arguments

<0.001-3600>
MINimum-MAXimum|MINimum|MAXimum

Default value

0.001S

Example

TRAC:TIM 230

Query command

TRACe:TIMer?

Returns

NR2

TRACe:POINts:ACTual?

This command selects number of actual readings in the cache.

Syntax

TRACe:POINts:ACTual?

Arguments

None

Default value

0

Example

TRAC:POIN:ACT?

Returns

NR1

TRACe:DATA?

This command reads all values saved in the cache.

 **Note**

Before sending the query command TRACe:DATA?, the command TRIGger[:IMMediate] must be sent to the instrument to trigger the instrument into data storage status. And the argument of the command TRACe:FEED:CONTRol <NEXT|ALWays|NEVer> must be set to NEXT or ALWays, otherwise the system will prompt an error.

Syntax

TRACe:DATA?

Arguments

None

Default value

Not applicable

Example

TRACe:DATA?

Returns

{<NRf>,<NRf>,<NRf>,<NRf>...,<NRf>}

TRACe:FILTer[:STATe] <bool>

This command enables or disables the filter.

Syntax

TRACe:FILTer[:STATe] <bool>

Arguments

<0|OFF|1|ON>

Default value

1

Example

TRAC:FILT 1

Query command

TRACe:FILTer[:STATe]?

Returns

0|1

Chapter10 DISPlay Commands

DISPlay[:WINDow][:STATe] <bool>

This command is used to open or close full panel display.

Syntax

DISPlay[:WINDow][:STATe] <bool>

Arguments

<0|OFF|1|ON>

Example

DISP 1

Query command

DISPlay[:WINDow][:STATe]?

Return

0|1

DISPlay[:WINDow]:TEXT <SPD>

This command is used to display a message on the front panel display.

Syntax

DISPlay[:WINDow]:TEXT <SPD>

Arguments

Not applicable

Example

DISP:TEXT "hello"

Query command

DISPlay[:WINDow]:TEXT?

Return

<SRD>

DISPlay[:WINDow]:TEXT:CLEAr

This command is used to clear the message displayed on the front panel display.

Syntax

T DISPlay[:WINDow]:TEXT:CLEAr

Arguments

None

Example

DISP:TEXT:CLE

Return

None

DISPlay[:WINDow]:MODE <CPD>

This command is used to control the display mode of the display.

Syntax

DISPlay[:WINDow]:MODE <CPD>

Arguments

NORMAl|TEXT

Example

DISP:MODE NORM

Query command

DISPlay[:WINDow]:MODE?

Return

NORMAl|TEXT

Chapter11 Status Commands

STATus:OPERation[:EVENT]?

This command reads the Operation Event Register of the status model.

Syntax

STATus:OPERation[:EVENT]?

Arguments

None

Default value

Not applicable

Example

STAT:OPER?

Returns

NR1

STATus:OPERation:CONDition?

This command reads the Operation Condition Register of the status model.

Syntax

STATus:OPERation:CONDition?

Arguments

None

Default value

Not applicable

Example

STAT:OPER:COND?

Returns

NR1

STATus:OPERation:ENABLE <NR1>

This command sets the Operation Event Enable Register of the status model.

Syntax

STATus:OPERation:ENABLE <NR1>

Arguments

<0 to 65535>

Default value

Not applicable

Example

STAT:OPER:ENAB 16

Query command

STATus:OPERation:ENABLE?

Returns

NR1

STATus:OPERation:NTRansition <NR1>

This command sets the negative value of the Operation Event Register.

Syntax

STATus:OPERation:NTRansition <NR1>

Arguments

<0 to 65535>

Default value

Not applicable

Example

STAT:OPER:NTR 16

Query command

STATus:OPERation:NTRansition?

Returns

NR1

STATus:OPERation:PTRansition <NR1>

This command sets the positive value of the Operation Event Register.

Syntax

STATus:OPERation:PTRansition <NR1>

Arguments

<0-65535>

Default value

Not applicable

Example

STAT:OPER:PTR 32

Query command

STATus:OPERation:PTRansition?

Returns

NR1

STATus:QUEStionable[:EVENT]?

This command queries the Questionable Event Register of the status model.

Syntax

STATus:QUEStionable[:EVENT]?

Arguments

None

Default value

Not applicable

Example

STAT:QUES?

Returns

NR1

STATus:QUEStionable:CONDition?

This command queries the Questionable Condition Register of the status model

Syntax

STATus:QUEStionable:CONDition?

Arguments

None

Default value

Not applicable

Example

STAT:QUES:COND?

Returns

NR1

STATus:QUEStionable:ENABLE <NR1>

This command sets the Questionable Event Enable Register (QENR) of the status model

Syntax

STATus:QUEStionable:ENABLE <NR1>

Arguments

<0 to 65535>

Default value

Not applicable

Example

STAT:QUES:ENAB 24

Query command

STATus:QUEStionable:ENABLE?

Returns

NR1

STATus:QUEStionable:NTRansition <NR1>

This command sets the negative value of the Questionable Event Register.

Syntax

STATus:QUEStionable:NTRansition <NR1>

Arguments

<0 to 65535>

Default value

Not applicable

Example

STAT:QUES:NTR 64

Query command

STATus:QUEStionable:NTRansition?

Returns

NR1

STATus:QUEStionable:PTRansition <NR1>

This command sets the positive value of the Questionable Event Register.

Syntax

STATus:QUEStionable:PTRansition <NR1>

Arguments

<0 to 65535>

Default value

Not applicable

Example

STAT:QUES:PTR 32

Query command

STATus:QUEStionable:PTRansition?

Returns

NR1

STATus:PRESet

This command resets all bits in the status model.

Syntax

STATus:PRESet

Arguments

None

Default value

Not applicable

Example

STAT:PRES

Query command

None

Returns

None

Chapter12 Trigger Commands

TRIGger[:IMMediate]

This command generates a trigger signal when the trigger source is BUS.

Syntax

TRIGger[:IMMediate]

Arguments

None

Default value

Not applicable

Example

TRIG

Query command

None

Returns

None

TRIGger:SOURce <CPD>

This command sets the trigger source.

Syntax

TRIGger:SOURce <CPD>

Arguments

KEYPad|BUS|EXT

Default value

KEYPad

Example

TRIG:SOUR KEYP

Query command

TRIGger:SOURce?

Returns

KEYPad|BUS|EXT

TRIGger:EXTernal:DIRection <CPD>

Set the rear panel interface TRIG± receiving and transmitting status, and control the trigger input/output signal of the instrument.

Syntax

TRIGger:EXTernal:DIRection <CPD>

Arguments

IN|OUT

Default value

OUT

Example

TRIG:EXT:DIR IN

Query command

TRIGger:EXTernal:DIRection?

Returns

IN|OUT

Chapter13 Common Commands

***CLS**

This command clears the error queue and the bits of the following registers:

- Standard Event Register
- Questionable Event Register
- Status byte register

Syntax

*CLS

Arguments

None

Default value

Not applicable

Example

*CLS

Query command

None

Returns

Not applicable

***ESE**

This command sets or queries the bits in the Event Status Enable Register (ESER). The ESER is an eight-bit register that determines which bits in the Standard Event Status Register (SESR) will set the Event Summary Bit (ESB) in the Status Byte Register (SBR).

Syntax

*ESE <NRf>

Arguments

0 to 255

Default value

0

Example

*ESE 16

Query command

*ESE?

Returns

NR1

***ESR?**

This command reads the value of Standard Event Status Register (SESR). Once this command executes, the SESR is reset. The bit definition for the SESR is the same as the Standard Event Status Enable Register.

Syntax

*ESR?

Arguments

None

Default value

Not applicable

Example

*ESR?

Returns

NR1

See also

*CLS
*ESE
*ESE?
*OPC

***IDN?**

This command reads information that identifies the power supply. It returns a parameter that contains four segments divided by a comma. Example: ITECH Ltd., IT-M3140, 60234567890123456, 1.01-1.02-1.03.

Syntax

*IDN?

Arguments

None

Default value

Not applicable

Example

```
- > *IDN?  
< - ITECH Ltd.,IT-M3140,60234567890123456,1.01-1.02-1.03
```



Note

- “- >” indicates the commands that you send to the IT-M3140 power supply.
- “< -” indicates the response from the IT-M3140 power supply.

Returns

AARD

*OPC

This command sets the Operation Complete (OPC) bit in the Standard Event Status Register to 1 when all other commands are complete.

Syntax

*OPC

Arguments

None

Default value

Not applicable

Example

```
*OPC
```

Query command

```
*OPC?
```

Returns

NR1

*PSC <Boolean>

This command specifies whether the Service Request Enable Register (SRER) and the Event State Enable Register (ESER) are cleared when the instrument is powered on. The query form of this command gets the state of the power-on status

clear function.

Syntax

*PSC <Boolean>

Arguments

0|OFF|1|ON

Default value

0

Example

*PSC 0

Query command

*PSC?

Returns

0|1

*RCL <NRf>

This command recalls the setups you saved in the specified memory location.

Syntax

*RCL <NRf>

Arguments

<1-10>

Default value

Not applicable

Example

*RCL 1

Query command

None

Returns

Not applicable

*RST

This command resets the power supply to default settings.

Syntax

*RST

Arguments

None

Default value

Not applicable

Example

*RST

Query command

None

Returns

Not applicable

***SAV**

This command saves the present setting values of the power supply into specified memory

Syntax

*SAV <NRf>

Arguments

<1-10>

Default value

Not applicable

Example

*SAV 1

Query command

None

Returns

Not applicable

***SRE**

This command sets or queries the bits in the Status Byte Enable Register. Setting this parameter can determine which byte of the Status Byte Register

has a value of 1. The byte sets the RQS bit of the Status Byte Register to 1. The bit definition of the Status Byte Enable Register is as the same as the Status Byte Register.

Syntax

*SRE <NRf>

Arguments

0 to 255

Default value

Not applicable

Example

*SRE 255

Query command

*SRE?

Returns

NR1

***STB?**

This command reads the data in the Status Byte Register (SBR).

Syntax

*STB?

Arguments

None

Default value

Not applicable

Example

*STB?

Returns

NR1

***TRG**

This command generates a trigger signal when the trigger source is BUS.

Syntax

*TRG

Arguments

None

Default value

Not applicable

Example

*TRG

Query command

None

Returns

None

***TST?**

This command initiates a self-test and reports any errors.

Query command

*TST?

Arguments

None

Default value

Not applicable

Example

*TST?

Returns

NR1,<str>

***WAI**

Pauses additional command processing until all pending operations are complete.

Query command

*WAI

Arguments

None

Default value

Not applicable

Example

*WAI

Returns

None

Chapter14 Programming Examples

This chapter displays the programming examples to remotely control IT-M3140 power supply using SCPI commands.



Note

- If the user want to change the settings of the instrument, for instance, the output setting value, the command SYST:REM must be sent to the instrument after finishing the connection between the instrument and PC.
- “ - >” indicates the commands that you send to the IT-M3140 power supply.

Example1: Identifying the Power Supply in Use

You can verify whether you are communicating with the right IT-M3140 power supply.

To query the identification of the power supply, send the command:

```
-> *IDN?
```

To check the power supply error queue, send the command:

```
-> SYST:ERR?
```

Example2: Setting the Common Output Arguments

To set the output voltage to 10 V, send the command:

```
-> VOLT 10.00
```

To set the output current to 3.5 A, send the command:

```
-> CURR 3.500
```

You can also the following command to set the output voltage to 10 V and set the output current to 3.5 A simultaneously:

```
-> APPL 10.00,3.500
```

To select the voltage priority mode or current priority mode, send the command:

```
-> FUNC:PRI VOLT|CURR
```

To set the delay time to 1 second before turning the output on, send the command:

```
-> OUTP:DEL 1.0
```

To set the delay time to 1 second after turning the output off, send the command:

```
-> OUTP:DEL:OFF 1.0
```

To set the timer to 100 seconds for the output, send the commands:

```
-> OUTP:TIM ON
```

```
-> OUTP:TIM:DEL 100
```

Example3: List Function

To specify manual trigger, BUS trigger or external trigger for the trigger source, send the command:

```
-> TRIGger:SOURce KEYPad|BUS|EXT
```

To specify V mode or I mode for list operation mode, send the command:

```
-> LIST:FUNC VOLT|CURR
```

To set the end state of list program to stop normally or keep the last output, send the command:

```
-> LIST:TERM NORM|LAST
```

To set the number of list repetitions to 3, send the command:

```
-> LIST:REP 3
```

To set the total steps of list program to 10, send the command:

```
-> LIST:STEP:COUN 10
```

To set the voltage to 10 V for the first step in the list program, send the command:

```
-> LIST:STEP:VOLT 1,10.00
```

To set the current to 3.5 A for the first step in the list program, send the command:

```
-> LIST:STEP:CURR 1,3.500
```



Note

When you specify V mode for list operation mode, you only need to set the voltage value for each step. When you specify I mode for list operation mode, you only need to set the current value for each step.

To set the slew rate to 1 second for the first step in the list program, send the command:

```
-> LIST:STEP:SLEW 1,1.000
```

To set the width value to 1 second for the first step in the list program, send the command:

```
-> LIST:STEP:WIDT 1,1.000
```

To save the present list program into the List File 1, send the command:

```
-> LIST:SAVE 1
```

To enable the list function, send the command:

-> LIST ON or FUNC:MODE LIST

To turn the output on, send the command:

-> OUTP ON

When the trigger source is set to BUS, send the following command to generate a trigger:

-> TRIG

Chapter15 Error Messages

Error List

Sending the command `SYST:ERR?` can read one error code and error message from the error queue.

Error code	Error message
101	"Too many numeric suffices"
110	"No input command"
114	"Invalid Numeric suffix"
116	"Invalid value"
117	"Invalid dimensions"
120	"Parameter overflowed"
130	"Wrong units for parameter"
140	"Wrong type of parameter"
150	"Wrong number of parameter"
160	"Unmatched quotation mark"
165	"Unmatched bracket"
170	"Invalid command"
180	"No entry in list"
190	"Too many dimensions"
191	"Too many char"
-200	"Execution error"
-221	"Settings conflict"
-222	"Data out of range"
-223	"Too much data"
-224	"Illegal parameter value"
-225	"Out of memory"
-230	"Data Corrupt or Stale"
-270	"Macro error"
0	"No error"
1	"Module Initialization Lost"
2	"Mainframe Initialization Lost"
3	"Module Calibration Lost"
4	"Eeprom failure"
5	"RST checksum failed"
6	"BACKUP RAM failed"
7	"TRIG_SOURCE_ERR"
10	"RAM selftest failed"
222	"Front panel uart parity"
223	"Front panel buffer overrun"

224	"Front panel timeout"
225	"Front Crc Check error"
226	"Front Cmd Error"
401	"CAL switch prevents"
402	"CAL password is incorrect"
403	"CAL not enabled"
404	"readback cal are incorrect"
405	"programming cal are incorrect"
406	"Incorrect sequence of cal"
602	"Commond only for rs232"
603	"FETCH of data was not acquired"
604	"Measurement overrange"
701	"LIST_SIZE_OVER"
702	"DATA_OVERFLOW"
800	"Sn Same Conflict"

Contact US

Thank you for purchasing ITECH products. If you have any doubt about this product, please contact us as follow.

1. Visit ITECH website www.itechate.com .
2. Select the most convenient contact for further consultation.