

Programmable Power Supply

IT-N6900 Series Programming Guide



Model: IT-N6900
Version: V2.0

Notices

© Itech Electronic, Co., Ltd. 2025

No part of this manual may be reproduced in any form or by any means (including electronic storage and retrieval or translation into a foreign language) without prior permission and written consent from Itech Electronic, Co., Ltd. as governed by international copyright laws.

Manual Part Number

IT-N6900

Revision

Second Edition: Feb. 21,
2025

Itech Electronic, Co., Ltd.

Trademarks

Pentium is U.S. registered trademarks of Intel Corporation.

Microsoft, Visual Studio, Windows and MS Windows are registered trademarks of Microsoft Corporation in the United States and/or other countries and regions.

Warranty

The materials contained in this document are provided “as is”, and is subject to change, without prior notice, in future editions. Further, to the maximum extent permitted by applicable laws, ITECH disclaims all warranties, either express or implied, with regard to this manual and any information contained herein, including but not limited to the implied warranties of merchantability and fitness for a particular purpose. ITECH shall not be held liable for errors or for incidental or indirect damages in connection with the furnishing, use or application of this document or of any information contained herein. Should ITECH and the user enter into a separate written agreement with warranty terms covering the materials in this document that conflict with these terms, the warranty terms in the separate agreement shall prevail.

Technology Licenses

The hardware and/or software described herein are furnished under a license and may be used or copied only in accordance with the terms of such license.

Restricted Rights Legend

Restricted permissions of the U.S. government. Permissions for software and technical data which are authorized to the U.S. Government only include those for custom provision to end users. ITECH follows FAR 12.211 (technical data), 12.212 (computer software), DFARS 252.227-7015 (technical data--commercial products) for national defense and DFARS 227.7202-3 (permissions for commercial computer software or computer software documents) while providing the customized business licenses of software and technical data.

Safety Notices

CAUTION

A CAUTION sign denotes a hazard. It calls attention to an operating procedure or practice that, if not correctly performed or adhered to, could result in damage to the product or loss of important data. Do not proceed beyond a CAUTION sign until the indicated conditions are fully understood and met.

WARNING

A WARNING sign denotes a hazard. It calls attention to an operating procedure or practice that, if not correctly performed or adhered to, could result in personal injury or death. Do not proceed beyond a WARNING sign until the indicated conditions are fully understood and met.



NOTE

A NOTE sign denotes important hint. It calls attention to tips or supplementary information that is essential for users to refer to.

Quality Certification and Assurance

We certify that IT-N6900 series instruments meet all the published specifications at time of shipment from the factory.

Warranty

ITECH warrants that the product will be free from defects in material and workmanship under normal use for a period of one (1) year from the date of delivery (except those described in the Limitation of Warranty below).

For warranty service or repair, the product must be returned to a service center designated by ITECH.













- The product returned to ITECH for warranty service must be shipped PREPAID. And ITECH will pay for return of the product to customer.
- If the product is returned to ITECH for warranty service from overseas, all the freights, duties and other taxes shall be on the account of customer.



Limitation of Warranty

This Warranty will be rendered invalid in case of the following:

- Damage caused by circuit installed by customer or using customer own products or accessories;
- Modified or repaired by customer without authorization;
- Damage caused by circuit installed by customer or not operating our products under designated environment;
- The product model or serial number is altered, deleted, removed or made illegible by customer;
- Damaged as a result of accidents, including but not limited to lightning, moisture, fire, improper use or negligence.

Safety Symbols

	Direct current		ON (power on)
	Alternating current		OFF (power off)
	Both direct and alternating current		Power-on state
	Protective conductor terminal		Power-off state
	Earth (ground) terminal		Reference terminal
	Caution, risk of electric shock		Positive terminal

	Warning, risk of danger (refer to this manual for specific Warning or Caution information)	—	Negative terminal
	Frame or chassis terminal	-	-

Safety Precautions

The following safety precautions must be observed during all phases of operation of this instrument. Failure to comply with these precautions or specific warnings elsewhere in this manual will constitute a default under safety standards of design, manufacture and intended use of the instrument. ITECH assumes no liability for the customer's failure to comply with these precautions.

WARNING

- Do not use the instrument if it is damaged. Before operation, check the casing to see whether it cracks. Do not operate the instrument in the presence of inflammable gasses, vapors or dusts.
- The electronic load is provided with a power line during delivery and should be connected to a socket with a protective earth terminal. Before operation, be sure that the instrument is well grounded.
- Make sure to use the power cord supplied by ITECH.
- Check all marks on the instrument before connecting the instrument to power supply.
- Use electric wires of appropriate load. All loading wires should be capable of bearing maximum short-circuit current of electronic load without overheating. If there are multiple electronic loads, each pair of the power cord must be capable of bearing the full-loaded rated short-circuit output current
- Ensure the voltage fluctuation of mains supply is less than 10% of the working voltage range in order to reduce risks of fire and electric shock.
- If you use the power supply to charge the battery, pay attention to the positive and negative polarity of the battery when wiring, otherwise the power supply will be damaged!
- Do not install alternative parts on the instrument or perform any unauthorized modification.
- Do not use the instrument if the detachable cover is removed or loosen.
- To prevent the possibility of accidental injuries, be sure to use the power adapter supplied by the manufacturer only.
- We do not accept responsibility for any direct or indirect financial damage or loss of profit that might occur when using the instrument.
- This instrument is used for industrial purposes, do not apply this product to IT power supply system.
- Never use the instrument with a life-support system or any other equipment subject to safety requirements.

CAUTION

- Failure to use the instrument as directed by the manufacturer may render its protective features void.
- Always clean the casing with a dry cloth. Do not clean the internals.
- Make sure the vent hole is always unblocked.

Environmental Conditions





The instrument is designed for indoor use and an area with low condensation. The table below shows the general environmental requirements for the instrument.

Environmental Conditions	Requirements
Operating temperature	0°C to 40°C
Operating humidity	20%-80% (non-condensation)
Storage temperature	-10°C to 70 °C
Altitude	Operating up to 2,000 meters
Pollution degree	Pollution degree 2
Installation category	II

Note

To make accurate measurements, allow the instrument to warm up for 30 min before operation.

Regulatory Markings

	The CE mark indicates that the product complies with all the relevant European legal directives. The specific year (if any) affixed refers to the year when the design was approved.
	The UKCA mark indicates that the product complies with all relevant UK legal regulations (if accompanied by a year, it indicates the year the design was approved).
	The instrument complies with the WEEE Directive (2002/96/EC) marking requirement. This affixed product label indicates that you must not discard the electrical/electronic product in domestic household waste.
	This symbol indicates the time period during which no hazardous or toxic substances are expected to leak or deteriorate during normal use. The expected service life of the product is 10 years. The product can be used safely during the 10-year Environment Friendly Use Period (EFUP). Upon expiration of the EFUP, the product must be immediately recycled.

Waste Electrical and Electronic Equipment (WEEE) Directive



This product complies with the WEEE Directive (2002/96/EC) marking requirement. This affix product label indicates that you must not discard the electrical/electronic product in domestic household waste.

Product Category

With reference to the equipment classifications described in the Annex I of the WEEE Directive, this instrument is classified as a "Monitoring and Control Instrument".

To return this unwanted instrument, contact your nearest ITECH office.

Compliance Information

Complies with the essential requirements of the following applicable European Directives, and carries the CE marking accordingly:

- Electromagnetic Compatibility (EMC) Directive 2014/30/EU
- Low-Voltage Directive (Safety) 2014/35/EU

Conforms with the following product standards:

EMC Standard

IEC 61326-1:2012/ EN 61326-1:2013 ¹²³

Reference Standards

CISPR 11:2015+A1:2016 Ed 6.1

IEC 61000-3-2: 2018 RLV

IEC 61000-3-3: 2013+A1:2017

IEC 61000-4-2:2008

IEC 61000-4-3 2006+A1:2007+A2:2010/ EN 61000-4-3 A1:2008+A2:2010

IEC 61000-4-4:2012

IEC 61000-4-5:2014+A1:2017

IEC 61000-4-6:2013+cor1:2015

IEC 61000-4-11:2004+A1:2017

1. The product is intended for use in non-residential/non-domestic environments. Use of the product in residential/domestic environments may cause electromagnetic interference.
2. Connection of the instrument to a test object may produce radiations beyond the specified limit.
3. Use high-performance shielded interface cable to ensure conformity with the EMC standards listed above.

Safety Standard

IEC 61010-1:2010+A1:2016

Contents

Quality Certification and Assurance	i
Warranty	i
Limitation of Warranty	i
Safety Symbols	i
Safety Precautions	ii
Environmental Conditions	iii
Regulatory Markings	iii
Waste Electrical and Electronic Equipment (WEEE) Directive	iv
Compliance Information	v
Chapter1 Remote Control	1
1.1 Overview	1
1.2 SCPI Command Introduction	1
1.3 Command Type of SCPI	1
1.4 Command Format	3
1.5 Data Type	6
1.6 Remote Operation	7
Chapter2 Example	8
Chapter3 SCPI Status Register	10
Chapter4 STATus Subsystem	13
STATus:QUEStionable[:EVENT]?	13
STATus:QUEStionable:ENABle <state>	13
STATus:QUEStionable:PTRansition <NR1>	14
STATus:QUEStionable:NTRansition <NR1>	14
STATus:QUEStionable:CONDition?	15
STATus:OPERation[:EVENT]?	15
STATus:OPERation:CONDition?	16
STATus:OPERation:ENABle	16
STATus:OPERation:PTRansition <NR1>	17
STATus:OPERation:NTRansition <NR1>	17
STATus:PRESet	18
Chapter5 System Subsystem	20
SYSTem:BEEPer[:IMMEDIATE]	20
SYSTem:BEEPer:STATe <BOOL>	20
SYSTem:VERSion?	21
SYSTem:ERRor[:NEXT]?	21
SYSTem:REMote	22
SYSTem:LOCal	22
SYSTem:RWLock	22
SYSTem:KEY <NR1>	23
SYSTem:REBoot	23
SYSTem:COMMunicate:LAN:CURRent:ADDReSS <SPD>	24
SYSTem:COMMunicate:LAN:CURRent:DGATeway <SPD>	24
SYSTem:COMMunicate:LAN:CURRent:SMASK <SPD>	25
SYSTem:COMMunicate:LAN:DHCP <BOOL>	25
SYSTem:COMMunicate:LAN:SOCKetport <NR1>	26
SYSTem:COMMunicate:LAN:MACAdDress?	26
SYSTem:COMMunicate:SERial:BAUDrate	27
SYSTem:COMMunicate:LAN:DNS1 <SPD>	27
SYSTem:COMMunicate:LAN:DNS2 <SPD>	28
SYSTem:COMMunicate:LAN:REStore	28
SYSTem:COMMunicate:LAN:SAVe	29
SYSTem:COMMunicate:LAN:STATe?	29

SYSTem:COMMunicate:LAN:HOSTname?	29
SYSTem:COMMunicate:LAN:DESCription?	30
SYSTem:COMMunicate:GPIB:RDEVice:ADDRess <addr>	30
SYSTem:BRIGhtness <NR1>	31
Chapter6 SENSE Subsystem	32
SENSe[:REMote][:STATe] <BOOL>	32
SENSe:FILTer:LEVel <SLOW MEDIum FAST>	32
Chapter7 TRIGger Subsystem	33
TRIGger[:IMMediate]	33
TRIGger:SOURce <MANUal BUS EXTernal>	33
TRIGger:EXTernal:DIRection <IN OUT>	33
Chapter8 OUTPut Subsystem	35
OUTPut[:STATe][:ALL] <BOOL>	35
OUTPut:PROTection:CLEar	35
OUTPut:DELay[:ON] <NRf+>	35
OUTPut:DELay:OFF <NRf+>	36
OUTPut:TIMer[:STATe] <BOOL>	36
OUTPut:TIMer:DELay <NRf+>	37
OUTPut:PROTection:FOLDback[:MODE] <OFF CC CV>	37
OUTPut:PROTection:FOLDback:DELay <NRf+>	38
OUTPut:PONSetup[:STATe] <RST LAST LOFF>	38
OUTPut:INHibit:MODE <OFF LIVing LATCh>	39
Chapter9 SOURce Subsystem	40
[SOURce:]CURRent[:LEVel][:IMMediate][:AMPLitude] <NRf+>	40
[SOURce:]CURRent[:LEVel]:TRIGgered[:AMPLitude] <NRf+>	40
[SOURce:]CURRent:OVER:PROTection[:LEVel] <NRf+>	41
[SOURce:]CURRent:OVER:PROTection:DELay <NRf+>	41
[SOURce:]CURRent:OVER:PROTection:STATe <BOOL>	42
[SOURce:]CURRent:UNDer:PROTection[:LEVel] <NRf+>	42
[SOURce:]CURRent:UNDer:PROTection:DELay <NRf+>	43
[SOURce:]CURRent:UNDer:PROTection:STATe <BOOL>	43
[SOURce:]CURRent:UNDer:PROTection:WARM <NRf+>	44
[SOURce:]CURRent:SLEW[:BOTH] <NRf+>	44
[SOURce:]CURRent:SLEW:NEGative <NRf+>	44
[SOURce:]CURRent:SLEW:POSitive <NRf+>	45
[SOURce:]CURRent:DECimal?	45
[SOURce:]CURRent:RANGe <AUTO HIGH LOW>	46
[SOURce:]CURRent[:LEVel]:LIMit[:HIGH] <NRf+>	46
[SOURce:]VOLTage[:LEVel][:IMMediate][:AMPLitude] <NRf+>	47
[SOURce:]VOLTage[:LEVel]:TRIGgered[:AMPLitude] <NRf+>	47
[SOURce:]VOLTage:SLEW[:BOTH] <NRf+>	48
[SOURce:]VOLTage:SLEW:NEGative <NRf+>	48
[SOURce:]VOLTage:SLEW:POSitive <NRf+>	49
[SOURce:]VOLTage:OVER:PROTection[:LEVel] <NRf+>	49
[SOURce:]VOLTage:OVER:PROTection:DELay <NRf+>	49
[SOURce:]VOLTage:OVER:PROTection:STATe <BOOL>	50
[SOURce:]VOLTage:UNDer:PROTection[:LEVel] <NRf+>	50
[SOURce:]VOLTage:UNDer:PROTection:DELay <NRf+>	51
[SOURce:]VOLTage:UNDer:PROTection:STATe <BOOL>	52
[SOURce:]VOLTage:UNDer:PROTection:WARM <NRf+>	52
[SOURce:]VOLTage[:LEVel]:LIMit[:HIGH] <NRf+>	53
[SOURce:]VOLTage:DECimal?	53
[SOURce:]POWER[:LEVel]:LIMit[:HIGH] <NRf+>	53

[SOURce:]POWer:PROTection[:LEVel] <NRf+>	54
[SOURce:]POWer:PROTection:DELAy <NRf+>	54
[SOURce:]POWer:PROTection:STATe <BOOL>	55
[SOURce:]POWer:DECimal?	55
[SOURce:]FUNctIon:MODE <FIXed LIST>	56
[SOURce:]FUNctIon:PRiority <VOLTage CURRent>	56
[SOURce:]APPLy <NRf+>,<NRf+>	56
[SOURce:]EXTErn[:PROGrama][:STATe] <BOOL>	57
[SOURce:]EXTErn[:PROGrama]:CHANnel:MX <NR1>,<NRf+>	57
[SOURce:]EXTErn[:PROGrama]:CHANnel:MB <NR1>,<NRf+>	58
[SOURce:]LEAK[:STATe] <BOOL>	59
[SOURce:]FUNctIon:SLEW:MODE <TIME RATE>	59
Chapter10 FETCh & MEASure Subsystem	60
MEASure[:SCALar]:CURRent[:DC]?	60
FETCh[:SCALar]:CURRent[:DC]?	60
MEASure[:SCALar]:VOLTage[:DC]?	60
FETCh[:SCALar]:VOLTage[:DC]?	60
MEASure[:SCALar]:POWer[:DC]?	61
FETCh[:SCALar]:POWer[:DC]?	61
MEASure:ALL?	61
FETCh:ALL?	61
FETCh:TIME?	62
Chapter11 LIST Subsystem	63
LIST:STEP:COUNT <NR1>	63
LIST:STEP:VOLTage <NR1>,<NRf+>	63
LIST:STEP:CURRent <NR1>,<NRf+>	64
LIST:STEP:SLEW <NR1>,<NRf+>	64
LIST:STEP:WIDTh <NR1>,<NRf+>	65
LIST:REPeat <NR1>	65
LIST:FUNctIon <VOLTage CURRent>	66
LIST:SAVE <NR1>	66
LIST:RECall <NR1>	66
LIST[:STATe] <BOOL>	67
LIST:TERMinate <NORMal LAST OFF>	67
LIST:PAUSe[:STATe] <BOOLEAN>	68
LIST:RUN:STEP?	68
LIST:RUN:REPeat?	69
Chapter12 TRACe Subsystem	70
TRACe:CLEar	70
TRACe:POINts <NR1>	70
TRACe:FEED:CONTRol <NEVer NEXT ALWays>	71
TRACe:FEED[:SELeCted] <VOLTage CURRent BOTH>	71
TRACe:DELAy	72
TRACe:TIMer	72
TRACe:POINts:ACTual?	72
TRACe:DATA?	73
TRACe:FILTer <BOOL>	73
Chapter13 IEEE-488 Command	75
*CLS	75
*ESE <NR1>	75
*IDN?	75
*OPC	76
*PSC <BOOL>	76

*RST	77
*SRE <NR1>	77
*STB?	77
*TRG	78
*SAV <NR1>	78
*RCL <NR1>	78
*TST?	79

Chapter1 Remote Control

1.1 Overview

This chapter will provide following remote configuration introductions:

- SCPI Command Introduction
- Command type
- Command format
- Data format
- Remote Operation

1.2 SCPI Command Introduction

SCPI is short for Standard Commands for Programmable Instruments which defines a communication method of bus controller and instrument. It is based on ASCII and supply for testing and measuring instruments. SCPI command is based on hierarchical architecture which also known as tree system. In this system, Relevant Command is returned to a common node or root, so that a subsystem is formed.

1.3 Command Type of SCPI

SCPI has two types of commands, common and subsystem.

- Common commands generally are not related to specific operation but to controlling overallelectronic load functions, such as reset, status, and synchronization. All commoncommands consist of a three-letter mnemonic preceded by an asterisk: *RST *IDN? *SRE 8.
- Subsystem commands perform specific electronic load functions. They are organized into an inverted tree structure with the "root" at the top. The following figure shows a portion of a subsyste command tree, from which you access the commands located along the various paths.

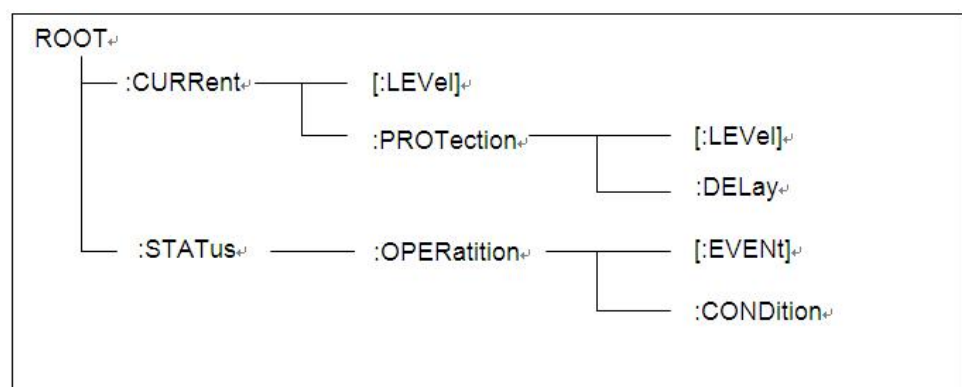

Multiple commands in a message

Multiple SCPI commands can be combined and sent as a single message with one message terminator. There are two important considerations when sending several commands within a single message:

- Use a semicolon to separate commands within a message.

- Head paths influence how the instrument interprets commands.

We consider the head path as a string which will be inserted in front of every command of a message. As for the first command of a message, the head path is a null string; for each subsequent command, the head path is a string which is defined to form the current command until and including the head of the last colon separator. A message with two combined commands: `CURR:LEV 3;PROT:STAT OFF`

The Example indicates the effect of semicolon and explains the concept of head path. Since the head path is defined to be "CURR" after "curr: lev 3", the head of the second command, "curr", is deleted and the instrument explains the second command as: `CURR:PROT:STAT OFF`

If "curr" is explicitly included in the second command, it is semantically wrong. Since combining it with the head path will become "CURR:CURR:PROT:STAT OFF", resulting in wrong command.

Movement in the subsystem

In order to combine commands from different subsystems, you need to be able to reset the header path to a null string within a message. You do this by beginning the command with a colon (:), which discards any previous header path. For Example, you could clear the output protection and check the status of the Operation Condition register in one message by using a root specifier as follows:

```
PROTection:CLEAr;:STATus:OPERation:CONDition?
```

The following message shows how to combine commands from different subsystems as well as within the same subsystem:

```
POWer:LEVel 200;PROTection 28; :CURRent:LEVel 3;PROTection:STATe ON
```

Note the use of the optional header `LEVel` to maintain the correct path within the voltage and current subsystems, and the use of the root specifier to move between subsystems.

Including Common Commands

You can combine common commands with subsystem commands in the same message. Treat the common command as a message unit by separating it with a semicolon (the message unit separator). Common commands do not affect the header path; you may insert them anywhere in the message.

```
VOLTage:TRIGgered 17.5;:INITialize;*TRG
```

```
OUTPut OFF;*RCL 2;OUTPut ONIT872X-3X SCPI Communication protocol 17
```

Case sensitivity

Common commands and SCPI commands are not case sensitive. You can use upper or lower for Example

```
*RST = *rst
:DATA? = :data?
:SYSTem:PRESet = :system:preset
```

Long-form and short-form versions

A SCPI command word can be sent in its long-form or short-form version. The command subsystem tables in Section 5 provide the in the long-form version. However, the short-form version is indicated by upper case characters. Example s:

:SYSTem:PRESet long-form

:SYST:PRES short form

:SYSTem:PRES long-form and short-form combination

Note that each command word must be in long-form or short-form, and not something in between.

For Example , :SYSTe:PRESe is illegal and will generate an error. The command will not be executed.

Query

Observe the following precautions with queries:

- Set up the proper number of variables for the returned data. For Example , if you are reading back a measurement array, you must dimension the array according to the number of measurements that you have placed in the measurement buffer.
- Read back all the results of a query before sending another command to the electronic load. Otherwise a Query Interrupted error will occur and the unreturned data will be lost.

1.4 Command Format

Formats for command display are as follows:

[SOURce[1|2]:]VOLTage:UNIT {VPP|VRMS|DBM}

[SOURce[1|2]:]FREQUency:CENTer
{<frequency>|MINimum|MAXimum|DEFault}

Based on the command syntax, most commands (and certain Parameter) are expressed in both upper and lower cases. Upper case refers to abbreviation of commands. Shorter program line may send commands in abbreviated format. Long-format commands may be sent to ensure better program readability.

For Example , both formats of VOLT and VOLTAGE are acceptable in the above syntax statements. Upper or lower case may be used. Therefore, formats of VOLTAGE, volt and Volt are all acceptable. Other formats (such as VOL and VOLTAG) are invalid and will cause errors.

- Parameter options with given command strings are included in the brace ({}). The brace is not sent along with command strings.
- Vertical stripes (|) separate several parameter options with given command strings. For Example , {VPP|VRMS|DBM} indicates that you may assign "APP", "VRMS" or "DBM" in the above commands. Vertical stripes are not sent along with command strings.
- Angle brackets (< >) in the second Example indicates that a value must be assigned to the parameter in the brace. For Example , the parameter in the angle bracket is <frequency> in the above syntax statements. Angle brackets are not sent along with command strings. You must assign a value (such as "FREQ:CENT 1000") to the parameter, unless you select other

options displayed in the syntax (such as "FREQ:CENT MIN").

- Some syntax elements (such as nodes and Parameter) are included in square brackets ([]). It indicates that these elements can be selected and omitted. Angle brackets are not sent along with command strings. If no value is assigned to the optional Parameter, the instrument will select a default value. In the above Example s, "SOURce[1|2]" indicates that you may refer to source channel 1 by "SOURce" or "SOURce1" or "SOUR1" or "SOUR". In addition, since the whole SOURce node is optional (in the square bracket), you can refer to the channel 1 by omitting the whole SOURce node. It is because the channel 1 is the default channel for SOURce language node. On the other hand, if you want to refer to channel 2, "SOURce2" or "SOUR2" must be used in the program line.

Colon (:)

It is used to separate key words of a command with the key words in next level. As shown below:

```
APPL:SIN 455E3,1.15,0.0
```

In this Example , APPLy command assigns a sine wave with frequency of 455 KHz, amplitude of 1.15 V and DC offset of 0.0 V.

Semicolon (;)

It is used to separate several commands in the same subsystem and can also minimize typing. For Example , to send the following command string:

```
TRIG:SOUR EXT; COUNT 10
```

has the same effect as sending the following two commands:

```
TRIG:SOUR EXT
TRIG:COUNT 10
```

Question mark (?)

You can insert question marks into a command to query current values of most Parameter. For Example , the following commands will trigger to set the count as 10:

```
TRIG:COUN 10
```

Then, you may query count value by sending the following command:

```
TRIG:COUN?
```

You may also query the allowable minimum or maximum count as follows:

```
TRIG:COUN?MIN
TRIG:COUN?MAX
```

Comma (,)

If a command requires several Parameter, then a comma must be used to separate adjacent Parameter.

Space

You must use blank characters, [TAB] or [Space] to separate Parameter with key words of commands.

Generic commands (*)

Execute functions like reset, self-inspection and status operation. Generic commands always start with an asterisk (*) and occupy 3 character sizes, including one or more Parameter. Key words of a command and the first parameter are separated by a space. Semicolon (;) can separate several commands as follows:

*RST; *CLS; *ESE 32; *OPC?

Command terminator

Command strings sent to the instrument must end with a <Newline> (<NL>) character. IEEE-488 EOI (End or Identify) information can be used as <NL> character to replace termination command string of <NL> character. It is acceptable to place one <NL> after a <Enter>. Termination of command string always resets current SCPI command path to root level.



NOTE

As for every SCPI message with one query sent to the instrument, the instrument will use a <NL> or newline sign (EOI) to terminate response of return. For Example , if "DISP:TEXT?" is sent, <NL> will be placed after the returned data string to terminate response. If an SCPI message includes several queries separated by semicolon (such as "DISP?;DISP:TEXT?"), <NL> will terminate response returned after response to the last query. In all cases, the program must read <NL> in response before another command is sent to the instrument, otherwise errors will be caused.

Colon (:)

It is used to separate key words of a command with the key words in next level. As shown below:

APPL:SIN 455E3,1.15,0.0

In this Example , APPLy command assigns a sine wave with frequency of 455 KHz, amplitude of 1.15 V and DC offset of 0.0 V.

Semicolon (;)

It is used to separate several commands in the same subsystem and can also minimize typing. For Example , to send the following command string:

TRIG:SOUR EXT; COUNT 10

has the same effect as sending the following two commands:

TRIG:SOUR EXT
TRIG:COUNT 10

Question mark (?)

You can insert question marks into a command to query current values of most Parameter. For Example , the following commands will trigger to set the count as 10:

TRIG:COUN 10

Then, you may query count value by sending the following command:

TRIG:COUN?

You may also query the allowable minimum or maximum count as follows:

TRIG:COUN?MIN
TRIG:COUN?MAX

Comma (,)

If a command requires several Parameter, then a comma must be used to separate adjacent Parameter.

Space

You must use blank characters, [TAB] or [Space] to separate Parameter with key words of commands.

Generic commands (*)

Execute functions like reset, self-inspection and status operation. Generic commands always start with an asterisk (*) and occupy 3 character sizes, including one or more Parameter. Key words of a command and the first parameter are separated by a space. Semicolon (;) can separate several commands as follows:

*RST; *CLS; *ESE 32; *OPC?

Command terminator

Command strings sent to the instrument must end with a <Newline> (<NL>) character. IEEE-488 EOI (End or Identify) information can be used as <NL> character to replace termination command string of <NL> character. It is acceptable to place one <NL> after a <Enter>. Termination of command string always resets current SCPI command path to root level.

NOTE

As for every SCPI message with one query sent to the instrument, the instrument will use a <NL> or newline sign (EOI) to terminate response of return. For Example , if "DISP:TEXT?" is sent, <NL> will be placed after the returned data string to terminate response. If an SCPI message includes several queries separated by semicolon (such as "DISP?;DISP:TEXT?"), <NL> will terminate response returned after response to the last query. In all cases, the program must read <NL> in response before another command is sent to the instrument, otherwise errors will be caused.

1.5 Data Type

SCPI language defines several data types used for program message and response messages.

- Numerical parameter

Commands requiring numerical Parameter support the notations of all common decimal notations, including optional signs, decimal points, scientific notation, etc. Special values of numerical Parameter are also acceptable, such as MIN, MAX and DEF. In addition, suffixes for engineering units can also be sent together with numerical Parameter (including M, k, m or u). If the command accepts only some specific values, the instrument will automatically round the input Parameter to acceptable values. The following commands require numerical Parameter of frequency value:

[SOURce[1|2]:]FREQuency:CENTer {<Frequency>|MINimum|MAXimum}

- Discrete parameter

Discrete Parameter are used for settings with limited number of programming values (such as IMMEDIATE, EXTERNAL or BUS). They can use short and long format like key words of commands. They may be expressed in both upper and lower case. The query response always returns uppercase Parameter in short format. The following commands require discrete Parameter in voltage unit:

```
[SOURce[1|2]:]VOLTage:UNIT {VPP|VRMS|DBM}
```

- Boolean parameter

Boolean Parameter refer to true or false binary conditions. In case of false conditions, the instrument will accept "OFF" or "0". In case of true conditions, the instrument will accept "ON" or "1". In query of Boolean settings, the instrument will always return "0" or "1". Boolean Parameter are required by the following commands:

```
DISPlay {OFF|0|ON|1}
```

- ASCII string Parameter

String Parameter may actually include all ASCII character sets. Character strings must start and end with paired quotation marks; and single quotation marks or double quotation marks are both allowed. Quotation mark separators may also act as one part of a string, they can be typed twice without any character added between them. String parameter is used in the following command:

```
DISPlay:TEXT <quoted string>
```

For Example , the following commands display message of "WAITING..." (without quotation marks) on the front panel of the instrument.

```
DISP:TEXT "WAITING..."
```

Single quotation marks may also be used to display the same message.

```
DISP:TEXT 'WAITING...'
```

1.6 Remote Operation

Please refer to user manual for detailed introductions of the remote interface connections. If the user want to change the settings of the instrument, for instance, the output setting value, the command SYST:REM must be sent to the instrument after finishing the connection between the instrument and PC

Chapter2 Example

Sample 1: Fixed mode

```
SYST:REM \n           // Entering remote mode

FUNC:MODE FIX \n      // Set to fixed output mode

FUNC:PRI VOLT \n      // Set to CV priority mode

VOLT 10 \n            // Set output voltage to 10V

CURR 2 \n             // Set the upper limit of output current to 2A

OUTP 1 \n             // Turn on the output

MEAS:ALL? \n          // Returns the actual output voltage, current and power of the power
supply.
```

Sample 2: List mode

```
SYST:REM \n           // Entering remote mode

FUNC:MODE LIST \n      // Set to List output mode

LIST:FUNC VOLT \n      // Set to CV priority mode in List mode

LIST:STEP:COUN 2 \n      // Set 2 STEPs

LIST:STEP:VOLT 1,10.00 \n // Set the voltage of Step 1 to 10V

LIST:STEP:CURR 1,2.5 \n  // Set the current of Step 1 to 2.5A

LIST:STEP:SLEW 1,1 \n   // Set the slope of Step 1 to 1 second

LIST:STEP:WIDT 1,2 \n   // Set the pulse width of Step 1 to 2 seconds

LIST:STEP:VOLT 2,15.00 \n // Set the voltage of Step 2 to 15V
```

```
LIST:STEP:CURR 2,3.5 \n // Set the current of Step 2 to 3.5A

LIST:STEP:SLEW 2,1 \n // Set the slope of Step 2 to 1 second

LIST:STEP:WIDT 2,2 \n // Set the pulse width of Step 2 to 2 seconds

LIST:REP 3 \n // Set the loop count of List to 3

LIST:SAVE 1 \n // Save List to address 1

LIST:REC 1 \n // Recall List

LIST ON \n // Running List, waiting to be triggered

OUTP 1 \n // Turn on the output

TRIG:SOUR BUS \n // Setting the Trigger Source to BUS

*TRG \n // Trigger List to run
```

Chapter3 SCPI Status Register

IT-N6900 series power records variable instrument status via three kinds of status register, the three kinds of registers are standard event register, query status register and status bytes register. Status byte register records the information of other status registers.

Event register is read only register, used to store the implementation status of the power, the data used in the event register latches in the form, once the data is stored, subsequent data will be completely ignored. Even cannot be changed by re-setting order (*RST) or equipment restart.

but if query the data in event register or send clear order *CLS (clear status), the event register will be automatically cleared. The main content which the standard event register records is:

Whether power output is turned on, order syntax errors, order execution errors, self-test or calibration errors, query errors and so on.

Bit	Decimal Value	Definition	
0	OPC	1	Operation Complete. All commands prior to and including an *OPC command have been executed.
1	Not Used	0	Always set to 0.
2	QYE	4	Query Error. The power supply tried to read the output buffer but it was empty. Or, new command line was received before a previous query had been read. Or, both the input and output buffers are full.
3	DDE	8	Device Error. A self-test or calibration error occurred (see error numbers 601 through 750 in chapter 5).
4	EXE	16	Execution Error. An execution error occurred (see error numbers -211 through -224 in chapter 5).
5	CME	32	Command Error. A command syntax error occurred (see error numbers -101 through -178 in chapter 5).
6	Not Used	0	Always set to 0.
7	PON	128	Power On. Power has been turned off and on since the last time the event register was read or cleared

Query status register provide some information of the power, such as over voltage, over temperature, over current, and so on.

Bit	Decimal Value	Definition	
0	Over Voltage Protect	1	Over Voltage Protect
1	Over Current Protect	2	Over Current Protect
2	Over Power Protect	4	Over Power Protect

3	Under Voltage Protect	8	Under Voltage Protect
4	Over Temperature Protect	16	Over Temperature Protect
5	Under Current Protect	32	Under Current Protect
6	Sense Err	64	Sense error
7	Foldback Protect	128	Foldback Protect
8	Front Over Current Protect	256	Front Over Current Protect
9	Front Under Current Protect	512	Front Under Current Protect
10	ACDown	1024	AC input power failure
11	RangeFail	2048	Range switching failure
12	Bridge	4096	Bridge
13	Inhibit Protect	8192	Inhibit Protect

Status byte register records the information of other registers. The query data is temporally stored in the output buffer of the power supply, and feedback to customer through BIT4 bit. The data bits in Status byte group will not be latched, when the information in event register is changed, the corresponding bit in status byte register will subsequently be changed.

Bit	Decimal Value	Definition	
0-1	Not used	0	Always set to 0.
2	EAV	4	Error buffer available
3	QUES	8	One or more bits are set in the questionable status register (bits must be “enabled” in the enable register).
4	MAV	16	Data is available in the power supply output buffer.
5	ESB	32	One or more bits are set in the standard event register (bits must be “enabled” in the enable register).
6	RQS	64	The power supply is requesting service (serial poll).
7	Not used	0	Always set to 0.

The below picture will give you more detailed information:

Questionable Status

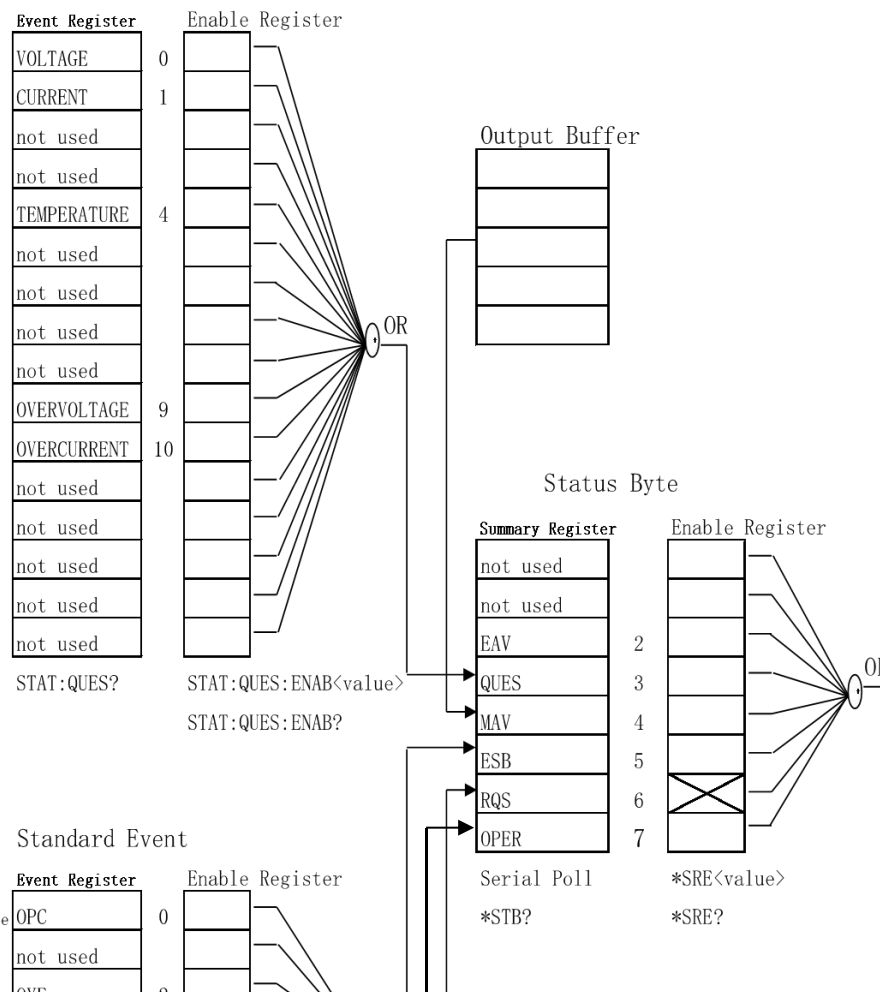

Standard Event

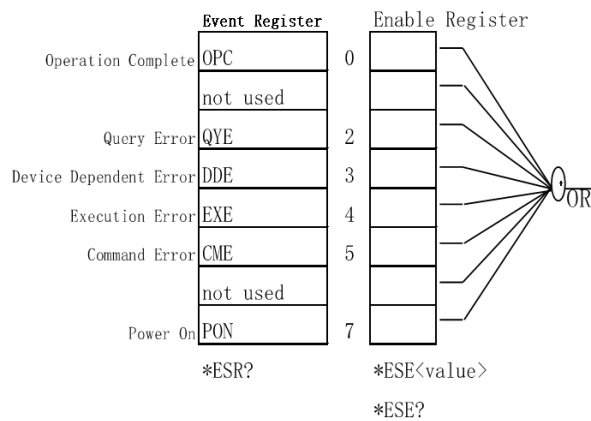

Operate Event

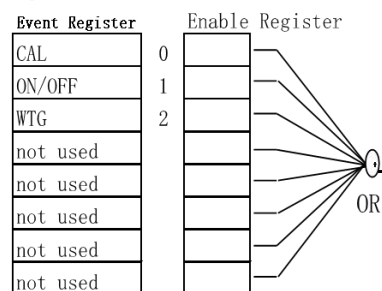

Chapter4 STATus Subsystem

STATus:QUEStionable[:EVENT]?

This command is used to read the value of the query event register. After this command is executed, the value of the query event register is cleared.

Query Syntax

STATus:QUEStionable[:EVENT]?

Parameter

None

Return Parameters

<NR2>

Related Command

STATus:QUEStionable:ENABLE

STATus:QUEStionable:ENABLE <state>

The command edits the value of the Query Event Enable Register. The programming parameter determines which bits in the Query Event Register are 1, which will make QUES in the Status Register to be 1.

Command Syntax

STATus:QUEStionable:ENABLE <state>

Parameter

0~65535 (Parameter range is related to the definition of query event enable register.)

PowerOn Value

Refer to the *PSC command.

Example

STATus:QUEStionable:ENABLE 128

Query Syntax

STATus:QUEStionable:ENABLE?

Return Parameters

<NR2>

STATus:QUEStionable:PTRansition <NR1>

Sets the value of the PTR (Positive-Transition) registers. These registers serve as a polarity filter between the Questionable Condition and Questionable Event registers. When a bit in the PTR register is set to 1, then a 0-to-1 transition of the corresponding bit in the Questionable Condition register causes that bit in the Questionable Event register to be set. STATus:PRESet sets all bits in the PTR registers and clears all bits in the NTR registers.

Subsystem

STATus

Command Syntax

STATus:QUEStionable:PTRansition <NR1>

Parameter

<NR1>

A decimal value corresponding to the binary weighted sum of the register's bits. Setting range: 0 to 65535.

Default Value

0

Example

Enable bit 3 and 4 in the questionable PTR register: STATus:QUEStionable:PTRansition 24

Return Parameters

<NR1>

STATus:QUEStionable:NTRansition <NR1>

Sets the value of the NTR (Negative-Transition) registers. These registers serve as a polarity filter between the Questionable Condition and Questionable Event registers. When a bit in the NTR register is set to 1, then a 1-to-0 transition of the corresponding bit in the Questionable Condition register causes that bit in the Questionable Event register to be set. **STATus:PRESet** sets all bits in the PTR registers and clears all bits in the NTR registers.

If the same bits in both NTR and PTR registers are set to 1, then any transition of that bit at the Questionable Condition register sets the corresponding bit in the Questionable Event register.

If the same bits in both NTR and PTR registers are set to 0, then no transition of that bit at the Questionable Condition register can set the corresponding bit in the Questionable Event register.

The value returned is the binary-weighted sum of all enabled bits in the register.

Subsystem

STATus

Command Syntax

STATus:QUEStionable:NTRansition <NR1>

Parameter

<NR1>

A decimal value corresponding to the binary weighted sum of the register's bits. Setting range: 0 to 65535.

Default Value

0

Example

Enable bit 3 and 4 in the questionable NTR register: STATus:QUEStionable:NTRansition 24

Query Syntax

STATus:QUEStionable:NTRansition?

Return Parameters

<NR1>

STATus:QUEStionable:CONDition?

Queries the condition register for the Questionable Status group. This is a read-only register, which holds the live (unlatched) operational status of the instrument. Reading the Questionable Status Condition register does not clear it.

Query Syntax

STATus:QUEStionable:CONDition?

Parameter

None

Return Parameters

<NR2>

STATus:OPERation[:EVENT]?

Queries the event register for the Operation Status group. This is a read-only register, which stores (latches) all events that are passed by the Operation NTR and/or PTR filter. Reading the Operation Status Event register clears it.

Query Syntax

STATus:OPERation[:EVENT]?

Parameter

None

Return Parameters

<NR1>

Related Command

STATus:OPERation:ENABLE

STATus:OPERation:CONDition?

Queries the condition register for the Operation Status group. This is a read-only register, which holds the live (unlatched) operational status of the instrument. Reading the Operation Status Condition register does not clear it.

- The value returned is the binary-weighted sum of all enabled bits in the register. For Example , with bit 3 (value 8) and bit 5 (value 32) set and enabled, the query returns +40.
- The condition register bits reflect the current condition. If a condition goes away, the corresponding bit is cleared.
- *RST clears this register, other than those bits where the condition still exists after *RST.

Query Syntax

STATus:OPERation:CONDition?

Parameter

None

Return Parameters

<NR1>

STATus:OPERation:ENABLE

Sets the value of the enable register for the Operation Status group. The enable register is a mask for enabling specific bits from the Operation Event register to set the OPER (operation summary) bit of the Status Byte register. **STATus:PRESet** clears all bits in the enable register. ***CLS** does not clear the enable register, but does clear the event register.

Command Syntax

STATus:OPERation:ENABLE <NR1>

Parameter

0~65535

Example

STATus:OPERation:ENABLE 128

Query Syntax

STATus:OPERation:ENABLE?

Return Parameters

<NR1>

STATus:OPERation:PTRansition <NR1>

Sets the value of the PTR (Positive-Transition) registers. These registers serve as a polarity filter between the Operation Condition and Operation Event registers. When a bit in the PTR register is set to 1, then a 0-to-1 transition of the corresponding bit in the Operation Condition register causes that bit in the Operation Event register to be set. **STATus:PRESet** sets all bits in the PTR registers and clears all bits in the NTR registers.

Subsystem

STATus

Command Syntax

STATus:OPERation:PTRansition <NR1>

Parameter

<NR1>

A decimal value corresponding to the binary weighted sum of the register's bits. Setting range: 0 to 65535.

Default Value

0

Example

Enable bit 3 and 4 in the PTR register: STATus:OPERation:PTRansition 24

Query Syntax

STATus:OPERation:PTRansition?

Return Parameters

<NR1>

STATus:OPERation:NTRansition <NR1>

Sets the value of the NTR (Negative-Transition) registers. These registers serve as a polarity filter between the Operation Condition and Operation Event registers. When a bit in the NTR register is set to 1, then a 1-to-0 transition of the corresponding bit in the Operation Condition register causes that bit in the

Operation Event register to be set. **STATus:PRESet** sets all bits in the PTR registers and clears all bits in the NTR registers.

- If the same bits in both NTR and PTR registers are set to 1, then any transition of that bit at the Operation Condition register sets the corresponding bit in the Operation Event register.
- If the same bits in both NTR and PTR registers are set to 0, then no transition of that bit at the Operation Condition register can set the corresponding bit in the Operation Event register.
- The value returned is the binary-weighted sum of all enabled bits in the register.

Subsystem

STATus

Command Syntax

STATus:OPERation:NTRansition <NR1>

Parameter

<NR1>

A decimal value corresponding to the binary weighted sum of the register's bits. Setting range: 0 to 65535.

Default Value

0

Example

Enable bit 3 and 4 in the NTR register: STATus:OPERation:NTRansition 24

Query Syntax

STATus:OPERation:NTRansition?

Return Parameters

<NR1>

STATus:PRESet

Presets all Enable, PTR, and NTR registers.

Operation register	Questionable register	Preset setting
STAT:OPER:ENAB	STAT:QUES:ENAB	All defined bits are disabled

STAT:OPER:NTR	STAT:QUES:NTR	All defined bits are disabled
STAT:OPER:PTR	STAT:QUES:PTR	All defined bits are enabled

Command Syntax

STATus:PRESet

Parameter

None

Chapter5 System Subsystem

SYSTem:BEEPer[:IMMediate]

This command tests the buzzer function of the power supply. If it passes the test, a beep sounds.

Command Syntax

SYSTem:BEEPer[:IMMediate]

Parameter

None

RST Value

Not applicable

Example

SYST:BEEP

Query Syntax

None

Return Parameters

None

SYSTem:BEEPer:STATe <BOOL>

This command is used to set the state of the buzzer.

Command Syntax

SYSTem:BEEPer:STATe <BOOL>

Parameter

0|OFF|1|ON

RST Value

Not applicable

Example

SYST:BEEP:STAT 0

Query Syntax

SYSTem:BEEPer:STATe?

Return Parameters

0|1

SYSTem:VERSion?

This command is used to return the version number of the SCPI command.

Command Syntax

SYSTem:VERSion?

Parameter

None

RST Value

Not applicable

Example

- > SYST:VERS?
< - "1993.1"



Note

- ◆ “- >” indicates the commands that you send to the power supply.
- ◆ “< -” indicates the response from the power supply.

Return Parameters

SRD

SYSTem:ERRor[:NEXT]?

This command is used to return the error code and error description of the next entry.

Command Syntax

SYSTem:ERRor[:NEXT]?

Parameter

None

RST Value

Not applicable

Example

- > SYST:ERR?
< - 0, "No error"



Note

- ◆ “- >” indicates the commands that you send to the power supply.
- ◆ “< -” indicates the response from the power supply.

Return Parameters

SRD

SYSTem:REMOte

This command is used to set the instrument to remote status.

Command Syntax

SYSTem:REMOte

Parameter

None

RST Value

Not applicable

Example

SYST:REM

Query Syntax

SYSTem:REMOte?

Return Parameters

0|1

SYSTem:LOCAl

This command is used to set the instrument to the local state.

Command Syntax

SYSTem:LOCAl

Parameter

None

RST Value

Not applicable

Example

SYST:LOC

Query Syntax

None

SYSTem:RWLock

This command locks the power supply in the remote control mode. When this command is executed, pressing the LOCAL keys cannot switch the instrument to the local control mode.

Command Syntax

SYSTem:RWLock

Parameter

None

RST Value

Not applicable

Example

SYST:RWL

Query Syntax

None

SYSTem:KEY <NR1>

This command enters a key value (the maximum value is the number of front panel keys).

Command Syntax

SYSTem:KEY < NR1>

Parameter

Parameter	Key	Parameter	Key
1	Local	10	Recall
2	Shift	11	Enter
5	On/Off	12	Left
6	V-set	13	Right
7	Save	14	Decrease
8	Esc	15	Increase
9	I-set	-	-

<1-29>

RST Value

Not applicable

Example

SYST:KEY 1

Query Syntax

SYSTem:KEY?

Return Parameters

NR1

SYSTem:REBoot

This command is used to perform an instrument reboot.

Command Syntax

SYSTem:REBoot

Parameter

None

RST Value

Not applicable

Example

SYST:REB

Query Syntax

None

SYSTem:COMMunicate:LAN:CURRent:ADDRess <SPD>

This command is used to set the IP address of the device.

Command Syntax

SYSTem:COMMunicate:LAN:CURRent:ADDRess <SPD>

Parameter

"<0-255>,<0-255>,<0-255>,<0-255>"

RST Value

Not applicable

Example

SYST:COMM:LAN:CURR:ADDR "192.168.0.201"

Query Syntax

SYSTem:COMMunicate:LAN:CURRent:ADDRess?

Return Parameters

<SRD>

SYSTem:COMMunicate:LAN:CURRent:DGATeway <SPD>

This command is used to set the gateway of the device.

Command Syntax

SYSTem:COMMunicate:LAN:CURRent:DGATeway <SPD>

Parameter

<0-255>,<0-255>,<0-255>,<0-255>"

RST Value

Not applicable

Example

SYST:COMM:LAN:CURR:DGAT "192.168.0.1"

Query Syntax

SYSTem:COMMunicate:LAN:CURRent:DGATeway?

Return Parameters

<SRD>

SYSTem:COMMunicate:LAN:CURRent:SMASK <SPD>

This command is used to set the subnet mask of the device.

Command Syntax

SYSTem:COMMunicate:LAN:CURRent:SMASK <SPD>

Parameter

"<0-255>,<0-255>,<0-255>,<0-255>"

RST Value

Not applicable

Example

SYST:COMM:LAN:CURR:SMAS "255.255.255.0"

Query Syntax

SYSTem:COMMunicate:LAN:CURRent:SMASK?

Return Parameters

<SRD>

SYSTem:COMMunicate:LAN:DHCP <BOOL>

This command is used to turn on the dynamic IP or not.

Command Syntax

SYSTem:COMMunicate:LAN:DHCP <BOOL>

Parameter

<0|OFF|1|ON>

RST Value

Not applicable

Example

SYST:COMM:LAN:DHCP 1

Query Syntax

SYSTem:COMMunicate:LAN:DHCP?

Return Parameters

0|1

SYSTem:COMMunicate:LAN:SOCKetport <NR1>

This command is used to set the port number for network communication.

Command Syntax

SYSTem:COMMunicate:LAN:SOCKetport <NR1>

Parameter

<2000-65535>

RST Value

Not applicable

Example

SYST:COMM:LAN:SOCK 30000

Query Syntax

SYSTem:COMMunicate:LAN:SOCKetport?

Return Parameters

NR1

SYSTem:COMMunicate:LAN:MACaddress?

This command is used to return the MAC address of the communication.

Command Syntax

SYSTem:COMMunicate:LAN:MACaddress?

Parameter

None

RST Value

Not applicable

Example

```
- > SYST:COMM:LAN:MAC?  
< - "12:34:56:79:99:AA"
```



Note

- ◆ “ - >” indicates the commands that you send to the power supply.
- ◆ “ < - ” indicates the response from the power supply.

Return Parameters

SRD

SYSTem:COMMunicate:SERial:BAUDrate

This command is used to set the baud rate of serial port.

Command Syntax

```
SYSTem:COMMunicate:SERial:BAUDrate
```

Parameter

```
<4800|9600|19200|38400|57600|115200>
```

RST Value

Not applicable

Example

```
SYST:COMM:SER:BAUD 9600
```

Query Syntax

```
SYSTem:COMMunicate:SERial:BAUDrate?
```

Return Parameters

```
4800|9600|19200|38400|57600|115200
```

SYSTem:COMMunicate:LAN:DNS1 <SPD>

This command is used to set the DNS1 address (preferred) of the LAN.

Command Syntax

```
SYSTem:COMMunicate:LAN:DNS1 <SPD>
```

Parameter

```
"<0-255>,<0-255>,<0-255>,<0-255>"
```

RST Value

Not applicable

Example

```
SYST:COMM:LAN:DNS1 "192.168.0.1"
```

Query Syntax

SYSTem:COMMunicate:LAN:DNS1?

Return Parameters

<SRD>

SYSTem:COMMunicate:LAN:DNS2 <SPD>

This command is used to set the DNS2 address (alternate) of the LAN.

Command Syntax

SYSTem:COMMunicate:LAN:DNS2 <SPD>

Parameter

"<0-255>,<0-255>,<0-255>,<0-255>"

RST Value

Not applicable

Example

SYST:COMM:LAN:DNS1 "192.168.0.2"

Query Syntax

SYSTem:COMMunicate:LAN:DNS2?

Return Parameters

<SRD>

SYSTem:COMMunicate:LAN:RESTore

This command is used to restore the factory default configuration of the LAN.

Command Syntax

SYSTem:COMMunicate:LAN:RESTore

Parameter

None

RST Value

Not applicable

Example

SYST:COMM:LAN:REST

Query Syntax

None

Return Parameters

None

SYSTem:COMMunicate:LAN:SAVE

This command is used for LAN configuration confirmation.

Command Syntax

SYSTem:COMMunicate:LAN:SAVE

Parameter

None

RST Value

Not applicable

Example

SYST:COMM:LAN:SAVE

Query Syntax

None

Return Parameters

None

SYSTem:COMMunicate:LAN:STATe?

This command is used to query the status of LAN.

Command Syntax

SYSTem:COMMunicate:LAN:STATe?

Parameter

None

RST Value

Not applicable

Example

SYST:COMM:LAN:STAT?

Return Parameters

DOWN|UP

SYSTem:COMMunicate:LAN:HOSTname?

This command is used to query the host name.

Command Syntax

SYSTem:COMMunicate:LAN:HOSTname?

Parameter

None

RST Value

Not applicable

Example

SYST:COMM:LAN:HOST?

Return Parameters

SRD

SYSTem:COMMunicate:LAN:DESCription?

This command is used to query the host description string.

Command Syntax

SYSTem:COMMunicate:LAN:DESCription?

Parameter

None

RST Value

Not applicable

Example

SYST:COMM:LAN:DESC?

Return Parameters

SRD

SYSTem:COMMunicate:GPIB:RDEVice:ADDRess <addr>

This command is used to set the GPIB address of the device.

Command Syntax

SYSTem:COMMunicate:GPIB:RDEVice:ADDRess <addr>

Parameter

<NR1>

<1-30>

RST Value

Not applicable

Example

SYST:COMM:GPIB:RDEV:ADDR 14

Query Syntax

SYSTem:COMMunicate:GPIB:RDEVice:ADDRess?

Return Parameters

<NR1>

SYSTem:BRIGhtness <NR1>

This command is used to set the screen brightness of power supply, the setting range is 10-100.

Command Syntax

SYSTem:BRIGhtness <NR1>

Parameter

<10-100>

Example

SYST:BRIG 100

Query Syntax

SYSTem:BRIGhtness?

Return Parameters

<NR1>

Chapter6 SENSe Subsystem

SENSe[:REMOte][:STATe] <BOOL>

This command is used to set the Sense enable state.

Command Syntax

SENSe[:REMOte][:STATe] <BOOL>

Parameter

0|OFF|1|ON

RST Value

None

Example

SENS ON

Query Syntax

SENSe[:REMOte][:STATe]?

Return Parameters

0|1

SENSe:FILTer:LEVel <SLOW|MEDIum|FAST>

This command is used to set the Sense filtering level.

Command Syntax

SENSe:FILTer:LEVel <SLOW|MEDIum|FAST>

Parameter

<CPD>

SLOW|MEDIum|FAST

RST Value

None

Example

SENS:FILT:LEV MED

Query Syntax

SENSe:FILTer:LEVel?

Return Parameters

SLOW|MED|FAST

Chapter7 TRIGger Subsystem

TRIGger[:IMMediate]

This command is used to generate a trigger signal. When the power trigger source is in command trigger (BUS) mode, this command will generate a trigger signal. Same function as *TRG command.

Command Syntax

TRIGger[:IMMediate]

Parameter

None

Related Command

*TRG TRIG:SOUR

TRIGger:SOURce <MANUal|BUS|EXTernal>

This command is used to select the source of the trigger signal. The power supply can receive a trigger signal from the panel (panel Trigger key) or receive a bus trigger signal or external level signal. The trigger source is not reset when the *RST command is executed.

Command Syntax

TRIGger:SOURce <MANUal|BUS|EXTernal>

Parameter

MANUal|BUS|EXTernal

Query Syntax

TRIGger:SOURce?

TRIGger:EXTernal:DIRection <IN|OUT>

The command sets the signal direction of the external trigger pin. The trigger direction is not reset when the *RST command is executed.

IN: Receive the trigger signal.

OUT: Output the trigger signal.

Command Syntax

TRIGger:EXTernal:DIRection <IN|OUT>

Parameter

IN|OUT

Query Syntax

TRIGger:EXternal:DIRection?

Chapter8 OUTPut Subsystem

OUTPut[:STATe][:ALL] <BOOL>

This command is used to set the output state of the power supply.

Command Syntax

OUTPut[:STATe][:ALL] <BOOL>

Parameter

0|OFF|1|ON

RST Value

0.000

Example

OUTP ON

Query Syntax

OUTPut[:STATe][:ALL]?

Return Parameters

0|1

OUTPut:PROTection:CLEAr

This command is used to clear the protection.

Command Syntax

OUTPut:PROTection:CLEAr

Parameter

None

Example

OUTP:PROT:CLE

Query Syntax

None

OUTPut:DELAy[:ON] <NRf+>

This command is used to set the delay time for the power output to turn on.

Command Syntax

OUTPut:DELAy[:ON] <NRf+>

Parameter

<0.000-10.000>

RST Value

0.000

Example

OUTP:DEL 1.0

Query Syntax

OUTPut:DELAy[:ON]? [MINimum|MAXimum]

Return Parameters

NRf

OUTPut:DELAy:OFF <NRf+>

This command is used to set the delay time for the power output to be turned off.

Command Syntax

OUTPut:DELAy:OFF <NRf+>

Parameter

<0.000-10.000>

RST Value

0.000

Example

OUTP:DEL:OFF 1.0

Query Syntax

OUTPut:DELAy:OFF? [MINimum|MAXimum]

Return Parameters

NRf

OUTPut:TIMer[:STATe] <BOOL>

This command sets the timer function to turn on or off.

Command Syntax

OUTPut:TIMer[:STATe] <BOOL>

Parameter

0|OFF|1|ON

RST Value

0

Example

OUTP:TIM ON

Query Syntax

OUTPut:TIMer[:STATe]?

Return Parameters

0|1

OUTPut:TIMer:DELay <NRf+>

This command sets the time of the timer.

Command Syntax

OUTPut:TIMer:DELay <NRf+>

Parameter

< 1.0-9999>

RST Value

1.0

Example

OUTP:TIM:DEL 3600

Query Syntax

OUTPut:TIMer:DELay? [MINimum|MAXimum]

Return Parameters

NRf

OUTPut:PROTection:FOLDback[:MODE] <OFF|CC|CV>

This command is used to set the FOLDBACK protection mode.

Command Syntax

OUTPut:PROTection:FOLDback[:MODE] <OFF|CC|CV>

Parameter

<OFF|CC|CV>

RST Value

OFF

Example

OUTP:PROT:FOLD CC

Query Syntax

OUTPut:PROTection:FOLDback[:MODE]?

Return Parameters

OFF|CC|CV

OUTPut:PROTection:FOLDback:DELay <NRf+>

This command is used to set the FOLDBACK protection delay time.

Command Syntax

OUTPut:PROTection:FOLDback:DELay <NRf+>

Parameter

<0.00-10.00>

RST Value

0.0000

Example

OUTP:PROT:FOLD:DEL 1

Query Syntax

OUTPut:PROTection:FOLDback:DELay? [MINimum|MAXimum]

Return Parameters

NRf

OUTPut:PONSetup[:STATe] <RST|LAST|LOFF>

This command is used to set the instrument power-up Parameter or power-up output status.

RST: Restore to factory settings after power up.

LAST: The Parameter settings and output status after power-up are the settings before power-down.

LOFF: The Parameter setting after power-on is the setting before power-off, and the output state is OFF.

Command Syntax

OUTPut:PONSetup[:STATe] <RST|LAST|LOFF>

Parameter

<RST|LAST|LOFF>

Example

OUTP:PONS LAST

Query Syntax

OUTPut:PONSetup[:STATe]?

Return Parameters

RST|LAST|LOFF

OUTPut:INHibit:MODE <OFF|LIVing|LATCh>

Set the INHibit mode.

OFF: The output state is not controlled by the rear panel INHibit pin.

LIVing: When a low signal is received at the rear panel INHibit pin, output is disabled, and when a high signal is received, output is resumed.

LATCh: When the rear panel Inhibit pin receives a low level signal to shut down the output, generating output inhibit protection, recovery requires the Inhibit pin to receive a high level signal and perform a clear protection operation (manually press the front panel key esc), and then press the front panel output key [On/Off] to restore the output.

Command Syntax

OUTPut:INHibit:MODE <OFF|LIVing|LATCh>

Parameter

<OFF|LIVing|LATCh>

RST Value

OFF

Example

OUTP:INH:MODE LATC

Query Syntax

OUTPut:INHibit:MODE?

Return Parameters

OFF|LIV|LATC

Chapter9 SOURce Subsystem

[SOURce:]CURRent[:LEVel][:IMMediate][:AMPLitude] <NRf+>

This command is used to set the output current of the power supply.

Command Syntax

[SOURce:]CURRent[:LEVel][:IMMediate][:AMPLitude] <NRf+>

Parameter

<MINimum-MAXimum|MINimum|MAXimum>

RST Value

Machine rated current

Example

CURR 3.500

Query Syntax

[SOURce:]CURRent[:LEVel][:IMMediate][:AMPLitude]? [MINimum|MAXimum]

Return Parameters

NRf

[SOURce:]CURRent[:LEVel]:TRIGgered[:AMPLitude] <NRf+>

This command sets the output current when the power supply is triggered.

Command Syntax

[SOURce:]CURRent[:LEVel]:TRIGgered[:AMPLitude] <NRf+>

Parameter

<MINimum-MAXimum|MINimum|MAXimum>

RST Value

Machine rated current

Example

CURR:TRIG 3.500

Query Syntax

[SOURce:]CURRent[:LEVel]:TRIGgered[:AMPLitude]? [MINimum|MAXimum]

Return Parameters

NRf

**[SOURce:]CURRENT:OVER:PROTECTION[:LEVEL]
<NRf+>**

This command sets the power supply output overcurrent protection limit.

Command Syntax

[SOURce:]CURRENT:OVER:PROTECTION[:LEVEL] <NRf+>

Parameter

<MINimum-MAXimum|MINimum|MAXimum>

RST Value

Current Setting Maximum Value

Example

CURR:OVER:PROT 3.500

Query Syntax

[SOURce:]CURRENT:OVER:PROTECTION[:LEVEL]? [MINimum|MAXimum]

Return Parameters

NRf

[SOURce:]CURRENT:OVER:PROTECTION:DELAY <NRf+>

This command sets the power supply output overcurrent protection delay time.

Command Syntax

[SOURce:]CURRENT:OVER:PROTECTION:DELAY <NRf+>

Parameter

<NRf+>

<0.00-10.00>

RST Value

10.00

Example

CURR:OVER:PROT:DEL 10.00

Query Syntax

[SOURce:]CURRENT:OVER:PROTECTION:DELAY? [MINimum|MAXimum]

Return Parameters

NRf

**[SOURce:]CURRENT:OVER:PROTECTION:STATE
<BOOL>**

This command sets the power supply output overcurrent protection status.

Command Syntax

`[SOURce:]CURRENT:OVER:PROTECTION:STATE <BOOL>`

Parameter

0|OFF|1|ON

RST Value

0

Example

`CURR:OVER:PROT:STAT ON`

Query Syntax

`[SOURce:]CURRENT:OVER:PROTECTION:STATE?`

Return Parameters

0|1

**[SOURce:]CURRENT:UNDER:PROTECTION[:LEVEL]
<NRf+>**

This command sets the power supply output undercurrent protection limit.

Command Syntax

`[SOURce:]CURRENT:UNDER:PROTECTION[:LEVEL] <NRf+>`

Parameter

`<MINimum-MAXimum|MINimum|MAXimum>`

RST Value

0.000

Example

`CURR:UND:PROT 0.500`

Query Syntax

`[SOURce:]CURRENT:UNDER:PROTECTION[:LEVEL]? [MINimum|MAXimum]`

Return Parameters

<NRf>

**[SOURce:]CURRent:UNDer:PROTection:DELay
<NRf+>**

This command sets the power supply output undercurrent protection delay time.

Command Syntax

`[SOURce:]CURRent:UNDer:PROTection:DELay <NRf+>`

Parameter

<NRf+>

0.00-10.00

RST Value

10.00

Example

`CURR:UND:PROT:DEL 10.000`

Query Syntax

`[SOURce:]CURRent:UNDer:PROTection:DELay? [MINimum][MAXimum]`

Return Parameters

<NRf>

**[SOURce:]CURRent:UNDer:PROTection:STATe
<BOOL>**

This command sets the power supply output undercurrent protection status.

Command Syntax

`[SOURce:]CURRent:UNDer:PROTection:STATe <BOOL>`

Parameter

<0|OFF|1|ON>

RST Value

0

Example

`CURR:UND:PROT:STAT ON`

Query Syntax

`[SOURce:]CURRent:UNDer:PROTection:STATe?`

Return Parameters

0|1

**[SOURce:]CURRent:UNDer:PROTection:WARM
<NRf+>**

This command sets the warm-up time for power supply output undercurrent protection.

Command Syntax

`[SOURce:]CURRent:UNDer:PROTection:WARM <NRf+>`

Parameter

<0.00-30.00>

RST Value

30.00

Example

`CURR:UND:PROT:WARM 10.000`

Query Syntax

`[SOURce:]CURRent:UNDer:PROTection:WARM? [MINimum|MAXimum]`

Return Parameters

NRf

[SOURce:]CURRent:SLEW[:BOTH] <NRf+>

This command is used to set the power supply output current rise and fall slopes simultaneously.

Command Syntax

`[SOURce:]CURRent:SLEW[:BOTH] <NRf+>`

Parameter

<MINimum-MAXimum|MINimum|MAXimum>

RST Value

0.030

Example

`CURR:SLEW 0.030`**[SOURce:]CURRent:SLEW:NEGative <NRf+>**

This command sets the current down slope of the power supply output.

Command Syntax

[SOURce:]CURRent:SLEW:NEGative <NRf+>

Parameter

<MINimum-MAXimum|MINimum|MAXimum>

RST Value

0.030

Example

CURR:SLEW:NEG 0.030

Query Syntax

[SOURce:]CURRent:SLEW:NEGative? [MINimum|MAXimum]

Return Parameters

NR3

[SOURce:]CURRent:SLEW:POSitive <NRf+>

This command sets the current rise slope of the power supply output.

Command Syntax

[SOURce:]CURRent:SLEW:POSitive <NRf+>

Parameter

<MINimum-MAXimum|MINimum|MAXimum>

RST Value

0.030

Example

CURR:SLEW:POS 1.000

Query Syntax

[SOURce:]CURRent:SLEW:POSitive? [MINimum|MAXimum]

Return Parameters

NR3

[SOURce:]CURRent:DECimal?

The command returns the number of decimal places of the current value.

Command Syntax

[SOURce:]CURRent:DECimal?

Parameter

None

Example

CURR:DEC?

Return Parameters

<NR1>

[SOURce:]CURRent:RANGe <AUTO|HIGH|LOW>

This command sets the current measurement gear of the power supply.

Command Syntax

[SOURce:]CURRent:RANGe <AUTO|HIGH|LOW>

Parameter

<AUTO|HIGH|LOW>

RST Value

AUTO

Example

CURR:RANG LOW

Query Syntax

[SOURce:]CURRent:RANGe?

Return Parameters

AUTO|HIGH|LOW

[SOURce:]CURRent[:LEVeI]:LIMit[:HIGH] <NRf+>

This command sets the upper limit of current output.

The current current is greater than the upper limit, it will synchronously modify the current current value to the maximum output upper limit value.

Command Syntax

[SOURce:]CURRent[:LEVeI]:LIMit[:HIGH] <NRf+>

Parameter

<MINimum-MAXimum|MINimum|MAXimum>

RST Value

MAXimum

Example

CURR:LIM 25

Query Syntax

[SOURce:]CURRent[:LEVel]:LIMit[:HIGH]? [MINimum|MAXimum]

Return Parameters

<NRf>

[SOURce:]VOLTage[:LEVel][:IMMediate][:AMPLitude] <NRf+>

This command sets the power supply output voltage.

Command Syntax

[SOURce:]VOLTage[:LEVel][:IMMediate][:AMPLitude] <NRf+>

Parameter

<MINimum-MAXimum|MINimum|MAXimum>

RST Value

0.00

Example

VOLT 60.00

Query Syntax

[SOURce:]VOLTage[:LEVel][:IMMediate][:AMPLitude]? [MINimum|MAXimum]

Return Parameters

NRf

[SOURce:]VOLTage[:LEVel]:TRIGgered[:AMPLitude] <NRf+>

This command sets the output voltage when the power supply is triggered.

Command Syntax

[SOURce:]VOLTage[:LEVel]:TRIGgered[:AMPLitude] <NRf+>

Parameter

<MINimum-MAXimum|MINimum|MAXimum>

RST Value

0.00

Example

VOLT:TRIG 60.00

Query Syntax

[SOURce:]VOLTage[:LEVel]:TRIGgered[:AMPLitude]? [MINimum|MAXimum]

Return Parameters

NRf

[SOURce:]VOLTage:SLEW[:BOTH] <NRf+>

This command is used to set the power supply voltage rise and fall slopes simultaneously.

Command Syntax

[SOURce:]VOLTage:SLEW[:BOTH] <NRf+>

Parameter

<MINimum-MAXimum|MINimum|MAXimum>

RST Value

0.030

Example

VOLT:SLEW 0.03

[SOURce:]VOLTage:SLEW:NEGative <NRf+>

This command sets the power supply voltage drop slope.

Command Syntax

[SOURce:]VOLTage:SLEW:NEGative <NRf+>

Parameter

<MINimum-MAXimum|MINimum|MAXimum>

RST Value

0.030

Example

VOLT:SLEW:NEG 0.03

Query Syntax

[SOURce:]VOLTage:SLEW:NEGative? [MINimum|MAXimum]

Return Parameters

NRf

[SOURce:]VOLTage:SLEW:POSitive <NRf+>

This command sets the power supply voltage rise slope.

Command Syntax

[SOURce:]VOLTage:SLEW:POSitive <NRf+>

Parameter

<MINimum-MAXimum|MINimum|MAXimum>

RST Value

0.030

Example

VOLT:SLEW:POS 0.03

Query Syntax

[SOURce:]VOLTage:SLEW:POSitive? [MINimum|MAXimum]

Return Parameters

NRf

[SOURce:]VOLTage:OVER:PROTection[:LEVel] <NRf+>

This command sets the power overvoltage protection limit.

Command Syntax

[SOURce:]VOLTage:OVER:PROTection[:LEVel] <NRf+>

Parameter

<MINimum-MAXimum|MINimum|MAXimum>

RST Value

Voltage Setting Maximum

Example

VOLT:OVER:PROT 60.00

Query Syntax

[SOURce:]VOLTage:OVER:PROTection[:LEVel]? [MINimum|MAXimum]

Return Parameters

NRf

[SOURce:]VOLTage:OVER:PROTection:DElay <NRf+>

This command sets the delay time for power overvoltage protection.

Command Syntax

[SOURce:]VOLTage:OVER:PROTection:DELay <NRf+>

Parameter

<0.00-10.00>

RST Value

10.00

Example

VOLT:OVER:PROT:DEL 10.00

Query Syntax

[SOURce:]VOLTage:OVER:PROTection:DELay? [MINimum|MAXimum]

Return Parameters

NRf

[SOURce:]VOLTage:OVER:PROTection:STATe <BOOL>

This command sets the power overvoltage protection status.

Command Syntax

[SOURce:]VOLTage:OVER:PROTection:STATe <BOOL>

Parameter

0|OFF|1|ON

RST Value

0

Example

VOLT:OVER:PROT:STAT ON

Query Syntax

[SOURce:]VOLTage:OVER:PROTection:STATe?

Return Parameters

0|1

[SOURce:]VOLTage:UNDer:PROTection[:LEVel] <NRf+>

This command sets the undervoltage protection limit for the power supply output.

Command Syntax

[SOURce:]VOLTage:UNDER:PROTection[:LEVel] <NRf+>

Parameter

<NRf+> MIN TO MAX
6962/6952:<0.000-60.600>
6963/6953:<0.000-150.150>

RST Value

0.00

Example

VOLT:UND:PROT 10.00

Query Syntax

[SOURce:]VOLTage:UNDER:PROTection[:LEVel]? [MINimum|MAXimum]

Return Parameters

NRf

[SOURce:]VOLTage:UNDER:PROTection:DElay <NRf+>

This command is used to set the delay time for undervoltage protection when the power supply is output.

Command Syntax

[SOURce:]VOLTage:UNDER:PROTection:DElay <NRf+>

Parameter

<0.00-10.00>

RST Value

10.00

Example

VOLT:UND:PROT:DEL 10.00

Query Syntax

[SOURce:]VOLTage:UNDER:PROTection:DElay? [MINimum|MAXimum]

Return Parameters

NRf

[SOURce:]VOLTage:UNDER:PROTection:STATe <BOOL>

This command is used to set the power supply undervoltage protection status.

Command Syntax

```
[SOURce:]VOLTage:UNDER:PROTection:STATe <BOOL>
```

Parameter

0|OFF|1|ON

RST Value

0

Example

```
VOLT:UND:PROT:STAT ON
```

Query Syntax

```
[SOURce:]VOLTage:UNDER:PROTection:STATe?
```

Return Parameters

0|1

[SOURce:]VOLTage:UNDER:PROTection:WARM <NRf+>

This command sets the warm-up time for power supply undervoltage protection.

Command Syntax

```
[SOURce:]VOLTage:UNDER:PROTection:WARM <NRf+>
```

Parameter

<0.00-30.00>

RST Value

30.00

Example

```
VOLT:UND:PROT:WARM 10.00
```

Query Syntax

```
[SOURce:]VOLTage:UNDER:PROTection:WARM? [MINimum|MAXimum]
```

Return Parameters

NRf

[SOURce:]VOLTage[:LEVel]:LIMit[:HIGH] <NRf+>

This command sets the maximum settable voltage of the power supply.

Command Syntax

[SOURce:]VOLTage[:LEVel]:LIMit[:HIGH] <NRf+>

Parameter

<MINimum-MAXimum|MINimum|MAXimum>

RST Value

MAXimum

Example

VOLT:LIM 60

Query Syntax

[SOURce:]VOLTage[:LEVel]:LIMit[:HIGH]? [MINimum|MAXimum]

Return Parameters

<NRf>

[SOURce:]VOLTage:DECimal?

The command returns the number of decimal places of the voltage value.

Command Syntax

[SOURce:]VOLTage:DECimal?

Parameter

None

Example

VOLT:DEC?

Return Parameters

<NR1>

[SOURce:]POWER[:LEVel]:LIMit[:HIGH] <NRf+>

This command sets the maximum power of the power supply.

Command Syntax

[SOURce:]POWER[:LEVel]:LIMit[:HIGH] <NRf+>

Parameter

<MINimum-MAXimum|MINimum|MAXimum>

RST Value

MAXimum

Example

POW:LIM 1500

Query Syntax

[SOURce:]POWer[:LEVel]:LIMit[:HIGH]? [MINimum|MAXimum]

Return Parameters

NRf

[SOURce:]POWer:PROTection[:LEVel] <NRf+>

This command sets the overpower protection limit of the power supply.

Command Syntax

[SOURce:]POWer:PROTection[:LEVel] <NRf+>

Parameter

<MINimum-MAXimum|MINimum|MAXimum>

RST Value

Power protection max.

Example

POW:PROT 1500.0

Query Syntax

[SOURce:]POWer:PROTection[:LEVel]? [MINimum|MAXimum]

Return Parameters

NRf

[SOURce:]POWer:PROTection:DELaY <NRf+>

This command is used to set the overpower protection delay time of the power supply.

Command Syntax

[SOURce:]POWer:PROTection:DELaY <NRf+>

Parameter

<0.00-10.00>

RST Value

10.00

Example

POW:PROT:DEL 10.00

Query Syntax

[SOURce:]POWer:PROTection:DELaY? [MINimum|MAXimum]

Return Parameters

NRf

[SOURce:]POWer:PROTection:STATe <BOOL>

This command sets the overpower protection state of the power supply.

Command Syntax

[SOURce:]POWer:PROTection:STATe <BOOL>

Parameter

0|OFF|1|ON

RST Value

0

Example

POW:PROT:STAT ON

Query Syntax

[SOURce:]POWer:PROTection:STATe?

Return Parameters

0|1

[SOURce:]POWer:DECimal?

This command returns the number of decimal places of the power value.

Command Syntax

[SOURce:]POWer:DECimal?

Parameter

None

Example

POW:DEC?

Return Parameters

<NR1>

[SOURce:]FUNCTION:MODE <FIXed|LIST>

This command sets the operating mode of the power supply.

Command Syntax

[SOURce:]FUNCTION:MODE < FIXed|LIST>

Parameter

< FIXed|LIST>

RST Value

FIXed

Example

FUNC:MODE LIST

Query Syntax

[SOURce:]FUNCTION:MODE?

Return Parameters

FIX|LIST

[SOURce:]FUNCTION:PRIority <VOLTage|CURRent>

This command is used to set the priority of the control loop of the power supply.

Command Syntax

[SOURce:]FUNCTION:PRIority <VOLTage|CURRent>

Parameter

<VOLTage|CURRent>

RST Value

VOLTage

Example

FUNC:PRI VOLT

Query Syntax

[SOURce:]FUNCTION:PRIority?

Return Parameters

VOLT|CURR

[SOURce:]APPLY <NRf+>,<NRf+>

This command sets the output voltage and current values. When the voltage is set to the maximum value, the maximum current cannot reach the maximum set current value of the machine due to the maximum power limitation.

Command Syntax

[SOURce:]APPLy <NRf+>,<NRf+>

Parameter

<NRf+> voltage value <MINimum-MAXimum|MINimum|MAXimum>

<NRf+> current value <MINimum-MAXimum|MINimum|MAXimum>

RST Value

0.00,Machine rated current value

Example

APPL 10.00,3.500

Query Syntax

[SOURce:]APPLy? [MINimum|MAXimum] [,MINimum|MAXimum]

Return Parameters

NRf,NRf

[SOURce:]EXTErn[:PROGrama][:STATE] <BOOL>

This command is used to set the external analog control function on or off (valid for external analog board).

Command Syntax

[SOURce:]EXTErn[:PROGrama][:STATE] <BOOL>

Parameter

0|OFF|1|ON

RST Value

Not applicable

Example

EXT 1

Query Syntax

[SOURce:]EXTErn[:PROGrama][:STATE]?

Return Parameters

0|1

[SOURce:]EXTErn[:PROGrama]:CHANnel:MX <NR1>,<NRf+>

This command sets the external analog mx value.

Command Syntax

[SOURce:]EXTErn[:PROGrama]:CHANnel:MX <NR1>,<NRf+>

Parameter

<0-1>,<Channel 0: (-10*voltage max.) - (10*voltage max.) Channel 1: (-10*current max.) - (10*current max.)>

RST Value

None

Example

EXT:CHAN:MX 0,1

Query Syntax

[SOURce:]EXTErn[:PROGrama]:CHANnel:MX? <NR1>

Example **EXT:CHAN:MX? 0**

Return Parameters

<NR1>,<NRf+>

[SOURce:]EXTErn[:PROGrama]:CHANnel:MB <NR1>,<NRf+>

This command sets the external analog mb value.

Command Syntax

[SOURce:]EXTErn[:PROGrama]:CHANnel:MB <NR1>,<NRf+>

Parameter

<0-1>,<Channel 0: (-voltage max.) -voltage max. Channel 1: (-current max.) -current max.>

RST Value

None

Example

EXT:CHAN:MB 0,0

Query Syntax

[SOURce:]EXTErn[:PROGrama]:CHANnel:MB? <NR1>

Example **EXT:CHAN:MB? 0**

Return Parameters

<NR1>,<NRf+>

[SOURce:]LEAK[:STATe] <BOOL>

This command sets the drain circuit on or off.

Command Syntax

[SOURce:]LEAK[:STATe] <BOOL>

Parameter

0|OFF|1|ON

RST Value

None

Example

LEAK ON

Query Syntax

[SOURce:]LEAK[:STATe]?

Return Parameters

0|1

[SOURce:]FUNction:SLEW:MODE <TIME|RATE>

This command sets the slope type of the power supply.

TIME: Time unit, seconds.

RATE: V/ms or A/ms.

Command Syntax

[SOURce:]FUNction:SLEW:MODE <TIME|RATE>

Parameter

<CPD>
<TIME|RATE>

RST Value

TIME

Example

FUNC:SLEW:MODE RATE

Query Syntax

[SOURce:]FUNction:SLEW:MODE?

Return Parameters

TIME|RATE

Chapter10 FETCh & MEASure Subsystem

MEASure[:SCALar]:CURRent[:DC]?

This command is used to return the actual current value of the power supply output.

Command Syntax

MEASure[:SCALar]:CURRent[:DC]?

Return Parameters

<NRf>

FETCh[:SCALar]:CURRent[:DC]?

This command is used to read the most recent preprocessor current reading from the sample buffer. After issuing this command and allowing the instrument to talk, the reading is sent to the computer.

This command does not trigger a measurement operation, but only requests the most recently available reading. The command returns the old reading until a new reading is available.

Command Syntax

FETCh[:SCALar]:CURRent[:DC]?

Return Parameters

<NRf>

MEASure[:SCALar]:VOLTage[:DC]?

This command is used to return the actual voltage value of the power supply output.

Command Syntax

MEASure[:SCALar]:VOLTage[:DC]?

Return Parameters

<NRf>

FETCh[:SCALar]:VOLTage[:DC]?

This command is used to read the most recent preprocessed voltage reading in the sample cache.

Command Syntax

FETCh[:SCALar]:VOLTage[:DC]?

Return Parameters

<NRf>

MEASure[:SCALar]:POWer[:DC]?

This command is used to return the actual power value output by the power supply.

Command Syntax

MEASure[:SCALar]:POWer[:DC]?

Return Parameters

<NRf>

FETCh[:SCALar]:POWer[:DC]?

This command is used to read the most recent preprocessed power reading in the sample cache.

Command Syntax

FETCh[:SCALar]:POWer[:DC]?

Return Parameters

<NRf>

MEASure:ALL?

This command is used to return the actual voltage, current, and power values of the power supply output.

Command Syntax

MEASure:ALL?

Parameter

None

RST Value

Not applicable

Example

MEAS:ALL?

Return Parameters

NRf, NRf, NRf

FETCh:ALL?

This command is used to read the most recent preprocessed voltage, current, and power readings from the sample cache.

Command Syntax

FETCh:ALL?

Parameter

None

RST Value

Not applicable

Example

FETC:ALL?

Return Parameters

NRf, NRf, NRf

FETCh:TIME?

This command queries the time when the output is turned on after the timer takes effect.

Command Syntax

FETCh:TIME?

Parameter

None

RST Value

Not applicable

Example

FETC:TIME?

Return Parameters

NRf

Chapter11 LIST Subsystem

LIST:STEP:COUNT <NR1>

Sets the number of steps in the LIST.

Command Syntax

LIST:STEP:COUNT <NR1>

Parameter

<1-100>

RST Value

Not applicable

Example

LIST:STEP:COUNT 1

Query Syntax

LIST:STEP:COUNT?

Return Parameters

NR1

LIST:STEP:VOLTage <NR1>,<NRf+>

Sets the number of steps in the LIST.

Command Syntax

LIST:STEP:VOLTage <NR1>,<NRf+>

Parameter

<1-100>,<MINimum-MAXimum|MINimum|MAXimum>

RST Value

Not applicable

Example

LIST:STEP:VOLT 1,2.00

Query Syntax

LIST:STEP:VOLTage? <NR1>[,MINimum|MAXimum]
Example **LIST:STEP:VOLT? 1**

Return Parameters

<NRf>

LIST:STEP:CURRent <NR1>,<NRf+>

Set the current in step N of the LIST.

First you need to send the command LIST:FUNC CURR to set to CC priority mode.

Command Syntax

LIST:STEP:CURRent <NR1>,<NRf+>

Parameter

<1-100>,<MINimum-MAXimum|MINimum|MAXimum>

RST Value

Not applicable

Example

LIST:STEP:CURR 1,3.500

Query Syntax

LIST:STEP:CURRent? <NR1>[,MINimum|MAXimum]

Example **LIST:STEP:CURR? 1**

Return Parameters

<NRf>

LIST:STEP:SLEW <NR1>,<NRf+>

Set the slope of the Nth step of the LIST.

Command Syntax

LIST:STEP:SLEW <NR1>,<NRf+>

Parameter

<1-100>,<MINimum-MAXimum|MINimum|MAXimum>

RST Value

Not applicable

Example

LIST:STEP:SLEW 1,1.000

Query Syntax

LIST:STEP:SLEW? <NR1>[,MINimum|MAXimum]

Example **LIST:STEP:SLEW? 1**

Return Parameters

NRf

LIST:STEP:WIDTH <NR1>,<NRf+>

Sets the width of the Nth step of the LIST.

Command Syntax

LIST:STEP:WIDTH <NR1>,<NRf+>

Parameter

<1-100>,<MINimum-MAXimum|MINimum|MAXimum>
Pulse width:<0.001-3600.000>

RST Value

Not applicable

Example

LIST:STEP:WIDT 1,1.000

Query Syntax

LIST:STEP:WIDTH? <NR1>[,MINimum|MAXimum]
Example LIST:STEP:WIDT? 1

Return Parameters

NRf

LIST:REPeat <NR1>

Sets the number of repetitions of the LIST.

Command Syntax

LIST:REPeat <NR1>

Parameter

<MINimum-MAXimum|MINimum|MAXimum>
<1-65535>

RST Value

Not applicable

Example

LIST:REP 3

Query Syntax

LIST:REPeat? [MINimum|MAXimum]

Return Parameters

NR1

LIST:FUNCTION <VOLTage|CURRent>

Sets the function mode of the LIST.

Command Syntax

LIST:FUNCTION <VOLTage|CURRent>

Parameter

<CPD>
VOLTage|CURRent

RST Value

Not applicable

Example

LIST:FUNC VOLT

Query Syntax

LIST:FUNCTION?

Return Parameters

VOLTage|CURRent

LIST:SAVE <NR1>

Save LIST to the nth memory cell.

Command Syntax

LIST:SAVE <NR1>

Parameter

<1-10>

RST Value

Not applicable

Example

LIST:SAVE 1

Query Syntax

None

LIST:RECall <NR1>

Callback the LIST stored in the Nth memory cell. execute the LIST:SAVE <NR1> command before calling.

Command Syntax

LIST:RECall <NR1>

Parameter

<1-10>

RST Value

Not applicable

Example

LIST:REC 1

Query Syntax

None

LIST[:STATe] <BOOL>

Turns the LIST function on or off.

Command Syntax

LIST[:STATe] <BOOL>

Parameter

<0|OFF|1|ON>

RST Value

Not applicable

Example

LIST ON

Query Syntax

LIST[:STATe]?

Return Parameters

0|1

LIST:TERMinate <NORMal|LAST|OFF>

Sets how the LIST ends.

Command Syntax

LIST:TERMinate <NORMal|LAST|OFF>

Parameter

<CPD>
<NORM|LAST|OFF>

RST Value

Not applicable

Example

LIST:TERM NORM

Query Syntax

LIST:TERMinate?

Return Parameters

NORM|LAST|OFF

LIST:PAUSE[:STATe] <BOOLEAN>

Sets the state of the LIST's PAUSE.

Command Syntax

LIST:PAUSE[:STATe] <BOOLEAN>

Parameter

<0|OFF|1|ON>

RST Value

Not applicable

Example

LIST:PAUS 1

Query Syntax

LIST:PAUSE[:STATe]?

Return Parameters

0|1

LIST:RUN:STEP?

Queries the current running step value of the LIST.

Command Syntax

LIST:RUN:STEP?

Parameter

None

RST Value

Not applicable

Example

LIST:RUN:STEP?

Return Parameters

NR1

LIST:RUN:REPeat?

Queries the number of repetitions of the current run of LIST.

Command Syntax

LIST:RUN:REPeat?

Parameter

None

RST Value

Not applicable

Example

LIST:RUN:REP?

Return Parameters

NR1

Chapter12 TRACe Subsystem

TRACe:CLEAr

This command is used to clear the read cache; if the cache is not cleared, subsequent stores will write over the old reads.

Command Syntax

TRACe:CLEAr

Parameter

None

RST Value

Not applicable

Example

TRAC:CLE

Query Syntax

None

Return Parameters

None

TRACe:POINts <NR1>

This command is used to set the size of the cache.

Command Syntax

TRACe:POINts <NR1>

Parameter

<2-1000>|MINimum|MAXimum

RST Value

1000

Example

TRAC:POIN MAX

Query Syntax

TRACe:POINts?

Return Parameters

NR1

TRACe:FEED:CONTRol <NEVer|NEXT|ALWays>

This command is used to select cache control. Select NEVer to disable caching; NEXT to start the procedure, fill the cache, and then stop it; and ALWays to fill the cache and then it will cycle through the storage.

Command Syntax

```
TRACe:FEED:CONTRol <NEVer|NEXT|ALWays>
```

Parameter

```
<CPD> NEVer|NEXT|ALWays
```

RST Value

```
NEVer
```

Example

```
TRAC:FEED:CONT NEXT
```

Query Syntax

```
TRACe:FEED:CONTRol?
```

Return Parameters

```
NEVer|NEXT|ALWays
```

TRACe:FEED[:SELeCted] <VOLTage|CURRent|BOTH>

This command is used to select the source of readings to be placed into the cache, by selecting VOLTage, voltage readings are placed into the cache, by selecting CURRent, current readings are placed into the cache, and if both VOLTage and CURRent are selected, both voltage and current are placed into the cache when the store action is executed.

Command Syntax

```
TRACe:FEED[:SELeCted] <VOLTage|CURRent|BOTH>
```

Parameter

```
<CPD> VOLTage|CURRent|BOTH
```

RST Value

```
BOTH
```

Example

```
TRAC:FEED BOTH
```

Query Syntax

```
TRACe:FEED?
```

Return Parameters

```
VOLTage|CURRent|BOTH
```

TRACe:DELaY

This command is used to select the cache trigger delay time.

Command Syntax

TRACe:DELaY

Parameter

0.001S to 3600s|MINimum|MAXimum

RST Value

0.001S

Example

TRAC:DEL MINimum

Query Syntax

TRACe:DELaY?

Return Parameters

NR2

TRACe:TIMer

This command is used to select the cache interval.

Command Syntax

TRACe:TIMer

Parameter

<0.001-3600.0>
MINimum-MAXimum|MINimum|MAXimum

RST Value

0.001S

Example

TRAC:TIM

Query Syntax

TRACe:TIMer?

Return Parameters

NR2

TRACe:POINTs:ACTual?

This command is used to read the number of real readings in the cache.

Command Syntax

TRACe:POINts:ACTual?

Parameter

None

RST Value

0

Example

TRAC:POIN:ACT?

Return Parameters

NR1

TRACe:DATA?

This command is used to read the value in the cache.

NOTE

Before sending this command, you need to execute the TRIGger[:IMMediate] instruction to trigger the instrument to enter the data storage state, and you need to make sure that the Parameter of the TRACe:FEED:CONTRol <NEXT|ALWays|NEVer> instruction is set to NEXT or ALWays, or else the system will report an error if you send the TRACe:DATA? command will result in an error.

Command Syntax

TRACe:DATA?

Parameter

None

RST Value

Not applicable

Example

TRACe:DATA?

Return Parameters

<NR3>,<NR3>,<NR3>,<NR3>...,<NR3> Returns multiple NR3 type data

TRACe:FILTer <BOOL>

This command is used to set whether to turn on the filter.

Command Syntax

TRACe:FILTer <BOOL>

Parameter

<0|OFF|1|ON>

RST Value

1

Example

TRAC:FILT 1

Query Syntax

TRACe:FILTer?

Return Parameters

0|1

Chapter13 IEEE-488 Command

***CLS**

This order can clean the register as follows:

- Standard event status register
- Query event register
- Status byte register

Command Syntax

***CLS**

Parameter

None

***ESE <NR1>**

This order can set the parameter of standard event enable register. Setting parameter can determine which bit value of standard event register is 1 and the byte will enable ESB of status byte register is 1.

Command Syntax

***ESE <NR1>**

Parameter

0~255

PowerOn Value

Refer to the *PSC command

Example

***ESE 128**

Query Syntax

***ESE?**

Return Parameters

<NR1>

Related Command

***ESR? *PSC *STB?**

***IDN?**

This order can read information about power supply. The parameter it returns contains 4 segments divided by comma.

Query Syntax

*IDN?

Parameter

None

Return Parameters

<SRD>

Example

ITECH Ltd.,IT-N6900,60234567890123456,1.01-1.02-1.03

***OPC**

When all orders before this order are executed, OPC is 1 for the standard event status register. Sending query order will return 1 to output buffer.

Command Syntax

*OPC

Parameter

None

Query Syntax

*OPC?

Return Parameters

<NR1>

***PSC <BOOL>**

This order control if power supply send a request or not when it is re-powered.

Parameter

0|OFF|1|ON

Example

*PSC 0

Query Syntax

*PSC?

Return Parameters

0|1

Related Command

*ESE *SRE STAT:OPER:ENAB STAT:QUES:ENAB

***RST**

This order reset the power supply to default setting.

Command Syntax

*RST

Parameter

None

***SRE <NR1>**

This order can set the parameter of standard event register. When query status bit enable register, the power will return a decimal number, this number is the binary weighted of enable register.

Command Syntax

*SRE <NR1>

Parameter

0~255

PowerOn Value

Refer to the *PSC command

Example

*SRE 128

Query Syntax

*SRE?

Return Parameters

<NR1>

Related Command

*ESE *ESR? *PSC *STB?

***STB?**

This order can read the data from status byte register. This order is similar to a statistics of series, but the equivalent of another instrument orders, it returns the value the same as series statistics, but after this order is executed, the bit 6 value of status byte register is cleared, while the status bit will not be cleared when system statistics implemented.

Query Syntax

*STB?

Parameter

None

Return Parameters

<NR1>

Related Command

*CLS *ESE *ESR

*TRG

When the trigger mode of the power supply is BUS order trigger mode, the order will generate a trigger signal. The function is the same as **TRIGger[:IMMediate]**.

Command Syntax

*TRG

Parameter

None

Related Command

TRIG TRIG:SOUR

*SAV <NR1>

This command will save the present setting value of the power supply to the specified storage area.

Command Syntax

*SAV <NR1>

Parameter

1~60

Example

*SAV 3

Related Command

*RCL

*RCL <NR1>

This command will recall the setting value of the power supply from the specified storage area.

Command Syntax

*RCL <NR1>

Parameter

1~60

Example

*RCL 3

Related Command

*SAV

***TST?**

This command can be used to query the self-test status of the instrument. If the query result is 0, it means the instrument self-test is successful, other parameters mean the self-test is failed, and an error message will be generated to explain the reason of failure.

Query Syntax

*TST?

Parameter

None

Return Parameters

<NR1>,<str>

Contact Us

Thanks for purchasing ITECH products. In case of any doubts, please contact us as follows:

1. Visit ITECH website:www.itechate.com
2. Select the most convenient contact method, for further information.