

Programmable AC Power Supply

IT7800HV Series User Manual



Model: IT7800HV

Version: V1.0/2024.10

Notices

© Itech Electronic, Co., Ltd. 2024
No part of this manual may be reproduced in any form or by any means (including electronic storage and retrieval or translation into a foreign language) without prior permission and written consent from Itech Electronic, Co., Ltd. as governed by international copyright laws.

Manual Part Number

IT7800HV

Revision

1st Edition: Nov. 8, 2024
Itech Electronic, Co., Ltd.

Trademarks

Pentium is U.S. registered trademarks of Intel Corporation.

Microsoft, Visual Studio, Windows and MS Windows are registered trademarks of Microsoft Corporation in the United States and/or other countries and regions.

Warranty

The materials contained in this document are provided “as is”, and is subject to change, without prior notice, in future editions. Further, to the maximum extent permitted by applicable laws, ITECH disclaims all warranties, either express or implied, with regard to this manual and any information contained herein, including but not limited to the implied warranties of merchantability and fitness for a particular purpose. ITECH shall not be held liable for errors or for incidental or indirect damages in connection with the furnishing, use or application of this document or of any information contained herein. Should ITECH and the user enter into a separate written agreement with warranty terms covering the materials in this document that conflict with these terms, the warranty terms in the separate agreement shall prevail.

Technology Licenses

The hardware and/or software described herein are furnished under a license and may be used or copied only in accordance with the terms of such license.

Restricted Rights Legend

Restricted permissions of the U.S. government. Permissions for software and technical data which are authorized to the U.S. Government only include those for custom provision to end users. ITECH provides this customary commercial license in software and technical data pursuant to FAR 12.211 (Technical Data) and 12.212 (Computer Software) and DFARS 252.227-7015 (Technical Data – Commercial Items) and DFARS 227.7202-3 (Rights in Commercial Computer Software or Computer Software Documentation).

Safety Notices

CAUTION

A CAUTION sign denotes a hazard. It calls attention to an operating procedure or practice that, if not correctly performed or adhered to, could result in damage to the product or loss of important data. Do not proceed beyond a CAUTION sign until the indicated conditions are fully understood and met.

WARNING

A WARNING sign denotes a hazard. It calls attention to an operating procedure or practice that, if not correctly performed or adhered to, could result in personal injury or death. Do not proceed beyond a WARNING sign until the indicated conditions are fully understood and met.



NOTE

A NOTE sign denotes important hint. It calls attention to tips or supplementary information that is essential for users to refer to.

Quality Certification and Assurance

We certify that IT7800HV series power supply meets all the published specifications at time of shipment from the factory.

Warranty

ITECH warrants that the product will be free from defects in material and workmanship under normal use for a period of one (1) year from the date of delivery (except those described in the Limitation of Warranty below).



NOTE

Visit <https://www.itechate.com/en/support/register.html> to complete product registration by filling out the necessary information to extend the warranty to two (2) years.

For warranty service or repair, the product must be returned to a service center designated by ITECH.











- The product returned to ITECH for warranty service must be shipped PREPAID. And ITECH will pay for return of the product to customer.
- If the product is returned to ITECH for warranty service from overseas, all the freights, duties and other taxes shall be on the account of customer.



Limitation of Warranty

This Warranty will be rendered invalid if the product is:

- Damaged resulting from customer-wired circuits or customer-supplied parts or accessories;
- Modified or repaired by customer without authorization;
- Damaged resulting from customer-wired circuits or use in an environment not designated by us;
- The product model or serial number is altered, deleted, removed or made illegible by customer;
- Damaged as a result of accidents, including but not limited to lightning, moisture, fire, improper use or negligence.

Safety Symbols

	Direct current		ON (power)
	Alternating current		OFF (power)
	Both direct and alternating current		Power-on state
	Chassis (earth ground) symbol.		Power-off state
	Earth (ground) terminal		Reference terminal

	Caution	+	Positive terminal
	Warning (refer to this manual for specific Warning or Caution information)	-	Negative terminal
	A chassis terminal	-	-

Safety Precautions

The following safety precautions must be observed during all phases of operation of this instrument. Failure to comply with these precautions or specific warnings elsewhere in this manual will constitute a default under safety standards of design, manufacture and intended use of the instrument. ITECH assumes no liability for the customer's failure to comply with these precautions.

WARNING

- Do not use the instrument if it is damaged. Before operation, check the casing to see whether it cracks. Do not operate the instrument in the presence of inflammable gasses, vapors or dusts.
- The instrument is provided with a power cord during delivery and should be connected to a socket with a protective earth terminal, a junction box or a three-phase distribution box. Before operation, be sure that the instrument is well grounded.
- Check all marks on the instrument before connecting the instrument to power supply.
- Use electric wires of appropriate load. All loading wires should be capable of bearing maximum short-circuit of electronic load without overheating. If there are multiple loads, each pair of the load power cord must be carry out the full rated short-circuit output current of the power securely.
- Ensure the voltage fluctuation of mains supply is less than 10% of the working voltage range in order to reduce risks of fire and electric shock.
- Do not install alternative parts on the instrument or perform any unauthorized modification.
- Do not use the instrument if the detachable cover is removed or loosen.
- To prevent the possibility of accidental injuries, be sure to use the power adapter supplied by the manufacturer only.
- We do not accept responsibility for any direct or indirect financial damage or loss of profit that might occur when using the instrument.
- This instrument is used for industrial purposes, do not apply this product to IT power supply system.
- Never use the instrument with a life-support system or any other equipment subject to safety requirements.

WARNING

- **SHOCK HAZARD Ground the Instrument.** This product is provided with a protective earth terminal. To minimize shock hazard, the instrument must be connected to the AC mains through a grounded power cable, with the ground wire firmly connected to an electrical ground (safety ground) at the power outlet or distribution box. Any interruption of the protective (grounding) conductor or disconnection of the protective earth terminal will cause a potential shock hazard that could result in injury or death.
- Before applying power, verify that all safety precautions are taken. All connections must be made with the instrument turned off, and must be performed by qualified personnel who are aware of the hazards involved. Improper actions can cause fatal injury as well as equipment damage.
- **SHOCK HAZARD, LETHAL VOLTAGES** This product can input the dangerous voltage that can cause personal injury, and the operator must always be protected from electric shock. Ensure that the input electrodes are either insulated or covered using the safety covers provided, so that no accidental contact with lethal voltages can occur.
- Never touch cables or connections immediately after turning off the instrument. Verify that there is no dangerous voltage on the electrodes or sense terminals before touching them.

CAUTION

- **Failure to use the instrument as directed by the manufacturer may render its protective features void.**
- **Always clean the casing with a dry cloth. Do not clean the internals.**
- **Make sure the vent hole is always unblocked.**

Environmental Conditions

The instrument is designed for indoor use and an area with low condensation. The table below shows the general environmental requirements for the instrument.

Environmental Conditions	Requirements
Operating temperature	0°C~50°C
Operating humidity	20%~80%(non-condensation)
Storage temperature	-10°C~70 °C
Altitude	Operating up to 2,000 meters
Installation category	II
Pollution degree	Pollution degree 2



Note

To make accurate measurements, allow the instrument to warm up for 30 min.

Regulatory Markings



The CE mark indicates that the product complies with all the relevant European legal directives. The specific year (if any) affixed refers to the year when the design was approved.

	<p>The instrument complies with the WEEE Directive (2002/96/EC) marking requirement. This affix product label indicates that you must not discard the electrical/electronic product in domestic household waste.</p>
	<p>This symbol indicates the time period during which no hazardous or toxic substances are expected to leak or deteriorate during normal use. The expected useful life of the product is 10 years. The product can be used safely during the 10-year Environment Friendly Use Period (EFUP). Upon expiration of the EFUP, the product must be immediately recycled.</p>

Waste Electrical and Electronic Equipment (WEEE) Directive



2002/96/EC Waste Electrical and Electronic Equipment (WEEE) Directive

This product complies with the WEEE Directive (2002/96/EC) marking requirement. This affix product label indicates that you must not discard the electrical/electronic product in domestic household waste.

Product Category

With reference to the equipment classifications described in the Annex 1 of the WEEE Directive, this instrument is classified as a "Monitoring and Control Instrument".

To return this unwanted instrument, contact your nearest ITECH office.

Compliance Information

Complies with the essential requirements of the following applicable European Directives, and carries the CE marking accordingly:

- Electromagnetic Compatibility (EMC) Directive 2014/30/EU
- Low-Voltage Directive (Safety) 2014/35/EU

Conforms with the following product standards:

EMC Standard

IEC 61326-1:2012/ EN 61326-1:2013 ¹²³

Reference Standards

CISPR 11:2009+A1:2010/ EN 55011:2009+A1:2010 (Group 1, Class A)

IEC 61000-4-2:2008/ EN 61000-4-2:2009

IEC 61000-4-3:2006+A1:2007+A2:2010/ EN 61000-4-3:2006+A1:2008+A2:2010

IEC 61000-4-4:2004+A1:2010/ EN 61000-4-4:2004+A1:2010

IEC 61000-4-5:2005/ EN 61000-4-5:2006

IEC 61000-4-6:2008/ EN 61000-4-6:2009

IEC 61000-4-11:2004/ EN 61000-4-11:2004

1. The product is intended for use in non-residential/non-domestic environments. Use of the product in residential/domestic environments may cause electromagnetic interference.
2. Connection of the instrument to a test object may produce radiations beyond the specified limit.
3. Use high-performance shielded interface cable to ensure conformity with the EMC standards listed above.

Safety Standard

IEC 61010-1:2010/ EN 61010-1:2010

Content

Quality Certification and Assurance	i
Warranty	i
Limitation of Warranty	i
Safety Symbols	i
Safety Precautions.....	ii
Environmental Conditions.....	iii
Regulatory Markings	iii
Waste Electrical and Electronic Equipment (WEEE) Directive	iv
Compliance Information	v
Chapter1 Quick Reference	8
1.1 Brief Introduction	8
1.2 Front Panel Introduction	9
1.3 Keyboard Introduction	10
1.4 Push-on Knob	11
1.5 Rear Panel Introduction	12
1.6 Home-Screen Overview	13
1.7 Optional accessories	15
Chapter2 Inspection and Installation	17
2.1 Unpacking and Transportation	17
2.2 Verifying the Shipment.....	18
2.3 Instrument Size Introduction	19
2.4 Connecting the Power Cord	20
2.5 Connecting Test Lines (Optional).....	22
Chapter3 Getting Started	25
3.1 Power-on the Instrument.....	25
3.2 Touch Screen Introduction	26
3.3 Set output parameters	26
3.4 Output On/Off Control.....	27
Chapter4 Operation and Application	28
4.1 Select the Output Mode.....	28
4.1.1 AC Output Mode	28
4.1.2 AC+DC Mode	28
4.2 Waveform Selection	29
4.3 Auto-range Function	30
4.4 Current Limit Mode and Power Limit Mode	30
4.5 Sweep Function	31
4.6 Power Amplifier	32
4.7 Programmable Output Impedance	32
Chapter5 System-Related Functions	33
5.1 System Menu Reference	33
5.1.1 Menu function.....	38
5.1.2 Set the communication interface	39
5.1.3 View the System Information	40
5.2 Configuration Menu Reference	40
5.3 Key Lock Function.....	42
5.4 Switching Local/Remote Mode	42
5.5 Save and Recall Operations	42
5.6 Protection Function.....	43
5.6.1 Current RMS Protection	44
5.6.2 Set the Current Peak protection	44
5.6.3 Set Voltage/Current/Power Limit Range	45
5.6.4 Over-temperature protection (OTP).....	45

5.6.5 Over-power protection (OPP).....	45
5.7 Screen Capture Function.....	46
5.8 Trigger Function.....	46
5.9 Query the System Log.....	46
5.10 Query the Energy.....	46
5.11 Remote Measurement Function.....	46
5.12 Digital I/O Function.....	47
5.13 Analogue Function (Ext-Program) (Optional).....	50
Chapter6 Measurement Functions.....	54
6.1 Meter Mode.....	54
6.2 Oscilloscope Mode.....	55
6.3 Harmonic measurement.....	57
6.3.1 Harmonic measurement.....	57
6.3.2 Harmonic Analysis (Coming soon).....	59
6.4 Recorder Function.....	61
Chapter7 Configuration Arbitrary Waveform.....	63
7.1 List Function.....	63
7.1.1 Create a new List file.....	63
7.1.2 Open/Run List File.....	65
7.1.3 Import/Export List file.....	66
7.2 Setting of Surge/Sag Configuration (Coming soon).....	67
7.3 Self-defined Waveform Function.....	68
7.3.1 THD.....	68
7.3.2 User-defined waveform.....	71
Chapter8 Technical Specifications.....	73
8.1 Supplemental characteristics.....	73
8.2 Main technical parameters.....	73
IT7890-700-90.....	73
IT78180-700-180.....	74
IT78135-1050-90.....	75
IT78270-1050-180.....	77
Chapter9 Remote Control.....	79
9.1 USB Interface.....	79
9.2 LAN Interface.....	79
9.3 CAN Interface.....	82
9.4 GPIB Interface (Optional).....	83
9.5 RS-232 Interface (Optional).....	84
9.6 Commonly Used Commands Overview.....	85
9.7 Demo Software Introduction.....	86
Appendix.....	87
Specifications of Red and Black Test Lines.....	87

Chapter1 Quick Reference

This chapter introduces the front panel, the rear panel, key functions and LCD display function of the IT7800HV series power supply, make sure that you can quickly know the appearance, instruction and the key function before you operate the power supply. Help you make better use of this series of power supply.

1.1 Brief Introduction

The IT7800HV series is a new generation of high power programmable AC power supply featuring user-friendly programming options, a novel touch interface, and rich waveform analysis capabilities. The high-voltage series is available at voltages as high as 700 VL-N and even fulfills 1050 VL-N test standards. By paralleling them, the high voltage series may be easily enlarged to 900 kVA.

The IT7800HV series is equipped with an LCD touch screen design with an intuitive and easy-to-use UI interface allowing users to quickly and smoothly use the operation. Built-in all-round power meter and arbitrary waveform generator, which can simulate harmonics and various arbitrary waveform outputs; programmable output impedance and a full range of measurement functions make the IT7800HV series widely used in new energy, power electronics, scientific research institutions and other fields of research and development, production, quality control and other stages.

Features

- Voltages up to 700 VL-N, even 1050 VL-N
- Harmonic simulation and analysis functions up to 50th ^{*1}
- Output frequency: 16-100Hz, voltage and frequency output variation rate adjustable
- Built-in AC power meter
- AC/AC+DC output mode possible
- Three-phase output
- Programmable output impedance
- Touch screen design, simple UI interface
- Arbitrary waveform output can be simulated, and CSV file import waveform is supported.
- Built-in rich waveform database
- List mode analog utility reproduction function, realizing the instantaneous power interruption simulation function
- Output start/stop phase angle can be set from 0 to 360°.
- Surge & Sag function ^{*2}
- Relay Ctrl relay control output function for electrical isolation between the object to be measured and the source.
- Built-in USB/CAN/LAN/digital IO interface, optional GPIB/RS232 interface.

^{*1} Voltage and current harmonic analysis, Voltage harmonic simulation

^{*2} Coming soon

IT7800 700V Model Reference

Model	VL-N	VL-L	Current	Power	Phase	Height
IT7890-700-90	700V L-N	1200V L-L	90Arms(3Φ)	90kVA	3Φ	27U
IT78180-700-180	700V L-N	1200V L-L	180Arms(3Φ)	180kVA	3Φ	27U*2
IT78270-700-270	700V L-N	1200V L-L	270Arms(3Φ)	270kVA	3Φ	27U*3
IT78360-700-360	700V L-N	1200V L-L	360Arms(3Φ)	360kVA	3Φ	27U*4
IT78450-700-450	700V L-N	1200V L-L	450Arms(3Φ)	450kVA	3Φ	27U*5
IT78540-700-540	700V L-N	1200V L-L	540Arms(3Φ)	540kVA	3Φ	27U*6
IT78630-700-630	700V L-N	1200V L-L	630Arms(3Φ)	630kVA	3Φ	27U*7
IT78720-700-720	700V L-N	1200V L-L	720Arms(3Φ)	720kVA	3Φ	27U*8
IT78810-700-810	700V L-N	1200V L-L	810Arms(3Φ)	810kVA	3Φ	27U*9
IT78900-700-900	700V L-N	1200V L-L	900Arms(3Φ)	900kVA	3Φ	27U*10

IT7800 1050V Model Reference

Model	VL-N	VL-L	Current	Power	Phase	Height
IT78135-1050-90	1050V L-N	1818V L-L	90Arms(3Φ)	135kVA	3Φ	37U
IT78270-1050-180	1050V L-N	1818V L-L	180Arms(3Φ)	270kVA	3Φ	37U*2
IT78405-1050-270	1050V L-N	1818V L-L	270Arms(3Φ)	405kVA	3Φ	37U*3
IT78540-1050-360	1050V L-N	1818V L-L	360Arms(3Φ)	540kVA	3Φ	37U*4
IT78675-1050-450	1050V L-N	1818V L-L	450Arms(3Φ)	675kVA	3Φ	37U*5
IT78810-1050-540	1050V L-N	1818V L-L	540Arms(3Φ)	810kVA	3Φ	37U*6

Naming rules for this series of model are as follows: IT78XXX-YYY-ZZZ, wherein, XXX means rated power, YYY means rated voltage, and ZZZ means rated current. Take IT7890-700-90 for an example, the rated power is 90kVA, rated voltage is 700V and rated current is 90A.

1.2 Front Panel Introduction

The front panel of the master model is shown below.

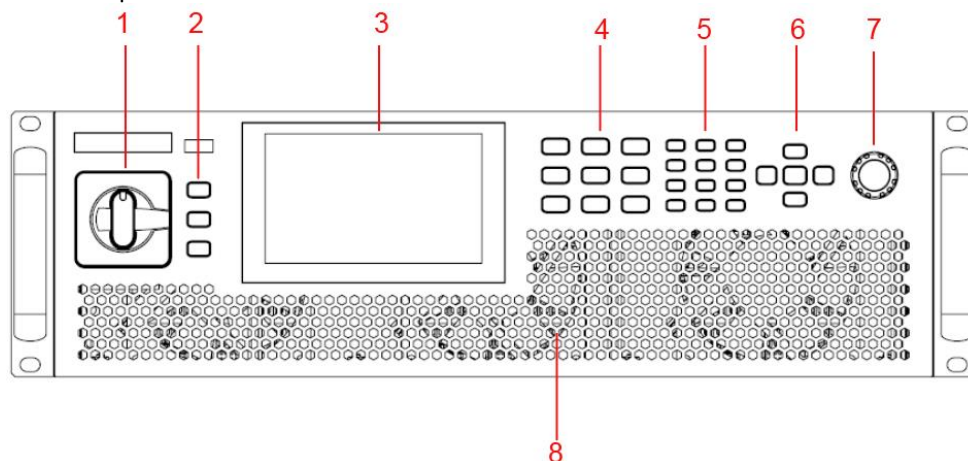

1 Power Switch
3 LCD touch screen

2 USB interface /Print/Trig/Menu
4 Function key



5 Number key
7 Rotary knob

6 Up, down, left and right key and enter key
8 Vent hole

1.3 Keyboard Introduction



The keyboard introduction of IT7800HV series Power Supply is shown as follows.



Keys	Description
Print	Used for saving screen images
Trig	Used for manual trigger
Power	Power Switch
Menu	Used for going back to menu page
[V-set]	Set the output voltage value
[F-set]	<ul style="list-style-type: none"> AC mode: set the output frequency DC mode: [F-set] is invalid
Config	Enter to Configuration menu
	Basic meter key used for basic metering.
	Waveform Display key When this key is pressed, the waveform corresponding to current measurement data will be displayed.
	Harmonic Measurement key When this key is pressed, the harmonic measurement results and the menu of harmonic measurement parameter configuration will be displayed.
[On/Off]	Turn the power supply output on or off. When lit, indicates that the output is enabled or on.
Shift	Composite key, combined with other keys to realize functions marked above keys.
Esc	Press this key to exit the current operation interface.
[0]-[9]	Number key. Enter the number directly
+/-	Positive and negative signs
.	Decimal point
Left / Right Navigation keys	The left and right navigation keys are used to adjust the cursor to the specified position or scrolls pages to view menu items.
Up / Down Navigation keys	The up and down navigation keys are used to scroll page up and down to view menu items.

Keys	Description
Enter	Operation confirmation key.

Composite key **[Shift]**, combined with other keys to realize functions marked above keys. In this manual, composite key is displayed as **[Shift]+[Esc]**. Firstly, press **[shift]** and the shift key will be lighted, and then press the function key, the detailed functions are listed as follows.

Keys	Description
[Shift]+[V-set](List)	Enter the List function menu.
[Shift]+[F-set] (Sweep)	Enter the Sweep function menu.
[Shift]+[Config](Protect)	Enter the protection setting menu.
[Shift]+  (System)	Enter the System setting menu. Used to set the system parameters.
[Shift]+  (Surge&Sag)	Enter the Surge and Sag menu, used to Set the Surge/trapped Configuration.
[Shift]+  (Standard)	Enter the standard regulation wave selection interface.
[Shift]+[1](Log)	Enter the data logging function menu.
[Shift]+ [2] (Lock)	Turn the keyboard lock on or off.
[Shift]+[3] (Local)	Switch remote control mode to local control mode.
[Shift]+[4] (Save)	Save the common parameter settings.
[Shift]+ [5] (Recall)	Enter the Protect menu of the power supply.
[Shift]+ [6] (Hold)	When you need to keep the present meter status, you can press the keys. Then the present meter status display and will be kept no matter whether output is running.
[Shift]+ [7] (Help)	Obtain the help information.

1.4 Push-on Knob

The IT7800HV series Power Supply provides a knob on the front panel as shown in the next figure.



The functions of the push-on knob is described as follows.

- Adjust the value setting
- Select menu item
- Confirm the set value or the selected menu item

Adjust the Value Setting

In the value setting interface, rotate the knob clockwise to increase the set value and anticlockwise to decrease the set value.

Select Menu Item

The knob can also be used to view menu items. In the menu item display interface, turning the knob clockwise indicates that the next menu item is selected, and turning the knob anticlockwise indicates that the previous menu item is selected.

Confirm settings

After completing the value setting or selecting a menu item, pushing the knob acts like pressing **[Enter]** key to confirm the operation.

1.5 Rear Panel Introduction

The 700V and 1050V models only differ in height, the rear panels are the same, and the following describes the information of the panels except for the vent hole.

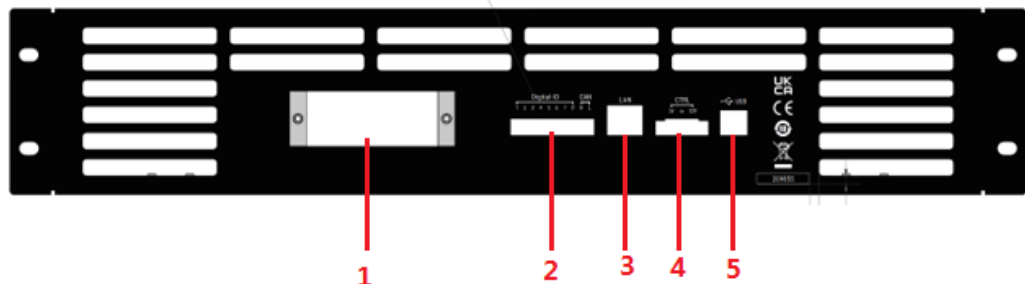

No.	Name	Description
1	Optional expansion slot	Optional interfaces: (Plastic plugs are inserted by default when the user does not purchase the interface.) The optional interface as follows: <ul style="list-style-type: none"> ● GPIB ● RS-232/ Analog interface
2	I/O terminals/CAN interface	Digital Port CAN communication interface CAN-H and CAN-L
3	LAN interface	LAN communication interface
4	External control interface CTRL	This interface is used for the parallel connection between the master (with operation panel) and the slaves (without operation panel). Connect the interface on the rear panel of each unit to be connected in parallel, and the master can offer synchronous control over the power-on/off of the slaves.
5	USB interface	USB communication interface.

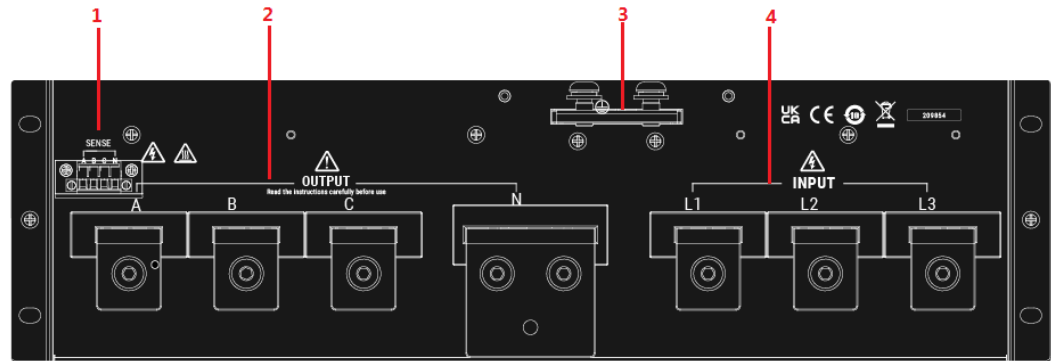

No.	Name	Description
1	Remote sense Terminals	SL+ and SN- are remote sense terminals, used for maximizing measurement accuracy.
2	Output terminals	AC or DC output terminals and chassis ground terminals, used to connect DUT.
3	ground terminal	Terminals for making chassis ground Connection and AC input ground connection.
4	AC power input Socket(M4)	Used to connect AC power to start instrument.

1.6 Home-Screen Overview

This series power supply adopts touch screen design, users can select and switch directly by pressing or dragging on the screen.

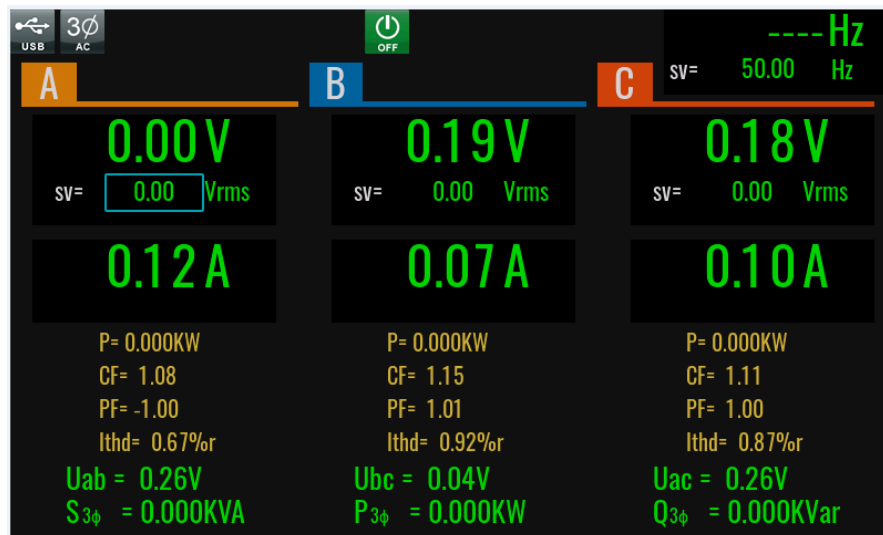





























Under three-phase mode, display total parameters corresponding to Phase A, B and C, the user can switch screen and view the total parameters of each phase. When you press the basic meter button or drag the screen left, you can switch from the three-phase display interface to the single-phase display interface. By default, phase A is displayed in the single-phase display interface. Click A, B and C to switch.













The meter interface of phase A is shown as follow, the display parameters are the same as single mode except for the phase indicator.



Introduction to Interface Symbols

The interface of IT7800HV power supply will display the following symbols. All the symbols and description are listed in the table below.

Icon	Function description	Icon	Function description
	Compound key		Output is off
	Output is on		Key operation is locked
	Three phase AC+DC mode		Three phase AC mode
	The AC source is in remote mode		Surge&Sag function indicator
	Fast speed		Low speed
	Medium speed		SYNC unlock
	Current limit		Sink power
	External Simulation Test Function		Record log
	LIST is running		LIST is finished
	LIST function is waiting for trigger		Sweep function is waiting for trigger
	Sweep running indicator		Found USB disk
	Sense indicator		Sense Error
	Unbalanced current		Output inhibit
	Input oscillation protection		Peak OVP

Icon	Function description	Icon	Function description
 OV	Over voltage protection	 OTP	Over temperature protection
 PEAK	AC/AC+DC mode Peak OCP	 RMS	AC/AC+DC mode RMS OCP
 POWER	Over power protection	 FIBERS	Fiber is error
 WDG	Watch dog	 ERROR	Command error
	Cue image collapse, click to expand all icons	 SYNC	SYNC lock
 INTERHARMONICS	inter-harmonics simulation	 UTP	UTP protection

Menu Interface

Press **[Menu]** key and enter to the menu interface. The screen contains ICONS for all function options. You can select them by using arrow keys or knob, or directly touch the ICONS to enter the corresponding function setting page.

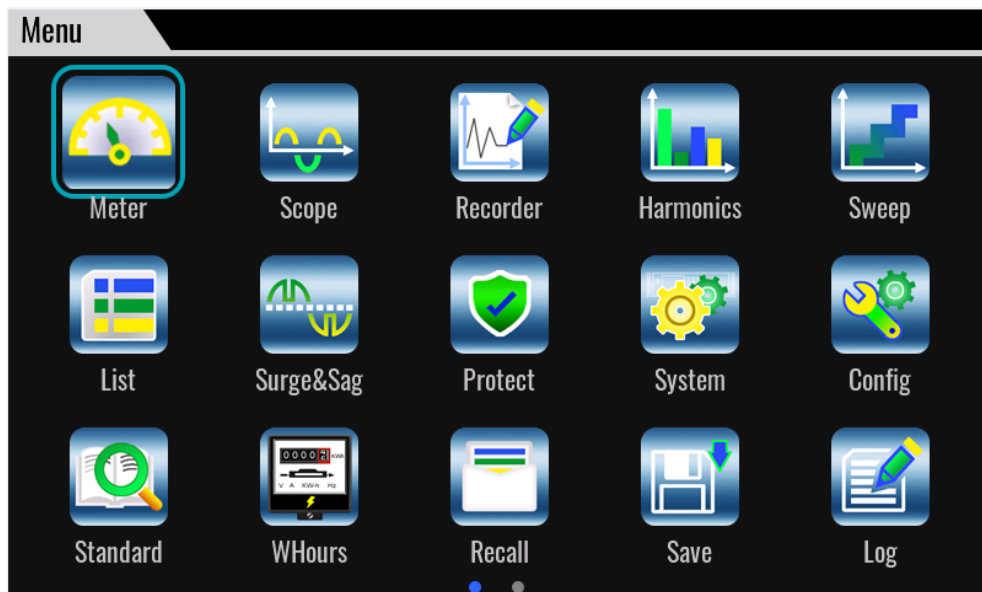

1.7 Optional accessories

The IT7800HV series supports the following optional accessories (sold separately), the details are shown as below:

The interface expansion slot provided on the rear panel of the IT7800HV series instrument allows users to flexibly expand according to their needs. Different interface cards can be selected to achieve different functions.

The following optional accessories from ITECH are sold separately. Users need to purchase separately.

Device Name	Model	Description
GPIB communication interface	IT-E176	When the user needs to use GPIB interface to enable remote operation, this option is the right choice.
RS232+Analog	IT-E177	Interface card that includes RS-232 communication interface and external analog. When the user needs to use RS-232 or external analog interface to enable remote operation, this option is the right choice.
Fiber modules and optic cables	IT-E168	<p>Used for parallel connection between the units in a cabinet, including one fiber module and two fiber cables, with lengths of 1.5 meters and 0.3 meters.</p> <p>The fiber optic module and cable are the necessary accessories for the parallel connection. Different numbers of fiber optic modules and cables are used in different numbers of parallels.</p>
Fiber modules and optic cables	IT-E169	<p>Used for parallel connection between cabinets, including one fiber module and one 2.5m fiber cable.</p> <p>The fiber optic module and cable are the necessary accessories for the parallel connection. Different numbers of fiber optic modules and cables are used in different numbers of parallels.</p>

Chapter2 Inspection and Installation

2.1 Unpacking and Transportation

Unpacking

For cabinet products, they are packaged in wooden boxes at the factory. After you receive them, please refer to the unpacking instructions provided with the box for disassembly; for products packaged in cartons, please use appropriate tools for unpacking.

It is recommended to keep the complete transport packaging for the lifetime of the device for relocation or return to the manufacture for repair.

Transportation

If you need to transport non-cabinet products, you must pay attention to the following to ensure the safety of equipment and personnel.

CAUTION

- Before moving, make sure that the cabinet or stand where the equipment will be placed has been fixed and meets the load-bearing conditions to avoid tilting and collapsing, causing personnel to be injured, and equipment broken.
- Due to the weight of the product, transport by hand should be avoided where possible. If unavoidable, carry it with two people and holding the product shell and not external parts (such as handles, electrodes, knobs, etc.).
- When carrying, be prepared to bear the weight to avoid sprains or being crushed by heavy objects.
- Use suitable safety clothing, especially safety shoes, when carrying the equipment, as due to its weight a fall can have serious consequences.

After unpacking the cabinet product, if you need to move it to other places, you must pay attention to the following matters to ensure the safety of equipment and personnel.

CAUTION

- The cabinet product is very heavy. Before moving to another location, confirm whether the ground load is in compliance.
- During the process of moving the cabinet, it is recommended that two or more people cooperate and push it slowly and at a constant speed. If you encounter a pit, you need to pay special attention. It is forbidden to push it quickly, otherwise it will easily cause excessive inertia and cause the casters at the bottom of the cabinet to jam and the cabinet to fall.
- It is not advisable to push down the slope to prevent the cabinet from falling down due to the shift of the center of gravity. It is recommended

to use a forklift or crane to move the cabinet.

- ITECH 27U and 37U cabinets are equipped with hoisting rings as standard on the top. It is recommended to use a crane equipped with a four-leg hoisting belt structure for horizontal hoisting and moving, and ensure that the four hoisting belts are the same length to avoid cabinet skew during movement. As shown below.
- After moving to the destination, please lock the four casters to secure the cabinet.
- The cabinet should be placed on a level ground. It is forbidden to place the cabinet on a sloped ground.

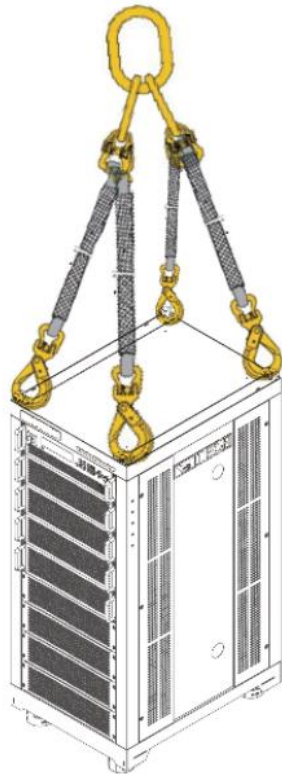

2.2 Verifying the Shipment

Open the package and check the articles within package box before operation. In case of any non-conformity, missing or appearance wearing, please contact ITECH immediately.

The package box should comprise:

Device name	Quantity	Model	Remarks
Programmable AC Power Supply	x1	IT7800H V series	For the specific models included in this series, refer to 1.1 Brief Introduction.
Power Cord	X1	-	Number of the power cords vary depending on the model, See the Section 2.4 Connecting the Power Cord for power cord connection.
USB cable	x1	-	Used for communicating with the PC.
LAN communication	x1	-	Used for communicating with the PC.

cable			
Calibration Certificate	x1	-	Test report before delivery.

NOTE

After confirming that package contents are consistent and correct, please appropriately keep package box and related contents. The package requirements should be met when the instrument is returned to factory for repair.

2.3 Instrument Size Introduction

The instrument should be installed at well-ventilated and rational-sized space. Please select appropriate space for installation based on the power supply size.

IT7800 700V series minimum power unit is 27U cabinet, other models are composed of multiple cabinets in parallel, 27U cabinet size refer to the following.

IT7800 1050V series minimum power unit is 37U cabinet, other models are composed of multiple cabinets in parallel, refer to the following for 37U cabinet dimensions.

700V Model

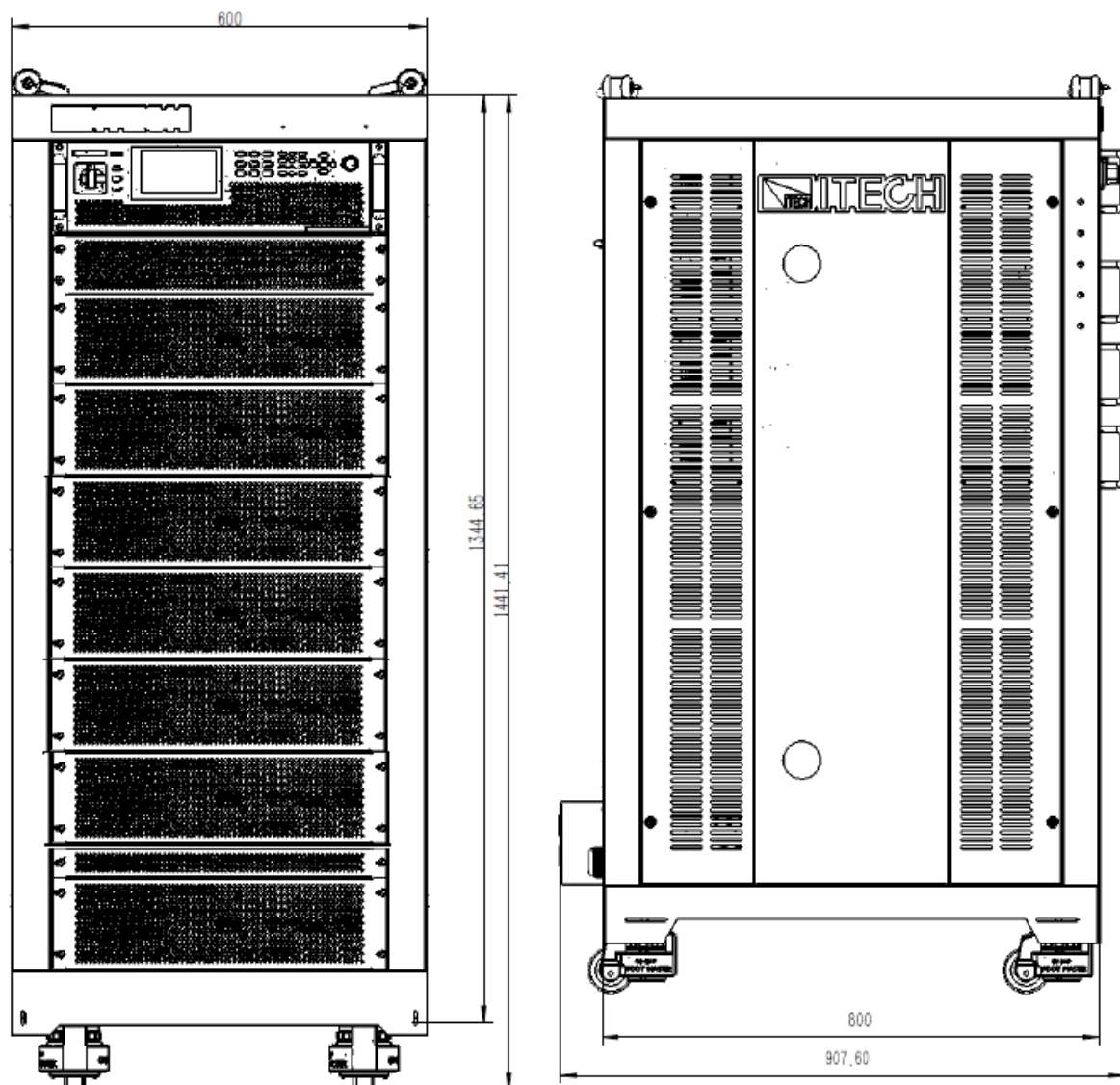

1050V Model

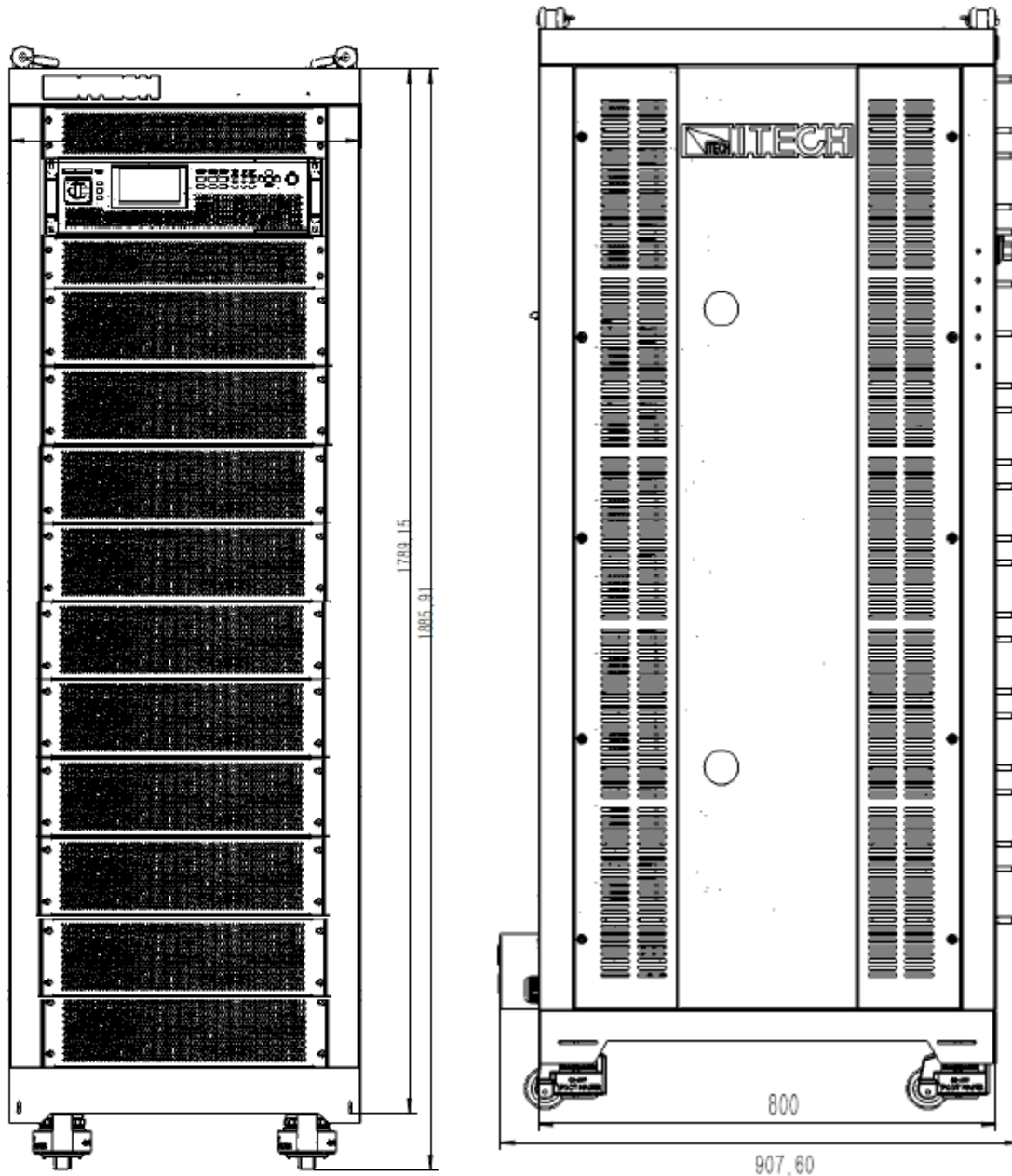

2.4 Connecting the Power Cord

Connect power cord of standard accessories and ensure that the power supply is under normal power supply.

Before connecting the power cord

To prevent electric shock and damage to the instrument, observe the following precautions.

WARNING

- Before connecting power cord, be sure to confirm that the power voltage matches with the rated input voltage of the instrument.
- Before connecting power cord, be sure to switch off the instrument. Verify that there is no dangerous voltage on the connection terminals.
- To avoid fire or electric shock, Make sure to use the power cord supplied by ITECH.
- Be sure to connect the power cord to the AC distribution box with protective grounding. Do not use terminal board without protective grounding.
- Do not use an extended power cord without protective grounding, otherwise the protection function will fail.
- Ensure that the power cord connection terminals are either insulated or covered by the supplied protective cover so that no accidental contact with lethal voltage can occur.

CAUTION

Safety agency requirements dictate that there must be a way to physically disconnect the AC mains cable from the unit. A disconnect device, either a switch or circuit breaker must be provided in the final installation. The disconnect device must be close to the equipment, be easily accessible, and be marked as the disconnect device for this equipment.

Connecting the Power Cord

When the AC input voltage (VLL) is less than 240V, the output power will be derated to 60%, and when the output exceeds the present rating, the instrument occurs protection and the output is turned off. If a full power output is required, the AC input level Voltage must be greater than 240V.

The AC input is three phase and balanced, connecting the power cord as below.

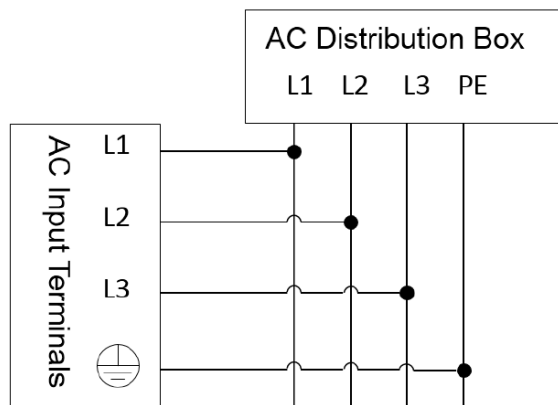

Connecting the power cord

1. Confirm that the switch of the AC power distribution box is off.
2. Confirm that the power switch is in the OFF position and verify that there is no dangerous voltage on the connection terminals.
3. Remove the protective cover outside the AC input terminal on the rear panel.
4. Connect one end of the power cable's round terminal to the AC power input terminal on the instrument's rear panel.

- a) You only need to connect the red/green/yellow (or brown/black/gray) live wires to the terminals on the rear panel, which are not required to correspond to L1, L2 and L3 terminals one by one.
 - b) The yellow-green wire is grounding wire, which is connected to the protective grounding terminal (PE).
5. Mount the protective cover back to its original position.
 6. Refer to the suggestion connection diagram, connect the other end of the power cable to the required AC distribution box.

2.5 Connecting Test Lines (Optional)

Test lines are not standard accessories of the instrument. Please select optional red and black test lines for individual sales based on the maximum current value. For specifications of test lines and maximum current values, refer to “**Specifications of Red and Black Test Lines**” in “**Appendix**”.

WARNING

- Before connecting test lines, be sure to switch off the instrument. Power switch is in Off position. Otherwise, contact with output terminals in rear panel may cause electrical shock.
- To avoid electrical shock, before testing, please make sure the rating values of the testing lines, and do not measure the current that higher than the rating value. All test lines shall be capable of withstanding the maximum short circuit output current of the power supply without causing overheat.
- If several loads are provided, each pair of load wires shall safely withstand the rated short circuit output current of the power supply under full load.
- Always use test lines provided by ITECH to connect the equipment. If test lines from other factories are used, please check that the test line can withstand maximum current.

Specification for Test Cables

Test cables are not standard accessories for the instrument. Please select optional red and black test cables for individual sales based on the maximum current value. For specifications of test cables and maximum current values, refer to [A.1 Specifications of Red and Black Test Cables](#) for more information.

Connecting the DUT (Local Measurement)

The instrument supports two kinds of wiring methods with the DUT: local measurement and remote measurement (SENSE). The default test mode is local measurement.

Please confirm that the Remote Sense function in the menu is set to Off, otherwise the instrument will report an error in the present connection mode.

The connection diagram of three phase is shown as follow: (Take the Y-type method as an example)

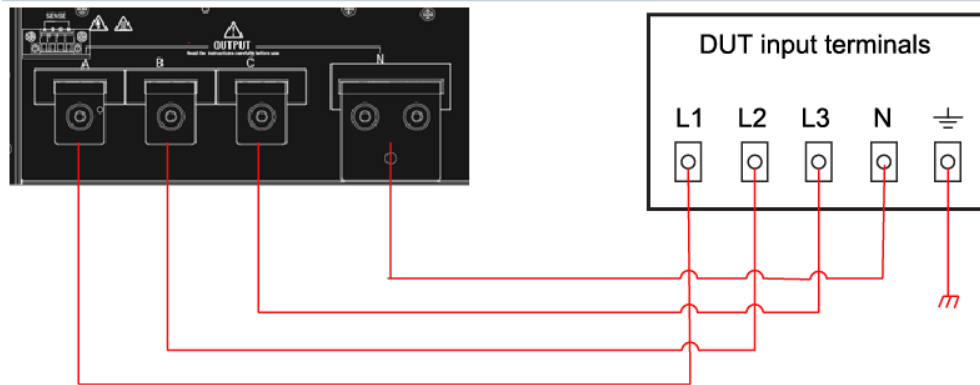

The above diagram shows Y-type wiring as an example, if the user needs Delta-type wiring, please directly suspend the N terminal.

1. Confirm that the power switch is in the OFF position and verify that there is no dangerous voltage on the connection terminals.
2. Remove the output terminals cover of the power system.
3. Loosen the screws of the output terminals and connect the red and black test cables to the output terminals. Re-tighten the screws.

When maximum current that one test cable can withstand fails to meet the rated current, use multiple pieces of red and black test cables. For example, the maximum current is 1,200A, then 4 pieces of 360A red and black cables are required.

4. Thread the red and black test cables through the output terminals cover of the power system and install the cover.
5. (Optional) According to the actual situation of DUT, connect the grounding terminal on the rear panel of the instrument to the DUT to ensure the safe grounding.

For the location information, see 1.5 Rear Panel Introduction.

6. Connect the other end of the red and black cables to the DUT. The positive and negative poles must be properly connected and fastened when wiring.

Connecting the DUT (Remote Sensing)

Remote measurement is available for the following scenarios:

When the DUT consumes large current or the wires are too long, there is a voltage drop on the wires between DUT and output terminals of the power system.

To maximize measurement accuracy, the power system provides the remote measurement terminals VS+ and VS- on the rear panel, which can be used to measure the terminal voltage of the DUT.

When the power system is used for battery testing in actual applications, the voltage drop of the wire will lead to voltage inconsistency of both ends and inconsistency of the cutoff voltage of power system and the actual voltage of battery, resulting in inaccurate measurement.

The connection diagram and steps of remote measurement are as follows:

The connection diagram of three phase is shown as follow: (Take the Y-type

method as an example)

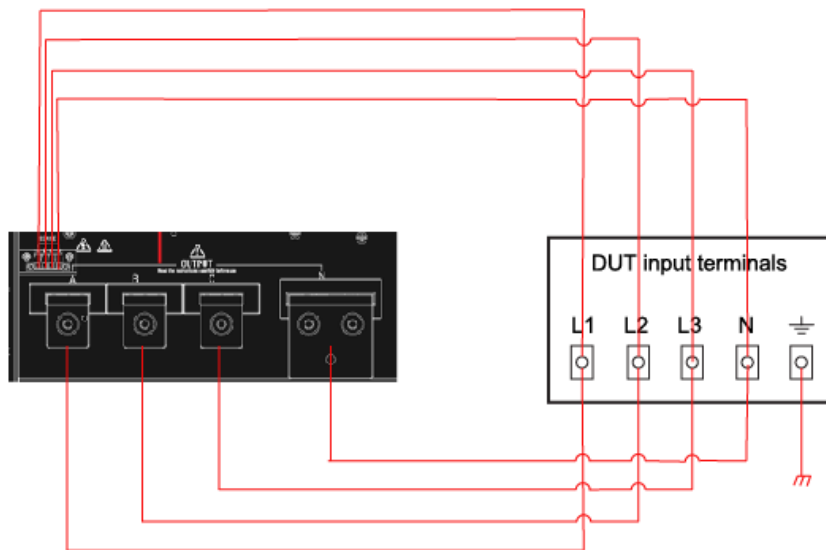

The above diagram shows Y-type wiring as an example, if the user needs Delta-type wiring, please directly suspend the N terminal. And the the N wire of Sense terminal needs to be connected to the N terminal of the output terminal

1. Confirm that the power switch is in the OFF position and verify that there is no dangerous voltage on the connection terminals.
2. Remove the output terminals cover of the power system.
3. Refer to the wiring diagram and connect the Vs+ and Vs- with armored twisted-pair cables. Loosen the screws of the output terminals and connect the red and black test cables to the output terminals. Re-tighten the screws.

When maximum current that one test cable can withstand fails to meet the rated current, use multiple pieces of red and black test cables. For example, the maximum current is 1,200A, then 4 pieces of 360A red and black cables are required.

4. Thread the red and black test cables through the output terminals cover of the power system and install the cover.
5. (Optional) According to the actual situation of DUT, connect the grounding terminal on the rear panel of the instrument to the DUT to ensure the safe grounding.

For the location information, see 1.5 Rear Panel Introduction.

6. Connect the other end of the remote sense cables to the DUT.
7. Connect the other end of the red and black cables to the DUT. The positive and negative poles must be properly connected and fastened when wiring.
8. Power on the instrument and turn on the Sense function of the instrument.

Chapter3 Getting Started

3.1 Power-on the Instrument

A successful selftest indicates that the purchased power product meets delivery standards and is available for normal usage.

Before operation, please confirm that you have fully understood the safety instructions.

Precautions

To prevent electric shock and damage to the instrument, please observe the following precautions.

WARNING

- Before connecting power cord, be sure to confirm that the power voltage matches with the supply voltage.
- Before connecting power cord, be sure to switch off the instrument. Verify that there is no dangerous voltage on the terminals before touching them.
- To avoid fire or electric shock, make sure to use the power cord supplied by ITECH.
- Be sure to connect the main power socket to the power outlet with protective grounding. Do not use terminal board without protective grounding.
- Do not use an extended power cord without protective grounding, otherwise the protection function will fail.
- Ensure that the input electrodes are either insulated or covered using the safety covers provided, so that no accidental contact with lethal voltages can occur.
- If you notice strange sounds, unusual odors, fire, or smoke around or from inside the instrument, flip the POWER switch to the (O) side to turn the instrument off, or remove the power cord plug from the outlet. The detachable power cord may be used as an emergency disconnecting device. Removing the power cord will disconnect AC input power to the unit.

CAUTION

Safety agency requirements dictate that there must be a way to physically disconnect the AC mains cable from the unit. A disconnect device, either a switch or circuit breaker must be provided in the final installation. The disconnect device must be close to the equipment, be easily accessible, and be marked as the disconnect device for this equipment.

Power Switch Introduction

The POWER switch knob of the IT7800HV series power supply is on the left side of the front panel. The user can turn ON the power by 90° clockwise.

Turning the POWER Switch On

Check that the power cord is connected properly.

Flip the POWER switch to the (ON) side to turn the instrument on. The front panel display will light up after a few seconds. It may take about 30 seconds or so for the power supply to initialize before it is ready for use.

If a self-test error occurs, an error message will be displayed in the front panel. Press the **[Esc]** button to try to clear the current fault status. The user can also restart the instrument to try to clear the fault status. Wait until the power is turned off and then start again. If the problem still cannot be solved after restarting, please contact the ITECH engineer.

Turning the POWER Switch Off

Flip the POWER switch to the (OFF) side to turn the instrument off. When it is turned off, the instrument interface will prompt power down, and the instrument will store the setting information before shutdown in the nonvolatile memory.

After you turn the POWER switch off, wait at least 10 seconds after the fan stops before you turn the POWER switch back on. Turning the instrument on too soon after you turn it off can cause damage to the inrush current limiter circuit, as well as reduce the life of components such as the POWER switch and the internal input fuses.

3.2 Touch Screen Introduction

This series of power display is a touch screen LCD interface, users can select and set parameters by hand touch. The touch function can be set in the system menu.

Touch screen drag and corresponding functions are described as below. Convenient user quickly understand how to use this power supply.

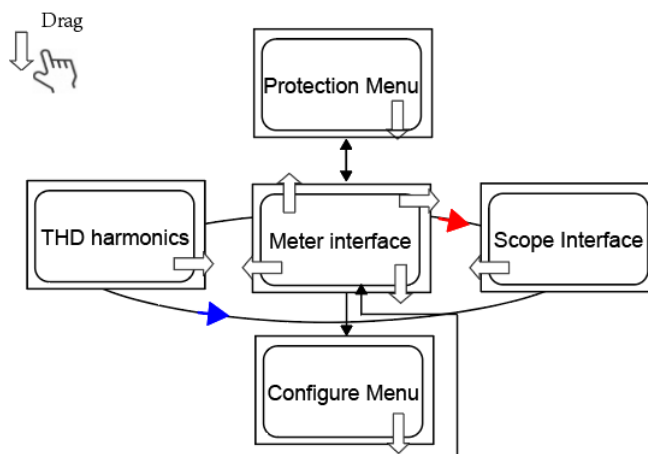

3.3 Set output parameters

The voltage value and frequency value can be programmed, which can be set to different parameters within the specification range based on customer requirements. This can meet various test requirements of the customer.

After the user presses the V-set or F-set keys on the front panel, the instrument interface displays the parameters to be set and the cursor flashes for prompt. The user can use the following methods to set the values.

- Directly use the number keys to set the value.
- Rotate the knob to set the data in the cursor position. Rotate the knob lockwise to increase the set value and anticlockwise to decrease the set value. Once the data in the cursor position increases to ten, the value will add one to the front position automatically, and once the data in the cursor position decreases to zero, the value will minus one from the front position automatically. This provides convenience for the user to set. The knob can works with the left or right keys. Use the left or right keys to move the cursor position.

 NOTE

After entering the menu interface, the knob can also be used to scroll pages to view menu items.

3.4 Output On/Off Control

WARNING

- The **[On/Off]** key is used to turn the output on or off under normal circumstances. Even if the instrument is in control by PC or the keyboard is locked, the **[On/Off]** is still valid for turn off output.
- The **[On/Off]** key light is off and turning the output off does not place the instrument in a safe state. Hazardous voltages may be present on all output and guard terminals. Putting the equipment into an output-off state does not guarantee that the outputs are powered off if a hardware or software fault occurs. See the cautions about connecting the test lines before connecting test lines.

You can press the **[On/Off]** key on the front panel to control the output status of the power supply. If the **[On/Off]** key light is on, indicates that the output is turned on. The VFD displays the meter value such as voltage, current, power and so on. If the **[On/Off]** key light is off, indicates that the output is turned off. The VFD displays that the power supply state is OFF.

Chapter4 Operation and Application

This chapter describes operations of the keys on the front panel of the AC power supply. The AC power supply must be in the local mode when controlled by the front panel. The default mode is the local mode after the AC power supply is turned on. In the local mode, the user can enable all functions of the power supply through the front panel.

4.1 Select the Output Mode

The IT7800 high voltage series has two output modes: AC, AC+DC. It not only provides pure AC output, but also can use AC+DC output mode to realize "AC output plus DC bias", which cover a wider range of applications.

The output mode can be select in the system menu.

1. Press **[Shift]** +  (System) enter to system menu.
2. Under the Source setting interface, touch the screen or rotate the knob to select the **[Output couple mode]** and set the output mode.

4.1.1 AC Output Mode

If the output mode select to AC Mode, the instrument will simulate AC power supply. The default set of IT7800HV series power supply is AC Mode.

Set the output parameters of the power supply in the main interface, including the output voltage, output frequency.

- Press up/down keys to select setting value and then press **Enter** to confirm.
- Rotate the knob to select setting value and then press **Enter** to confirm.
- Touch screen and then press **Enter** to confirm.

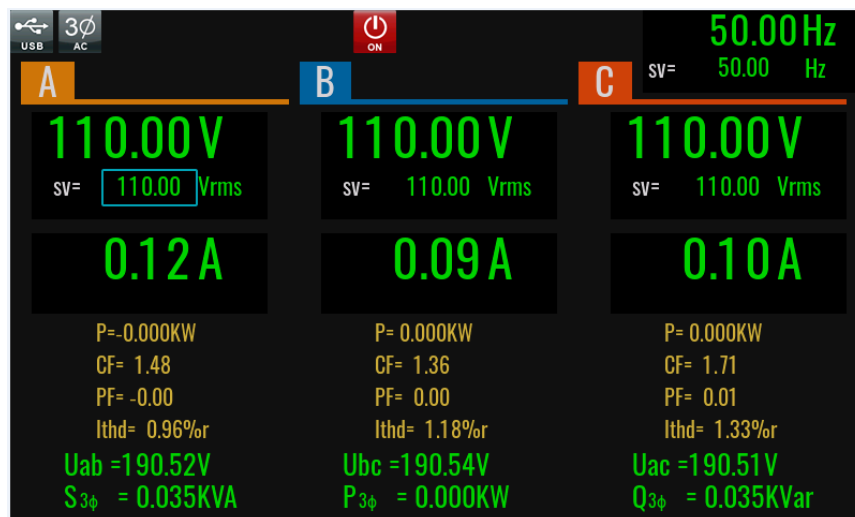

4.1.2 AC+DC Mode

If the output mode select to AC+DC Mode, the instrument will simulate AC and DC power supply, which can add DC component to AC voltage. Set the output voltage in the main interface, as shown in the figure below.

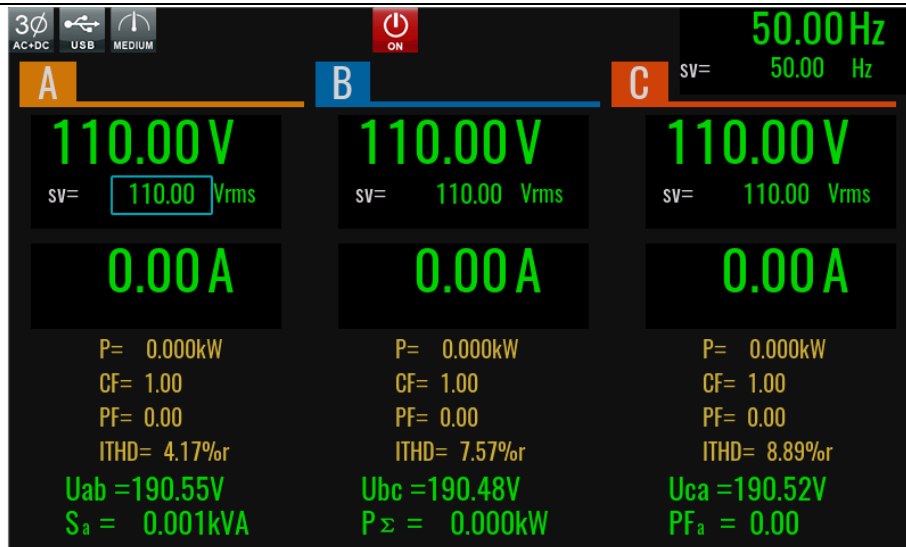

Under AC+DC mode, Set the output voltage and frequency of the AC power supply in the main interface, and set the DC voltage in the configure menu.

Vac: you can set the Vac under the main interface or under the config interface.

DC: set the DC component under the config interface. DC value can not be set in three-phase balance mode. To set the three-phase DC component, turn off the balance mode.

NOTE

The AC + DC mode not only expands the application range of pure AC voltage, but also expands the application range of DC component in laboratory testing. When using AC+DC for testing, please first understand the ripple parameters of the instrument when it is used as a DC power supply. If there are strict noise requirements, additional DC noise filters are needed to obtain low noise and good stable DC voltage for testing.

4.2 Waveform Selection

In AC mode or AC+DC mode, the user can set the output waveform in the config menu of IT7800HV series power supply. Eight output waveforms below are available, user can select the waveform in **Config->Waveform** menu.

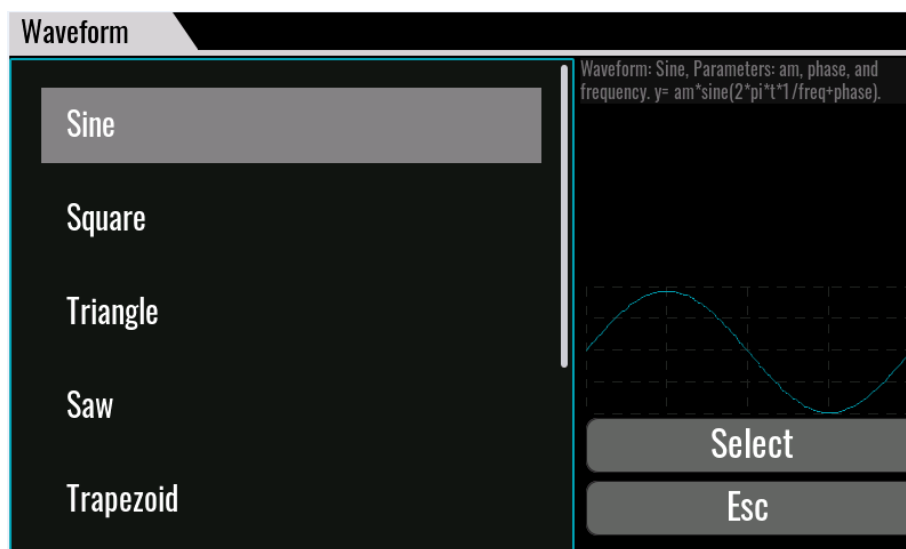

- Sine
- Square
- Sawtooth
- Triangle
- Trapezoid
- Clipped-sine
- Rectifier
- THD wave
- User-defined

When **Trapezoid**, **Clipped-sine**, **Rectifier**, **THD Wave** and **User-define** are selected, the user should configure the parameter of waveform.

4.3 Auto-range Function

IT7800HV series power supply can achieve the combined output of multiple voltage and current at a fixed power. Single power supply can meet different DUT tests with high voltage low current or high current low voltage, at the same time, because the output of voltage and current is controlled by the limit power, it will show the switching of voltage and current auto ranging. To avoid Intermittent output shutdown when switching the high range and low range.

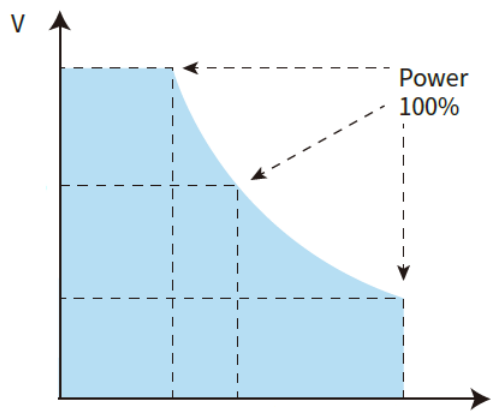

I-V Curve Graph

4.4 Current Limit Mode and Power Limit Mode

The IT7800HV series power supply defaults to constant voltage CV output mode. The output voltage can be set in main interface.

When the actual current value is higher than the setting current limit value, power supply works in current limit mode, and output voltage will be reduce.

When the actual power value is higher than the setting power limit value, power supply works in power limit mode, and output voltage and current will be adjust.

The current limit value can be set in the Protection menu. Refer to 5.6 Protection Function for detailed setting methods.

NOTE

Current limited or power limited operation mode is only valid when pulling load with constant resistance, please contact ITECH engineer for other test situation.

4.5 Sweep Function

The Sweep function is used to test efficiency of power supply and capture the voltage and frequency at the maximum power point. The voltage and frequency of power may be altered in the form of step ladder by setting the initial voltage, final voltage, step voltage, initial frequency, final frequency, step frequency and one-step time.

Operating steps

1. Press **[Shift] + [F-set]** (Sweep) on the front panel to enter the sweep interface, as shown in the figure below.



2. Set the voltage and frequency parameters in the sweep interface. Parameters in the sweep interface are described as follows:

Parameter	Explain
Start voltage	Set the starting voltage.
Stop voltage	Set the ending voltage.
Step Voltage	Set the step voltage.
Start freq	Set the starting frequency.
Stop freq	Set the ending frequency.
Step freq	Set the step frequency.
Step time	Set the step time.
Mode	Set the sweep mode. Time: Time Sweep Mode Trig: Trigger mode Time-back-forth: Step switching according to time and scanning back and forth. Trigger-back-forth: Step switching according to trigger and scanning back and forth.
Priority	Priority setup Volt-Priority Freq-priority Volt&Freq

Parameter	Explain
Waveform	Select sweep waveform Sine Square Sawtooth Triangle Clipped-sine Rectifier Trapezoid THD User-defined
Finish	Set the running state after the sweep execution is finished: <ul style="list-style-type: none"> • off: Directly off the output after the execution is finished; • Last: Keep the last waveform unchanged after the execution is finished. • Normal: return to normal mode after the sweep execution is finished.
Trig source	Select the Trigger source: Manual BUS Trigger1 Trigger2

3. Press **[On/Off]** on the front panel and enable the output.
4. Press **[Run]** on the Sweep interface, Then the running status will be displayed on LCD. Output parameters and measurement parameters are displayed on the left side of the Sweep interface. You can also press the Meter to observe the output parameters in the main interface.
5. After sweeping, **[On/Off]** on the front panel will be off, and status will be displayed on LCD. You can press **[Stop]** on the Sweep interface to stop the Sweep function.

4.6 Power Amplifier

This series regenerative grid simulator can be used as a power amplifier to complete power hardware in the loop (PHIL) applications for microgrids, energy storage and new energy vehicles. The digital I/O or a standard suite of analog signal can be input via an external analog interface (optional) and then amplified without distortion to a real power waveshape.

The power amplifier function can be implemented only when an external analog interface is configured. For details, see 5.14 Analogue Function (Ext-program).

4.7 Programmable Output Impedance

The function of programmable output impedance allows user to edit the output R and L so as to simulate the impedance of the AC grid.

Chapter5 System-Related Functions

5.1 System Menu Reference

Press **[Shift]** +  (System) to enter the menu function. At this time, LCD displays optional menus. Select and edit the menu items by pressing the Up, Down, Left and Right keys. Specific menu items are shown below.

System			
Voltage Source	Device operation mode	Select the operation mode to Voltage Source.	
		Volt Source: Voltage source mode	
	Phase mode	Set the power supply mode	
		3-Phase Three phase mode	
	Output couple mode	Set the output mode	
		AC AC mode	
		ACDC AC+DC mode	
	Output impedance	Set the output impedance	
		Status Enable or disable this function	
		R Set the output resistance	
		L Set the output inductance	
	Off mode	Set the output turn off mode	
		Open-Z Open circuit mode	
		High-Z High impedance mode	
		Short Short circuit mode	
	Loop speed	Output loop speed control	
		High High speed	
		Low Low speed	
	External programme	External analog function:	
		Status Set the ON/OFF state	
		Mode AM: Adjust the amplitude Amplifier: Real-time output and power Amplifier.	
		Monitor phase Select the phase to monitor. This cannot be set in single phase mode.	
		U ratio The external program ratio of voltage.	
		I ratio The external program ration of current.	
	Remote sense	Set the sense function state.	
		Mode On: Enable the remote sense Measurement Off: disable the sense function	
	On/Off phase	On-mode	<ul style="list-style-type: none"> ● Output on phase control ● Phase: setting the phase ● Imm: immediately

			<ul style="list-style-type: none"> ● Slope: Controlled according to the set slope
		Off-mode	<ul style="list-style-type: none"> ● Output off phase control ● Phase: setting the phase ● Imm: immediately ● Slope: Controlled according to the set slope
	Measurement	Set the measurement speed	
		Lowest (1Hz)	Lowest mode, measuring every 2s
		Lower (1000ms)	Lower mode, measuring every 1000ms
		Slow (500ms)	Slow mode, measuring every 500ms
		Medium (300ms)	Medium mode, measuring every 300ms
		Fast (150ms)	Fast mode, measuring every 150ms
		Filter	Whether to turn on the filter during measurement.
	Power Unit Setting	Unit of power, can be set to KW/kVA/KVar or W/VA/Var.	

General Menu:

General	Buzzer	Set the keyboard sound.	
		Key	Buzzer on/off for key
		Protect	Buzzer on/off for protect
	Brightness	Set the screen brightness.	
		1-10	Set the screen brightness level
	Factory-default-settings	Select whether to reset the factory default settings or not.	
		Enter	Confirm to reset operation
	Power-on setup	Set the power-on state.	
		Reset	When the instrument is powered on, the instrument will initialize some settings and [On/Off] state.
		Last	When the instrument is powered on, the instrument will remain the same settings and [On/Off] state as last time you turned off the instrument.
		Last-OFF	When the instrument is powered on, the instrument will remain the same settings as last time you turned off the instrument, but the [On/Off] is OFF state.
	Parallel mode	Set the instruments to parallel operation mode.	
		Role	<ul style="list-style-type: none"> ● Master: Set the instrument to master mode. ● Single: Set the instrument to single mode, i.e., disable the parallel operation mode. ● Slave: Set the instrument to slave mode.

	Numbers	Number of parallel instruments.
Touch function	Lock the touch screen function	
	Status	Set the ON/OFF state
Knob immediately effective	Knob setting will take effect immediately. If set to ON, the Knob setting will take effect immediately. If set to OFF, press ENTER to confirm the effect after the Knob setting is completed.	
Language	Set the language of display	
	English	English
	Chinese	Chinese
Soft keyboard	Set the soft keyboard	
	On	Turn on the soft keyboard.
	Off	Turn off the soft keyboard.

Communication Menu:

Communication	USB type	Set the USB type.	
		Device: the USB device is used to communication with PC.	
		Host: the USB device is used to storage disk.	
	USB device class	USB communication interface	
		VCP	Virtual serial port
		TMC usbtmc	USB-TMC protocol
	LAN config	LAN communication interface	
		Mode	<ul style="list-style-type: none"> ● DHCP: automatically configure the address of the instrument. ● Manual: manually configure the address of the instrument by entering values in the following five fields.
		IP	Set the IP address.
		Mask	Set the subnet mask.
		Gateway	Set the gateway address.
		Port	Set the port number.
	CAN Config	Baud rate	Baud rate
		Addr	Address
	RS232 config	Select RS-232 communication interface. When insert IT-E177 communication board into expansion slot, the menu displays this information.	
		Baud rate	Baud rate
		Databits	Data bit: 5/6/7/8
		Stopbits	Stop bit: 1/2
		Even-odd check	Parity bit: N (No parity) / E (Even parity) / O (Odd parity)
		Addr	Address
GPIB config	Select GPIB communication interface. When insert IT-E176 communication board into expansion slot, the menu displays this information.		
	Addr	Set the communication address	
IO	Digital IO-1:Remote Inhibit Input	Function setting of pin 1	

	Reverse	On/Off, Select Invert or not under the IO Settings. If setting to ON, it means the valid signal is reversed.
	Function	<ul style="list-style-type: none"> ● Inhibit-living ● Inhibit-latch ● Input ● Output
Digital IO-2: PS Clear	Function setting of pin 2	
	Reverse	On/Off, Select Invert or not under the IO Settings. If setting to ON, it means the valid signal is reversed.
	Function	<ul style="list-style-type: none"> ● PS Clear ● Input ● Output
Digital IO-3: PS	Function setting of pin 3	
	Reverse	On/Off, Select Invert or not under the IO Settings. If setting to ON, it means the valid signal is reversed.
	Function	<ul style="list-style-type: none"> ● PS ● Input ● Output
Digital IO-4: SYNC	Function setting of pin 4	
	Reverse	On/Off, Select Invert or not under the IO Settings. If setting to ON, it means the valid signal is reversed.
	Function	<ul style="list-style-type: none"> ● Sync-in ● Sync-out ● Input ● Output
Digital IO-5: ON/OFF Status	Function setting of pin 5	
	Reverse	On/Off, Select Invert or not under the IO Settings. If setting to ON, it means the valid signal is reversed.
	Function	ON/OFF Status Input Output
Digital IO-6: Trigger1	Function setting of pin 6	
	Reverse	On/Off, Select Invert or not under the IO Settings. If setting to ON, it means the valid signal is reversed.
	Function	<ul style="list-style-type: none"> ● Trigger1-out ● Trigger1-in ● Input ● Output
	AC	On/Off: When On is selected, a trigger signal is output when AC amplitude changes. The accuracy of voltage change is 100mV and is not restricted by phase. (This configuration is displayed only when the IO function is set to Trigger1-out)

		DC	On/Off: When On is selected, a trigger signal is output when the DC amplitude changes, and the voltage change precision is 100mV. (This configuration is displayed only when the IO function is set to Trigger1-out)
		Freq	On/Off: When On is selected, a trigger signal is output when the frequency changes. The accuracy of frequency change is 0.1Hz (This configuration is displayed only when the IO function is set to Trigger1-out)
		List	On/Off: When On is selected, a trigger signal is output when the List generates a trigger signal. (This configuration is displayed only when the IO function is set to Trigger1-out)
	Digital IO-7: TRIG2	Function setting of pin 7	
		Reverse	On/Off
		Fun	Trigger1-out Trigger1-in Input Output
		AC	On/Off: When On is selected, a trigger signal is output when AC amplitude changes. The accuracy of voltage change is 100mV and is not restricted by phase. (This configuration is displayed only when the IO function is set to Trigger2-out)
		DC	On/Off: When On is selected, a trigger signal is output when the DC amplitude changes, and the voltage change precision is 100mV. (This configuration is displayed only when the IO function is set to Trigger2-out)
		Freq	On/Off: When On is selected, a trigger signal is output when the frequency changes. The accuracy of frequency change is 0.1Hz (This configuration is displayed only when the IO function is set to Trigger2-out)
		List	On/Off: When On is selected, a trigger signal is output when the List generates a trigger signal. (This configuration is displayed only when the IO function is set to Trigger2-out)

		Pulse Width	Range: 30us-500us
Information	Product model	Display the instrument model.	
	Serial number	Display the serial number.	
	Software version	Display the control board version.	
	MAC address	MAC address	
	Rbf Version	Rbf version	
	Ctrl1 version	Ctrl1 version	
	Ctrl2 version	Ctrl2 version	
	Hardware version	Hardware version	
	Inner numbers	The inner numbers setting item is required when using F-TX and F-RX fiber to achieve master-slave model parallel.	

5.1.1 Menu function

Set OFF Mode Status

This parameter is used to set the status after the power output is off.

- Select to High-Z, After the power output is Off, the dc impedance between the terminals of the power supply is high, and the resistance value varies with different models.
- Select to Short, When the power output is Off, the terminals of the power supply are short-circuited, the voltage is 0.
- Select to Open-Z, After the power output is Off, the power supply is in open mode, and the internal circuit and external load of the power supply are disconnected by relay.

Set the buzzer

This item can set the key sound state. If in ON mode, then when you press a button or occur protection, the power supply will beep. If in OFF mode, the beeper will not make a sound. The default set is in ON mode.

Set the screen brightness

This item can set the screen brightness. Set the screen brightness within the range 1 to 10 by pressing number keys on the front panel. The larger the number is, the higher the screen brightness is. You can also set the screen brightness by rotating the knob on the front panel.

Restored to Factory Setting

This menu item is used to restore some parameter settings to factory setting values.

The procedures to set the menu item are as follows.

1. Select the **General** under system menu.
2. Press **Enter** in **Factory_default_settings**. After the parameter settings are complete and return to main interface.

Set the Power-on State

This parameter determines the state of the AC source after power up.

The procedures to set the menu item are as follows.

1. Press the **General** under the system menu.
2. Press the Up/Down key or turn the knob to select the **Power-on setup** and press **[Enter]**.
 - Reset: Default value, indicates when the instrument is powered on, the instrument will initialize some parameter settings or state.
 - Last: Indicates when powered on, the instrument will remain the same parameter settings and output status as last time you powered off the instrument.
 - Last+Off: Indicates when powered on, the instrument will remain the same settings as last time you powered off the instrument, but the output status is **Off**.

Lock the Touch Screen

This parameter determines the state of the touch screen.

1. Press the **General** under the system menu.
2. Press the Up/Down key or turn the knob to select the **Touch screen lock** and press **[Enter]**.
 - On: enable the touch screen
 - Off: disable the touch screen

Set the Loop Speed

This item can control stability of the loop. When the connected load is capacitive load or inductive load, select Slow; when the connected load is resistance, select High.

Set the Knob Function

Set the knob setting function. If set to ON, the Knob setting will take effect immediately. If set to OFF, press Enter to confirm the effect after the Knob setting is completed.

Select Language

Users can select the instrument language type from the menu, supporting Chinese and English.

Set the Soft Keyboard

The user can open the soft keyboard in the menu. When the parameter is set to ON, the soft keyboard is enabled. And when setting parameters on the screen, the soft keyboard appears. Convenient users directly touch screen to select the number.

5.1.2 Set the communication interface

This menu item is used to set the communication information between instrument and PC. The standard communication interfaces for IT7800HV series power supply are USB, LAN and CAN. You can also select the non-standard interface GPIB or RS-232 based on personal requirement.

The user does not need to select the communication interface. The instrument will automatically select the present communication mode according to the communication interface accessed by the rear panel. The user only needs to set the communication parameters and keep them consistent with the PC Settings.

 NOTE

- When select USB interface, the USB type need to be DEVICE.
- The instrument supports the non-standard RS-232 and GPIB interfaces, and the configuration items in the menu are dynamically displayed according to the interface user selected

5.1.3 View the System Information

System Information menu is used to view the system information of the instrument. Include product model, SN, software version and MAC address.

5.2 Configuration Menu Reference

Press [**Config**] key and enter to configuration menu interface. At this interface, user can setup the power supply output parameters, detailed parameters are shown as follows:

AC Config	Configuration setting for AC mode	
	Balance control	Only displayed in 3-phase mode. Balance control in 3-phase mode. If select On, the output of ABC phase is synchronous. If select Off, the output is not balanced.
	Voltage AC	Output voltage Vac: output voltage of AC, range from 0-full scale Slew Rate: Slope , range from 0.0001-5000V/ms
	Frequency	Freq: output frequency, range from 16-100Hz Slew Rate: slope, range from 0.00001-5000Hz/ms
	Phase control	Phase difference between AB and AC, only valid in balance control is Off state. AB: Phase difference between A and B. AC: Phase difference between A and C.
	Waveform	Selece and edit the output wave type. For detailed introduction please refer to 4.3 waveform selection.
	Dimming	Status: Dimming function switch. Edge: select front edge or back adge Phase: phase control, range from 0-180°
AC+DC Config	Configuration setting for AC+DC mode	
	Balance control	Only displayed in 3-phase mode. Balance control in 3-phase mode. If select On, the output of ABC phase is synchronous. If select Off, the output is not balanced.
	Voltage AC	Output voltage Vac: output voltage of AC, range from 0-full scale Slew Rate: Slope , range from 0.0001-5000V/ms

	Voltage DC	Output voltage of DC, range from 0-full scale Slew Rate: Slope , range from 0-5000V/ms
	Frequency	Freq: output frequency, range from 16-100Hz Slew Rate: slope, range from 0.00001-5000Hz/ms
	Waveform	Select and edit the output wave type. For detailed introduction please refer to 4.3 waveform selection.
	Dimming	Status: Dimming function switch. Edge: select front edge or back adge Phase: phase control, range from 0-180°

Balance Control Setting

In three-phase mode, the instrument is in three-phase balance mode by default, and the three-phase output voltage will be set synchronously, and the phase Angle between phases is fixed at 120°, which cannot be set.

You can set the Balance Control to Off and disable the Balance control function in the Config menu. And then, the voltage of each phase can be set independently, and the config menu displays the phase Angle difference setting parameter between AB and AC.

Dimming Function

The front and back edge of the waveform can be concealed and the phase angle set with Dimmer function to regulate the active power, thus adjusting the lighting intensity.

Select Front edge, and phase set to 90° in Configuration menu.

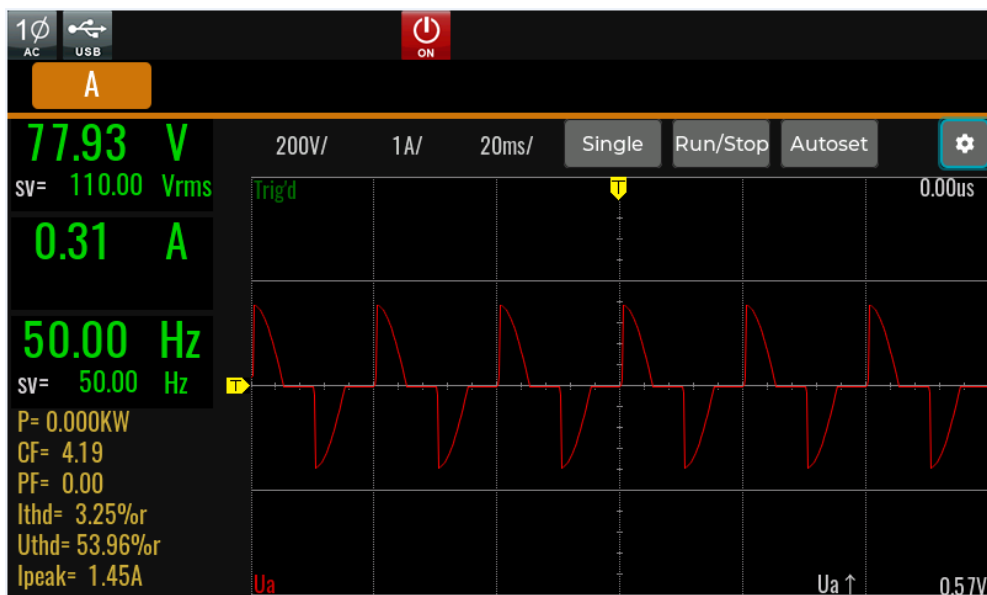

Select Back edge, and phase set to 90° in Configuration menu.

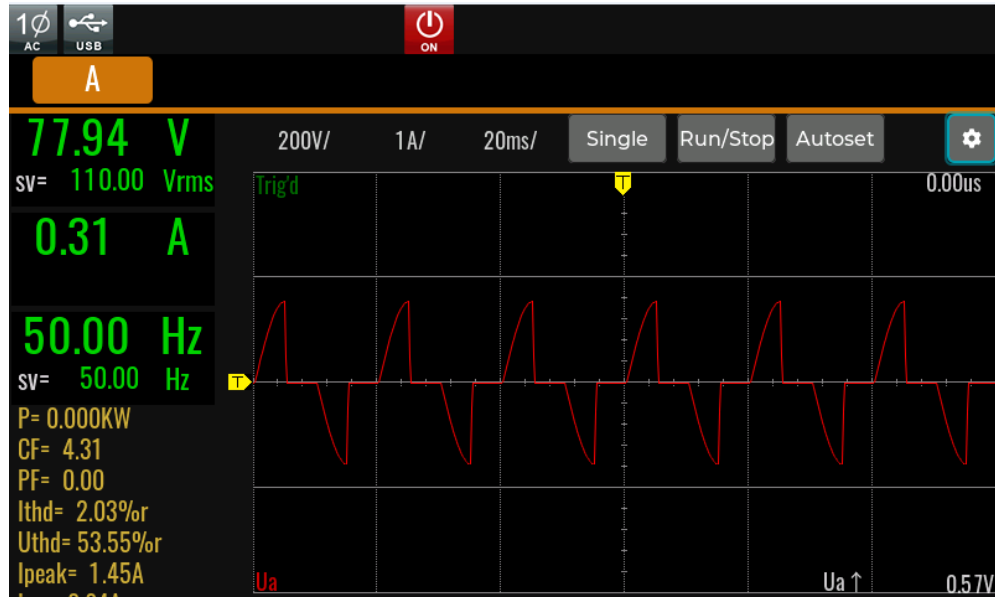

5.3 Key Lock Function

Press **[Shift] + [2]** (Lock) button to set the key lock state. If keyboard has been locked, the indicator light "Lock" will display on the LCD. In addition, when the keyboard are locked, all buttons can't be used, Press **[Shift] + [2]** (Lock) once again will relieve key lock function.

5.4 Switching Local/Remote Mode

You can press the **[Shift] + [3]** (Local) button to change the AC source from remote to local operation.

After you power on the AC source, it defaults in local mode, all buttons are enabled. While in remote mode, most buttons are disabled except **[Shift] + [3]** (Local) keys. You can switch Local/Remote mode via PC. In addition, the mode modification will not affect the output parameters.

5.5 Save and Recall Operations

The power system can save up to 10 common parameters in nonvolatile memory (No. 1 to No. 10) for user to recall conveniently.

The saved parameters include:

- Power supply mode
- Present output mode
- Config menu settings

You can do the save and recall operations by the following two methods.

- Press the composite keys **[Shift]+[4]** (Save) to save the parameters. Press the composite keys **[Shift]+[5]** (Recall) to recall the parameters.
- SCPI commands: *SAV and *RCL

Save Operation

The save operation procedures are as follows:

1. Press the composite keys **[Shift]+[4]** (Save) to enter the parameter save

interface.

2. Select the storage location. up to 10 position can be select.



3. Press **[Enter]** to save the parameters.

Finished, the saved parameters will be display at the bottom of the interface.

Recall Operation

You can recall the parameters you saved in the specified memory location as the setting values.

1. Press the composite keys **[Shift]+[5]** (Recall) to enter the parameter recall interface.
2. Set the storage location.
Press the direction keys to set the storage location, and then, the saved parameters will be display at the bottom of the interface.
3. Press **[Enter]** to recall the parameters.

5.6 Protection Function

IT7800HV series source includes the following protection functions: overcurrent protection (Current RMS protection, Current peak protection), voltage limit protection and over-temperature protection (OTP).

AC/ACDC Mode

Press **[Shift]+[Config]** (Protect) and enter to **Protect** configure menu, where you can set the following protection.

Current RMS protection	RMS current for OCP protection	
	Rms	Protection point
	Time	delay time of protection
	Type	Protection type.
		Limit Output Disable
Current peak protection	Current Peak OCP	

	Peak	Protection point
	Time	delay time of protection
Voltage max protection	Voltage max	protection
	Max	Max voltage
	Time	delay time of protection
Voltage peak range	Voltage limit	setting
	V limit	Maximum voltage setting
Power limit range	Power limit	setting
	P limit	Power limit point
	Time	delay time of protection
	Type	Protection type. Limit Output Disable

5.6.1 Current RMS Protection

The user can set the over-current protection point, delay time and protection type for the Current RMS protection function. The function is mainly used to protect the DUT connected during test to prevent it from damage due to over-current. The OCP (rms) function is always enabled.

RMS OCP Type:

- Limit: If the output current reaches the RMS current protection point, the protection will be activated. The power supply output current is controlled within the current limiting value. The power supply will output in current limit mode.
- Output Disable: When the output current reaches the over-current protection point and the period is greater than the set protection delay time, the over-current protection (rms) will turn off the output.

How to Set

1. Press [Shift]+[Config] (Protect) keys and enter to Protection menu.
2. Press the up/down key or rotate the knob to select Current RMS protection and press [Enter].
3. Set the protection RMS Level, the delay time and protection type in sequence, and press [Enter] to confirm.

Clear RMS OCP Protection

When RMS OCP protection occurs, the instrument responds as follows:

- Instrument output is off;
- The buzzer sounds;
- The interface displays “OCPrms” and flashes

To clear the RMS OCP and return to normal operation, firstly remove the conditions that caused the protection fault. Press **[Shift] +[Esc]** key (or send the command PROTECT:CLEAR) to clear the protection status. The message displayed in front panel is cleared and the instrument exits protection status.

5.6.2 Set the Current Peak protection

The user can set the current peak protection point and delay time for the Current peak protection function. The function is mainly used to protect the DUT connected during test to prevent it from damage due to over load. The OCP

peak function is always enabled.

How to Set

1. Press [Shift]+[Config] (Protect) keys and enter to Protection menu.
2. Press the up/down key or rotate the knob to select Current peak protection and press [Enter].
3. Set the protection peak Level and the delay time in sequence, and press [Enter] to confirm.

Clear Peak OCP Protection

When peak OCP protection occurs, the instrument responds as follows:

- Instrument output is off;
- The buzzer sounds;
- The interface displays “OCPpeak” and flashes

To clear the peak OCP and return to normal operation, firstly remove the conditions that caused the protection fault. Press **[Shift]+[Esc]** key (or send the command PROTECT:CLEAR) to clear the protection status. The message displayed in front panel is cleared and the instrument exits protection status.

5.6.3 Set Voltage/Current/Power Limit Range

The maximum voltage, current and power of the power supply ranges from minimum to full-rated output range. You can setting maximum and minimum values of power supply voltage/current/power in the protection menu. When limit setting is finished, the voltage setting value, current setting value and power setting value can only be set within the maximum and minimum limits.

Limit factory setting is the rated output voltage/current/power of corresponding model of the power supply. Minimum is 0.

Take the voltage limit setting for an example, the operating as follows:

1. Press **[Shift]+[Config]** (Protect) keys and enter to Protection menu.
2. Press the up/down key or rotate the knob to select Voltage limit range and press **[Enter]**.
3. Set the V+ limit and the V- limit in sequence, and press **[Enter]** to confirm.

5.6.4 Over-temperature protection (OTP)

When the temperature of the power component in the power supply exceeds 95°C, the temperature protection will be enabled. In this case, the power supply will be automatically OFF, and the LCD will display . At the same time, the OT position in the status register will be set and kept until power supply is reset.

Clearing over-temperature protection:

When the power supply temperature decreases to the protection temperature, press **[Shift]+[Esc]** key on the front panel (or send the command “PROTECT:CLEAR”). Then  on the power supply screen will disappear, and the power supply will exit the OTP status.

5.6.5 Over-power protection (OPP)

When the output power exceeds the set power, OPP will be enabled, and  will appear on the LCD screen.

Clearing over-power protection:

In the case of over-power protection, disconnect the tested object at first. Press **[Shift]+[Esc]** on the front panel (or send the command "PROTECT:CLEAr") to clear  on the front panel and exit the OPP mode.

5.7 Screen Capture Function

This series power supply has the screen capture function. Insert the USB disk into the USB interface of the front panel, and press **[Print]** on the front panel to capture and save the current screen into the USB disk.

When you need the screen capture function, the USB type under the system menu needs to be set to **Host**. And the USB interface of real panel can not be connected.

5.8 Trigger Function

This series has four trigger source to choose: trigger by keys (Key), Software trigger (Software), Bus trigger (Bus) and External signal trigger (External).

- Manual: if **[Trig]** on the front panel is pressed in the valid key trigger mode, the power supply will be triggered once.
- Bus: if the bus trigger command is received by the power supply in the valid bus trigger mode, the power supply will be triggered once.
- Trigger1: if one trigger signal is connected to the Digital IO-6 of digital I/O Interface terminal on the rear panel, the power supply will be triggered once.
- Trigger2: if one trigger signal is connected to the Digital IO-7 of digital I/O Interface terminal on the rear panel, the power supply will be triggered once.

5.9 Query the System Log

The IT7800HV series power supply provides the system operation Log query function. On the Menu interface of the front panel of the instrument, click Log or directly press Shift +1[Log] to enter the Log query interface. You can view historical system operation records on this screen.

5.10 Query the Energy

This series power supply provides the energy statistics function. Click WHours button in the Menu interface of the front panel of the instrument to enter the quantity query interface. You can view power statistics on this screen.

- Positive electrical energy: Statistical value of output power by the present phase as a power supply
- Negative electrical energy: Statistical value of sink power by the present phase as a load
- Total positive electrical energy: Statistical value of output power by the three phases in total
- Total negative electrical energy: Statistical value of sink power by the three phases in total

5.11 Remote Measurement Function

The IT7800HV series power supply supports two connection methods: Local

measurement and Remote sensing. The remote sensing is used for maximizing measurement accuracy. (Refer to 2.5 Connecting Test Lines).

The procedures to set the menu item are as follows.

1. Press the composite keys [Shift] +  (System) on the front panel to enter the system menu.
2. Press the up/down key or rotate the knob to select **Source** and press **[Enter]**.
3. Press the up/down key or rotate the knob to select **Remote Sense** compensation and press **[Enter]**.
 - Off: Default value, indicates turn the sense function off.
 - On: Indicates turn the sense function on.
4. After the parameter settings are complete, press **[Enter]**.

5.12 Digital I/O Function

This series power supply supports digital I/O function. The user can realize logic control over high and low level input or output by related configurations in the system menu.

Pins Introduction

Different I/O implements different functions. The detailed functions description are shown in the figure below:

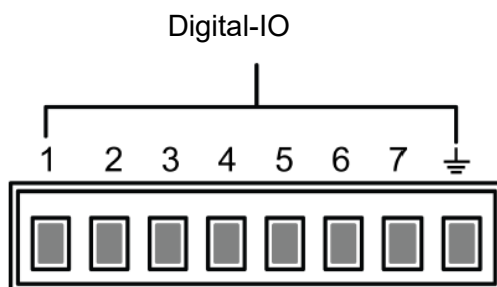

Pin	Type	Description	Properties
Digital IO-1	Input/Output	Inhibit, Turn off the output under emergency status	Level signal
Digital IO-2	Input/Output	Ps-clear, Clear the protection state	Pulse signal
Digital IO-3	Input/Output	PS, Protection state indicator	Level signal
Digital IO-4	Input/Output	Sync, synchronous control	Pulse signal
Digital IO-5	Input/Output	OnOff-status, OnOff-status indicator	Level signal
Digital IO-6	Input/Output	Trigger1	Pulse signal
Digital IO-7	Input/Output	Trigger2	Pulse signal
	Ground terminal, that is, the negative terminal corresponding to each of the above 7 pins.		

General Digital I/O Function

- Signal definition

Digital I/O functions involve input and output levels and pulse signals. The input signal is the control signal provided externally to IT7800HV, the output signal is the level signal provided externally by IT7800HV, and the pulse signal is the edge signal switched between high and low levels.

Input signal	High level signal	Typical: 5V Range: 1.6V-15V Current: ≤100mA
	Low level signal	Typical: 0V Range: -5V-0.8V Current: ≤100mA
Output signal	High level signal	Voltage level: 5V Current: ≤1mA
	Low level signal	Voltage level: 0V Current: 0.5mA
Pulse	Level rise slope	10us
	Level fall slope	2us
	Width	User defined, range: 30us-500us

- Input/Output Function

The IO-1 ~ IO-7 pins are featured default function, the user can setting the function of pin according to requirement. The Input and Output are the general digital I/O function, and the parameter settings and functions of the

seven pins are the same.

The IO-1~IO-7 pins provide default functions. Users can realize control according to the functions defined. Users can also reset the input or output properties of the present pin and customize the function use of the pin according to their needs.

When pins 1 to 7 are configured to Output function, when send the command (IO:STATE <1~7>, <0|1>) to instrument, the IO pin can output high level (False) or low level (True).

When pins 1 to 7 are configured to Input function, an external signal can be Input to this pin, and the instrument can detect the state of the external signal.

- Signal Revert

Select Invert or not under the IO Settings menu. If setting to OFF, it means the default level will be valid. If setting to ON, it means the valid signal is reversed. For example, the IO-1 pin is inhibit output by default and the high level is valid, when select revert ON, the low level is valid and the instrument output is disabled.

Digital IO-1

IO-1 pin can be set to **【Inhibit-latch】**, **【Inhibit-living】**, **【Input】**, **【Output】**

The default function is inhibit output. When the IO pin is configured for a Inhibit function and the level signal is low, the output of the machine is forbidden. At this point, Pin 1 has a bi-directional I/O function, which can both receive the level signal input from the external instrument and output the level signal outward. default level is high, and low is valid when entering. Outgoing output also generates low level signals.

Inhibit function has two mode: Latch and Living.

- Living: When input an inhibit signal and the instrument output is turned OFF. The status bar of the LCD screen displays INH warning icon and the output is marked as OFF. If power supply output is ON state before, the ON/OFF button will be lit. When the input signal undoes, the output returns to normal. This function can be used to control the output of the power supply.
- Latch: When input an inhibit signal and the instrument output is turned OFF. The ON/OFF button will be lighted off, the status bar of the LCD screen displays INH warning icon. In this case, user need to remove the input signal and press **【Shift】+【Esc】** to clear protection, then manually turn on [On/Off] again.

Digital IO-2

IO-2 pin can be set to **【PS-clear】**, **【Input】**, **【Output】**

The default function is to clear the protected state. When the protection occurs, the protection state can be cleared through this pin, so that the instrument can continue to output normally.

IO-2 is bi-directional, that is, when the power supply is in a protected state, the instrument can receive a pulse signal from an external input through IO-2 for clean protection operation, or when the power supply is in a protected state, the clean protection can generate a pulse signal from IO-2.

Digital IO-3

IO-3 pin can be set to **【PS】**, **【Input】**, **【Output】**

The default function is protection state indicator. IO-3 pin will output high or low level based on whether the instrument is under protection or not. Under normal conditions (Not under protection), and when pin3 is under default setting (Not Invert), pin 3 outputs high level; when the instrument is under protection, pin 3 outputs low level. When pin3 is set to Invert, the output level is completely opposite.

Digital IO-4

IO-4 pin can be set to **【Sync-in】** , **【Sync-out】** , **【Input】** , **【Output】**

This function can be used to simulate the six-phase output mode, in which one IT7800HV outputs a synchronous signal to another IT7800HV, and the second power supply runs synchronously with the frequency and phase of the first power supply to realize the six-phase output function.

【Sync-in】 : Synchronous input function, which is used to output frequency lock or phase lock with the external signal. At this time, the machine synchronizes the frequency or phase information input from the IO-4 pin.

【 Sync-out 】 : Synchronous output function, the IT7800HV produces synchronous signal to the outside, which is AC zero crossing pulse signal sent from the IO port.

Digital IO-5

IO-5 can be set to **【OnOff-status】** , **【Input】** , **【Output】**

The default function is to indicate the output state of the power supply, in case of output is ON, output 5V, otherwise, output 0V.

When pin5 is set to Invert, the output level is completely opposite.

Digital IO-6

IO-6 can be set to **【Trigger1-in】** , **【Trigger1-out】** , **【Input】** , **【Output】**

【Trigger1-in】 : The input trigger signal, the pulse signal sent to the IO-6 pin can be used as the trigger source. Users can select as the trigger source of the corresponding function in the menu.

【Trigger1-out】 : The output trigger signal, when the instrument generates a trigger signal, the pin6 generates an pulse signal.

Digital IO-7

IO-7 can be set to **【Trigger2-in】** , **【Trigger2-out】** , **【Input】** , **【Output】**

【Trigger2-in】 : The input trigger signal, the pulse signal sent to the IO-6 pin can be used as the trigger source. Users can select as the trigger source of the corresponding function in the menu.

【Trigger2-out】 : The output trigger signal, when the instrument generates a trigger signal, the pin7 generates an pulse signal.

5.13 Analogue Function (Ext-Program) (Optional)

The interface expansion slot provided on the rear panel of the IT7800HV series. This function is not standard with the instrument and is optional for users.

When the interface card selected by the user is RS232+Analog interface (IT-E177), the analog interface can realize the external analog function.

- Remotely control voltage
- Power amplifier function
- Remotely monitor voltage and current values

The pins description is as below.

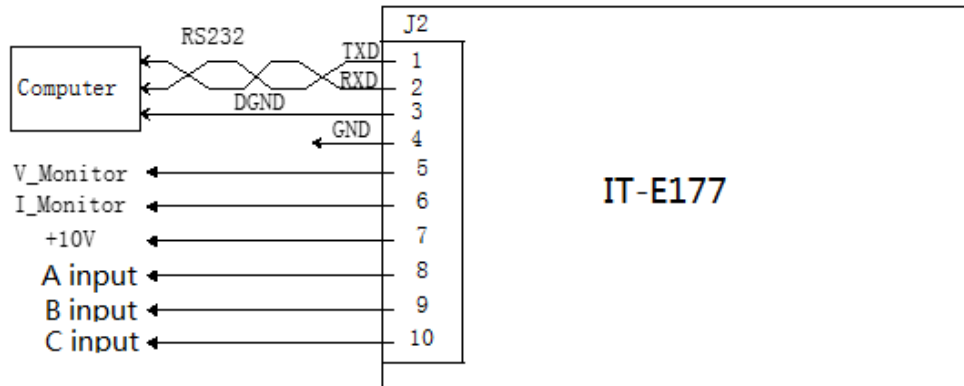

Pins	Name	Description
4 pin	GND	Grounding of analog signals,
5 pin	V_Monitor	Monitor voltage.
6 pin	I_Monitor	Monitot Current.
8 pin	A input	Set the voltage of A phase. When output is DC, $-10V \sim 10V$ voltage value to set the voltage between negative full range and positive full scale. When output is AC, 0-10V voltage value to set the 0 to full scale.
9 pin	B input	Set the voltage of B phase. When output is DC, $-10V \sim 10V$ voltage value to set the voltage between negative full range and positive full scale. When output is AC, 0-10V voltage value to set the 0 to full scale.
10 pin	C input	Set the voltage of C phase. When output is DC, $-10V \sim 10V$ voltage value to set the voltage between negative full range and positive full scale. When output is AC, 0-10V voltage value to set the 0 to full scale.

Enable/disable analog control

The user needs to select the corresponding function settings in the System menu. The detailed parameter description is as below.

External program	External analog function	
	Status	Set the ON/OFF state
	Mode	<ul style="list-style-type: none"> ● AM: Adjust the amplitude ● Amplifier: Monitor the real-time output values
	Monitor phase	When under 3-phase mode, select the phase to be monitor. Invalid under single phase mode.
	U ratio	Set the ratio between the external signal and the output voltage. Can be set to 50V/1 or 100V/1
	I ratio	Set the ratio between the external signal and the output voltage. Can be set to 5A/1 or 10A/1

1. Press the composite keys [Shift] +  (System) on the front panel to enter the system menu.
2. Press the up/down key or rotate the knob to select **Source->External programme** and press [Enter].
Set the External control state and control mode, press [Enter].

Remote Control

Through the analog input interface, the analog signal can be input to remotely set the output voltage value or power amplification function. For the detailed function definition of the pin, please refer to the definition of the analog pins description. The following is an example of amplitude modulation to introduce how to connect and how to use.

When the voltage setting is controlled through the analog interface, the external voltage (-10V ~ 10V) is connected to program the voltage value between 0 and full scale(AC mode).

For example, analog control AC range of 0~350V voltage, when the analog signal voltage is set to 5V, the voltage ratio set to 50V/1 under source menu, the instrument output voltage is set to $5 \times 50 = 250V$.

When parallel machine operation, can be controlled through the host analog interface.

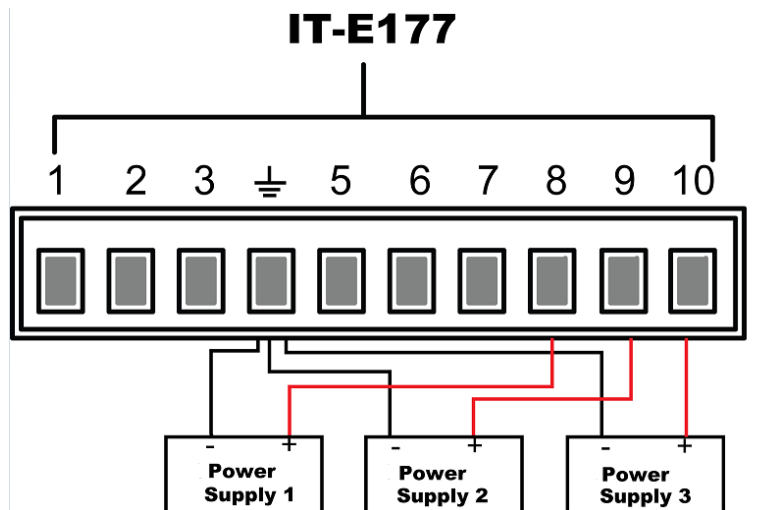

Power Amplification

Analog signals can be input through the analog input interface and power amplification function can be realized. The operation method is as follows:

Connecting the analog interface, different interface function are different, please refer to pins description as above.

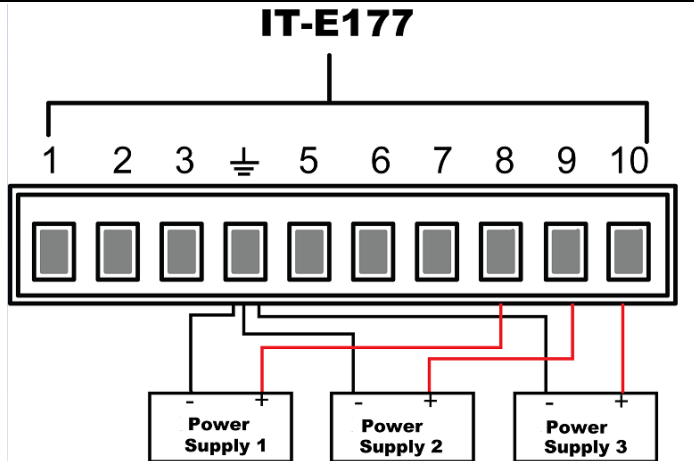

Voltage and current monitoring

Through the analog interface, the existing output voltage/current can be monitored. Connect a digital voltmeter or oscilloscope between pin 5 (V_Monitor), pin 6 (I_Monitor) and ground wire 4 (GND) of the analog interface. The -10V ~ 10V voltage reading corresponds to the power voltage and current output between negative full range and positive full scale (For AC, 0 to 10V corresponds to 0 to full scale).

For example, Monitoring AC range of 0~350V voltage, when the monitoring voltage is 5V, the voltage ratio set to 50V/1 under source menu, the input voltage is $5 \times 50 = 250V$. The wiring diagram is shown in the figure below.

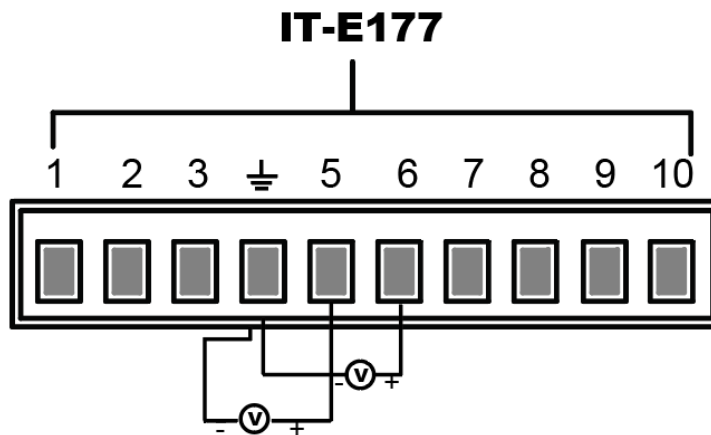

Chapter6 Measurement Functions

This chapter describes the characteristics and operations of the basic metering function of IT7800HV series source.

This series source has rich functions of basic metering of electric energy and can accurately measure the parameters such as Vrms, Irms, Ipeak, Idc, CF, PF.

6.1 Meter Mode



Press  on the front panel to enter the metering interface. The measurement interface is shown in the figure below.

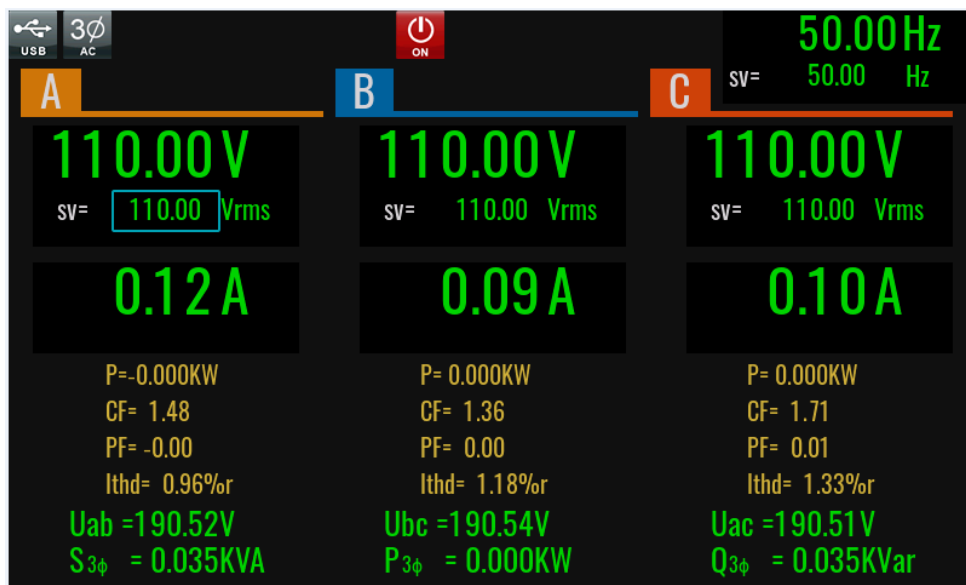

Description of the metering parameters:

Parameter	Description
A/B/C	Three phase indicator
Voltage Vrms	Setting voltage AC/ACDC mode: Vac setting value DC/DCAC mode: Vdc setting value
Frequency Hz	Setting frequency Only valid in AC/ACDC/DCAC mode.
P	Active power [W]
PF	Power factor
CF	Crest factor
Ithd	Current THD
Uab	Voltage of AB phase
Ubc	Voltage of BC phase
Uac	Voltage of AC phase
S	Apparent power
Q	Reactive power
Sa	Total three-phase apparent power
P _Σ	Total three phase Active power
PFa	PFa=P _{total} /S _{total}

6.2 Oscilloscope Mode

IT7800HV series source has the function of displaying the waveform based on sampling data. The user can select to display or hide the voltage and current waveform of the input unit. Only the necessary waveform is displayed, which can facilitate observation. The waveform display interface includes the vertical axis and horizontal axis.



Press  on the front panel and the following waveform display interface will appear. Different modes display different interfaces. the Oscilloscope interface is shown in the figure below.

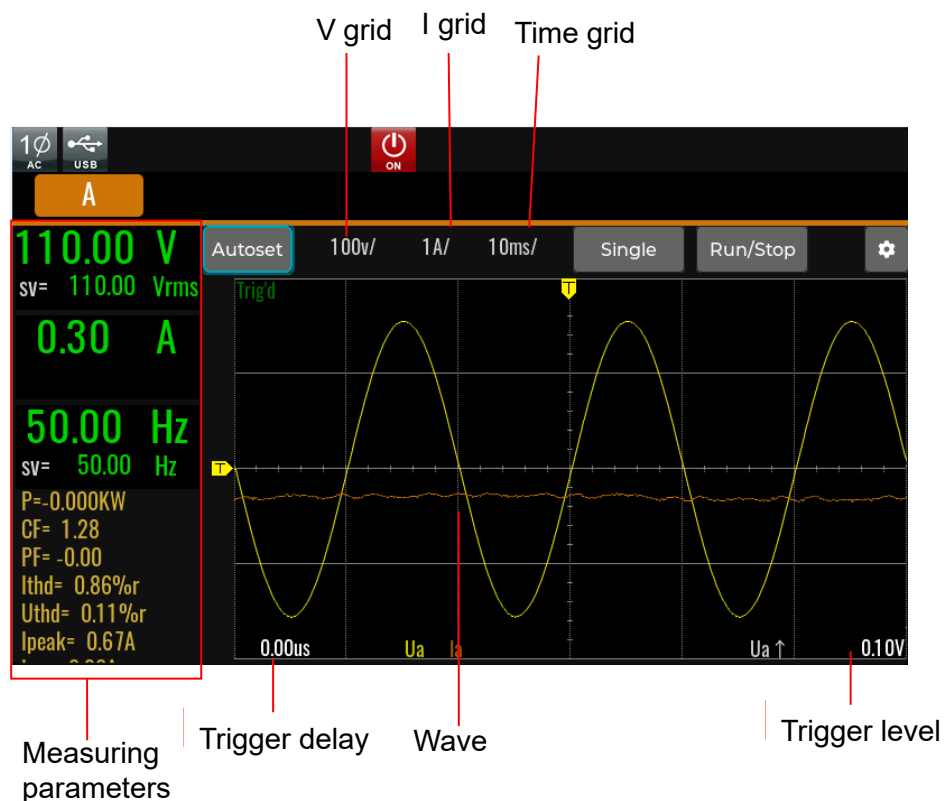

Description of keys on the waveform display interface:

Voltage/Current/Time: Adjust voltage/current/time base range

Single: Single measurement key: when single measurement is enabled in the Stop status, the stop status is enabled again after one measurement based on the current data updating rate. When single measurement is enabled in the Ready status, the instrument immediately restarts one measurement and then enters the Stop status.

Run/Stop: press the corresponding soft key to run or stop the waveform status.

AutoSet: Automatically adjusts the scale of the appropriate vertical axis.



: Advanced configuration options for oscilloscope function.

- Trigger source: Select trigger source, Voltage/Current and rise edge or fall edge can be select.
- Trigger mode: Auto and Normal can be select.
- Print data: save the data

- Line selection: Select the displayed curve, which is used to select whether to display the voltage/current waveform of the corresponding phase. Up to 6 oscillographic data curves can be displayed.

U† : Voltage trigger setting

Vertical calibration

The voltage range and current range are subject to vertical calibration (voltage/scale and current/scale). Press the soft key **[Function]** and select Volt-Range or Curr-Range. Rotate the knob to set the voltage or current range of each interval.

Horizontal calibration

If the soft key **[Function]** is pressed and “Trig-TimeBase” is selected, you can rotate the knob to adjust the horizontal scale (scanning speed). When the horizontal (time/scale) setting is changed by rotating the knob, you can observe the change of time/scale on the screen. During data collection, the sampling speed can be changed by adjusting the horizontal calibration knob. After collection is stopped, the collected data can be amplified by adjusting the horizontal calibration knob.

Trigger waveform

When the specified trigger conditions are satisfied, the trigger waveform will be displayed. The triggering time is the trigger point, generally on the right of the screen. When the trigger point is reached, the screen will display the waveform from left to right over time. The user should set the following parameters before using the trigger function.

- Trigger mode

The trigger mode refers to the condition to update the contents on the screen. It is divided into the Auto mode and Normal mode. In the Auto mode, the displayed waveform will be updated when triggering occurs in the suspension time; otherwise, the displayed waveform will be updated automatically.

In the Normal mode, the displayed waveform will be updated in the case of triggering and not updated in the case of no triggering.

- Trigger source

The trigger source is used for generating trigger conditions. The user can select the trigger source in the input signal of the input unit.

- Trigger slope

The slope refers to the change of the signal from low level to high level (rising edge) or from high level to low level (falling edge). The slope used as a trigger condition is referred to as the trigger slope.

- Trigger level

The trigger level refers to the level which the trigger slope passes through. If the signal of the trigger source passes through the set trigger level according to the specified trigger slope, triggering occurs. When the soft key **[Function]** is pressed and “Trig-Level” is selected, you can rotate the knob

to adjust the trigger level. In this case, the trigger level can be changed by rotating the knob and you can observe trigger level changes on the screen.

Print data

In the advanced menu, users can select the Print Data item and select the data logging mode. Data of oscilloscope interface will be recorded to U disk.

Print data mode:

- Off: turn off the print data function.
- Post: The recorded data is consistent with the data displayed on the oscilloscope interface
- Raw: The recorded data is original data
- Both: Post and Raw, record two data file

6.3 Harmonic measurement

IT7800HV series source can display harmonic parameters in the list or bar chart form to make the analysis of test result clear.

6.3.1 Harmonic measurement



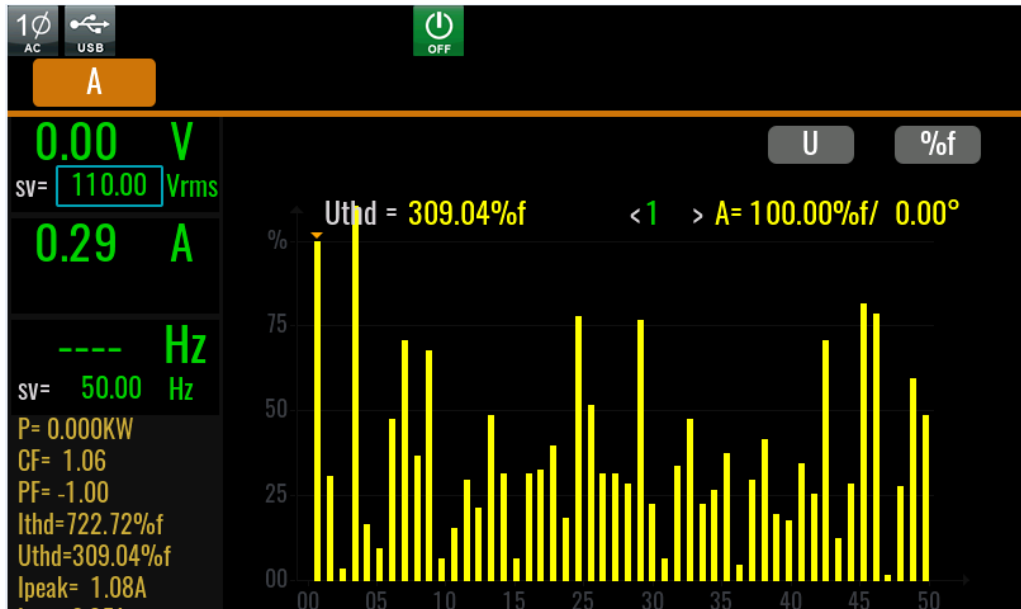

Press  key on the front panel, and the following initial interface of harmonic measurement will appear.

- Harmonic bar chart screen



Description of keys on the harmonic display interface:

 / : Select the voltage/current harmonic

: Distortion factor calculation formula.

%r: displaying harmonics in the form of percentage to the overall voltage amplitude of all harmonics.

%f: displaying harmonics in the form of percentage to the fundamental voltage.

THD: Under single phase mode, display total harmonic distortion of the single

phase. Under three-phase mode, display total harmonic distortion (THD) factors corresponding to Phase A, B and C.

Single harmonic parameters: Under single phase mode, display single harmonic distortion factor and phase of the single phase. Under three-phase mode, display the single harmonic distortion factor and corresponding phase. Rotate the knob to select the number.

- Harmonic list screen

When LIST mode is selected in the harmonic measurement mode, the list of harmonic measurement results will be displayed, when “U” is selected, the list will display the voltage and phase values under various harmonics. When “I” is selected, the current and phase values will be displayed. Under single-phase mode, the list only displays measurement results for Phase A, and displays 0 for the other two phases, as shown in the figure below; under three-phase mode, display effective values for the three phases.



Harmonic number list: the signal data of 0-50th harmonic(s) will be shown in the LIST. You can press the Up and Down key to display the hidden rows, i.e. hidden data of single harmonic data.

- Introduction to vector interface

When vector mode is selected in the harmonic measurement mode, to enter the vector measurement interface, as shown in the figure below.

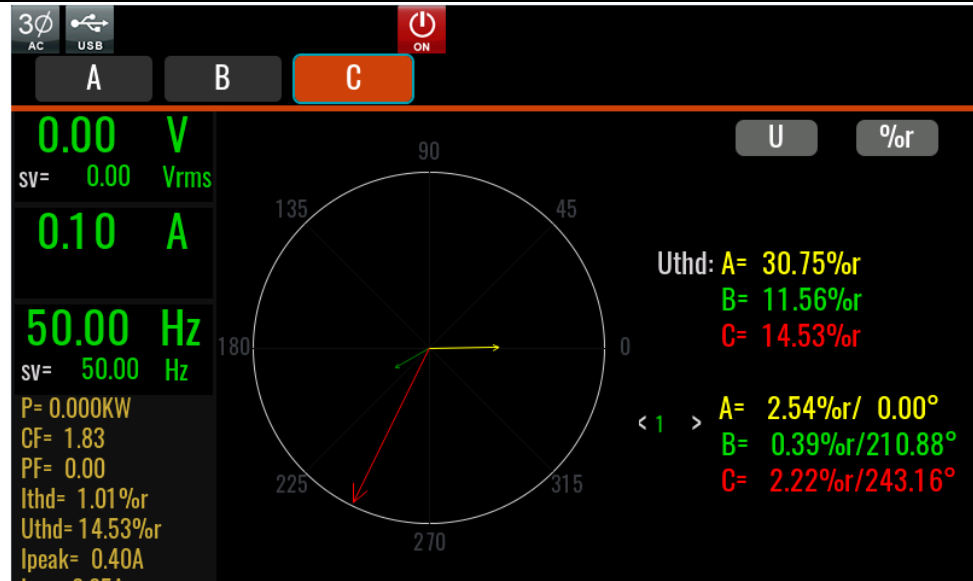

6.3.2 Harmonic Analysis (Coming soon)

This series of instruments can set the analysis conditions during harmonic measurement, filter the harmonic measurement data according to the set conditions, and mark the corresponding non-conformities in red. It is convenient for users to do harmonic test analysis. The set conditions can be THD value of voltage and current, THC, POHC, PWHC and IEC61000-3-2/IEC61000-3-12 regulation items.

THD observe				
Total THD observe setting				Enable
U-THD >=	I-THD >=	THC >=	POHC >=	PWHC >=
0.00 %or	0.00 %or	0.00 A	0.00 A	0.00 A
Category	IEC 61000-3-2	Subset	Class C	
Harmonic order h	Max Permissible lthd %			
2	2			
3	30*PF			
5	10			
7	7			

Item	Description
Total THD observe setting	THD interface observation switch, this setting is globally effective and takes precedence over each regulation module setting item. Enable: Harmonic analysis according to conditions Disable: Does not perform harmonic analysis
U-THD	Total harmonic distortion of voltage
I-THD	Total harmonic distortion of current

Item	Description
THC	total harmonic current (The total rms value of the harmonic current components of order 2 to 40)
POHC	Partial odd harmonic current
PWHC	Partial weighted harmonic current
Catagory	Category of Regulations
Subset (IEC61000-3-2)	Class A: Harmonic order h Max harmonic current I_h/I_{ref} Class B Harmonic order h Max harmonic current I_h/I_{ref} Class C Harmonic order h Max Permissible $I_{thd}\%$ Class D Harmonic order h Max Permissible I_{thd} per watt mA/W Max harmonic current I_h/I_{ref} Note: Parameter items are displayed only and cannot be edited
Subset (valid for Self-defined)	I THD U THD U/I THD 1. Form parameter items can be edited, 51 parameters can be edited 2. I THD or U THD title suffix %f/%r dynamically changes according to the harmonic interface configuration items 3. I THD/ U THD, The parameter value is set to -1 to delete the current edit line parameter 4. After editing the parameters, sort them dynamically from smallest to largest by harmonic order h settings
Type (IEC61000-3-1)	Phase type Non-balance 3-Phase Balance 3-Phase Balance 3-Phase(a,b,c) Balance 3-Phase(d,e,f) Note: Table parameter entries are displayed only and are not editable. I_{ref} : reference current, I_h : harmonic current component
Rise (IEC61000-3-12)	Minimum short-circuit ratio limit value

After setting, press Esc to return to the harmonic measurement interface, and the instrument measurement interface will display the results after harmonic analysis.

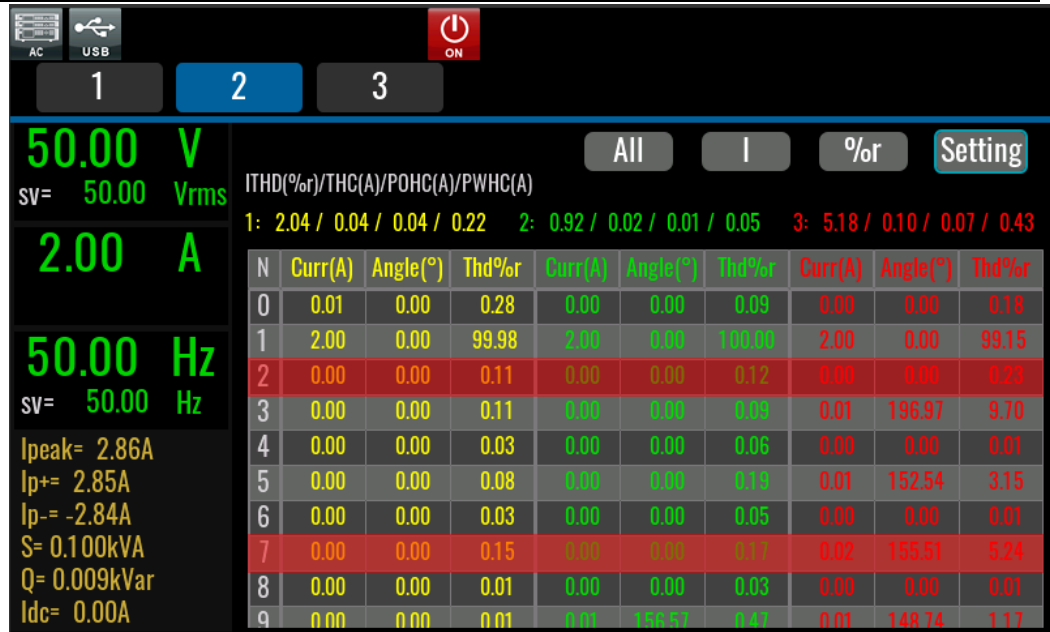

6.4 Recorder Function

The data recording function allows you to observe and record output status data for a long time. On the recorder interface, you can select a maximum of six data curves to be displayed. See the figure below.

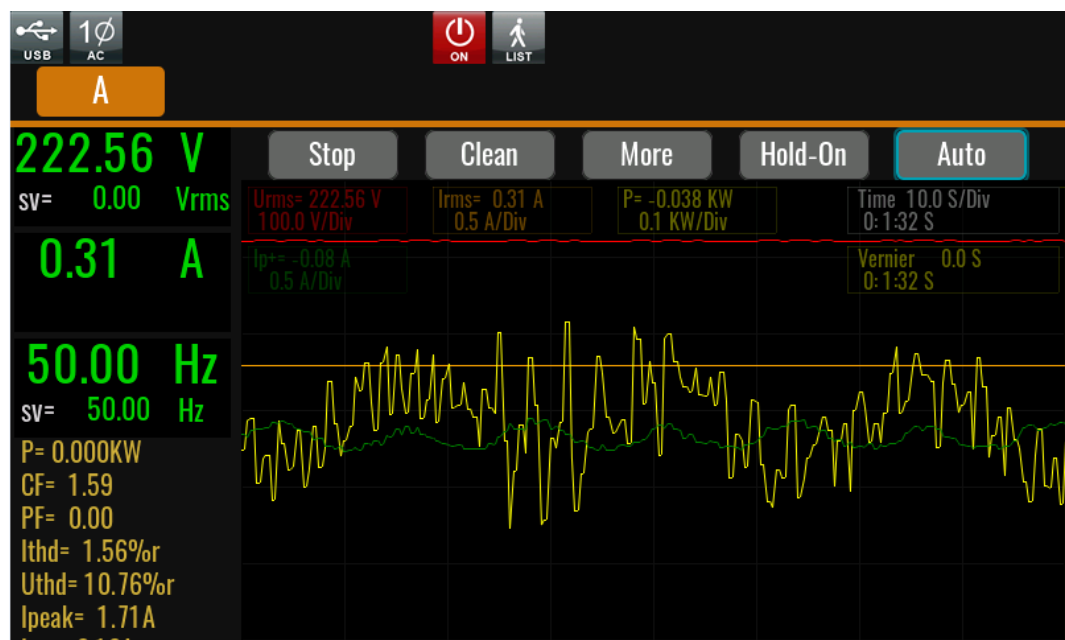

Run/Stop: Stop refresh data.

Clean: Clean all of data curve.

More: Enter to the advanced menu to set more parameters.

- Viewing control: Select the data curve, up to 6 curves can be select.
- Meter sample: Set the sampling interval.
- File format: select the file format, include Tdms and CSV.
- Export to udisk: exporting all of present data to U disk.

- U disk real-time storage: Record data in real time to a USB flash drive. (This option is displayed when a USB flash drive is inserted)

Hold-On/Hold-Off: Pause screen data refresh (for data observation)/ Start dynamically observing the data

Auto: Automatically adjusts the scale of the appropriate vertical axis.

Time: The time value of each of the horizontal coordinates, unit is s/Div

Vernier: Position information of the vernier caliper.

Chapter7 Configuration Arbitrary Waveform

This chapter will introduce configuration of arbitrary waveform of IT7800HV. Besides the five standard waveforms (see 4.3 Waveform Selection) built in the main interface, the user can enable the outputting of AC wave sequences of different amplitudes through List and self-define function.

The list function is not supported in multi-channel mode.

7.1 List Function

at maximum of 200 steps can be edited for each List file. The user can choose any waveform from existing 11 waveforms. Or, the user can choose a waveform file stored in the device through self-define function (see 7.3 “Self-defined Waveform Function” for details) and combine the waveform files into a List file based on required order. Meanwhile, the user can set the starting steps of the List file, run count and end state of the waveform, and edit parameters such as frequency, amplitude, running time and rising slope of each waveform.

The following description and screenshots take AC mode as an example. The parameters in other modes are different. The actual shown page shall be subject to the output mode.

7.1.1 Create a new List file

Create a new single-phase List file

Under single-phase mode, the user can output AC waveform sequences with different amplitudes by creating a new List file. Detailed operation steps are as below:

1. Press [Shift]+[V-set](list) on the front panel to enter the List function configuration interface, as shown in the figure below.

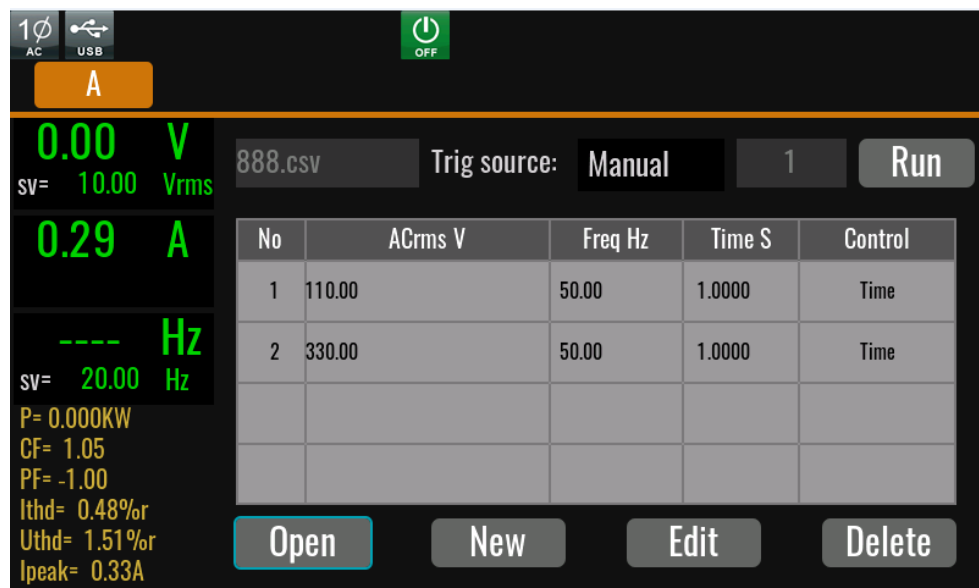

888.csv: the list file name to execute.

Trig source: select the trigger source

Run/Stop: Run/stop the list function.

Open: Select the List file to execute.

New: Create a new List file.

Edit: Edit present list file

Delete: delete the present List file.

2. Press **[New]** and enter to the List file edit interface.

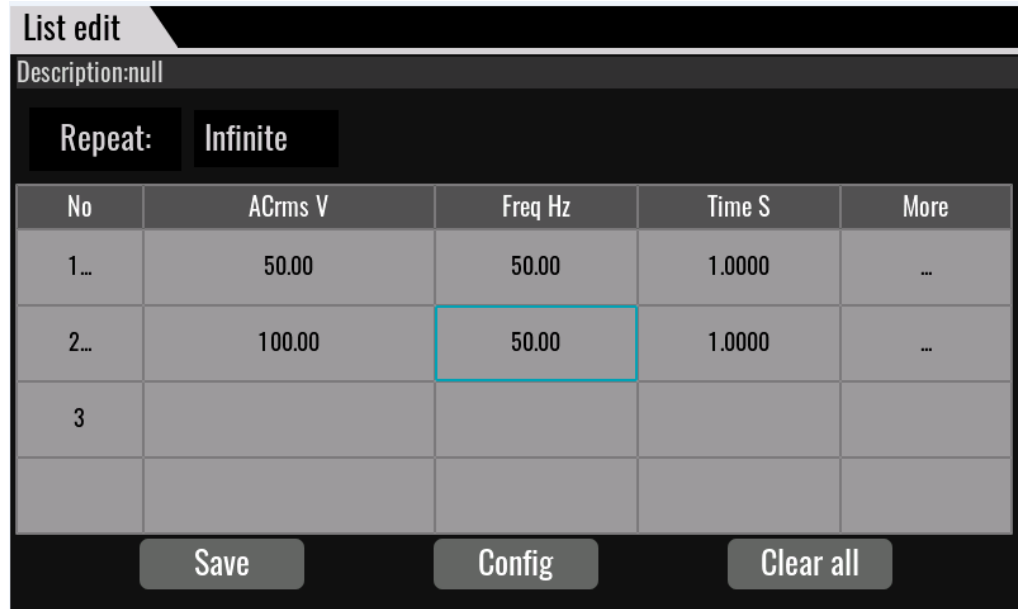

List edit

Description: null

Repeat: **Infinite**

No	ACrms V	Freq Hz	Time S	More
1...	50.00	50.00	1.0000	...
2...	100.00	50.00	1.0000	...
3				

Save Config Clear all

List edit description:

Description: Description of List, display list file name.

Repeat: The number of times the List file loops. You can choose Infinite and Count, when you choose count you also need to set the total number of loops, setting range: 1-999999

Jump: The number of the step to be skipped in the loop, for example, when set to 2, it runs normally for the first time, and the second and subsequent loops skip the previous two steps and start execution from step 3. The minimum value is 0, that is, no skipped steps all steps are looped.

End: Set the final waveform, with the following options available(Displayed when Count is selected for Repeat):

- Off: directly off the output after operation.
- Normal: return to normal after operation.
- Last: keep the last waveform output unchanged after operation.

No.: step number of list. Click the number, you can operate such as copy/paste/cut/insert/delete.

ACrms V: Voltage RMS value

Freq Hz: Frequency

Time S: width time, range from 0.0001s to 42949s

More: other settings, click ... and setup the slew rate, waveform, phase and so on.

Save: Save the list file to memory or to an external USB flash drive.

Config: configure the list file to make it effective.

Clear all: delete all of step information

3. Click (More)... enter to advanced menu of list file.

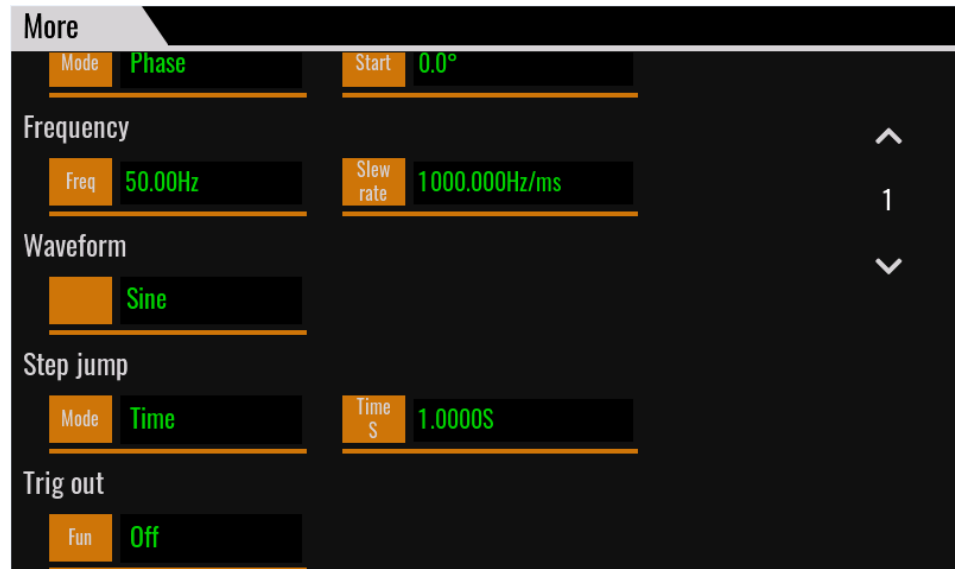

List parameters description:

Parameter	Description
Voltage AC	Voltage value and slope.
Start Phase	Start phase setting, displayed in AC mode. By default, the program automatically calculates this value (which is guaranteed to be continuous with the previous step). If the user modifies this parameter, the user set value is used without guarantee of continuity.
Phase Difference	Phase difference between ABC, only displays in AC 3-phase mode.
Frequency	Frequency and slope, displayed in AC mode.
Waveform	Waveform type, every basic waveform can be selected, displayed in AC mode.
Step jump	Method of step jumps to next step. Time: when the time is out, jumps to next step Trig: receive a trigger signal, jumps to next step. Phase: jumps to next step at this phase.
Trig out	Whether outputs a signal when this step is ending.

4. Press **[Esc]** to return Edit interface, Press **[Save]**.

At list Edit interface, click the step number, the **[Insert]/[Paste]/[Cut]/[Copy]** **/[Delete]** will display, click the key to edit.

5. Press **[Esc]** to return.

7.1.2 Open/Run List File

If several List files are edited, press Recall to recall the List file to be tested. Detailed operation steps are as below:

1. Press **[Shift]+[V-set](list)** on the front panel to enter the List function configuration interface.
2. Press **[Open]**, select the saved List01.csv file, and press **[Enter]** to enter the file.
3. Press **[On/Off]** on the front panel, turn on the output.
4. Press **[Run]** in the list function interface.
5. Running indicator will appear in interface.
Press scope key to view the output waveform.

7.1.3 Import/Export List file

Import List file

IT7800HV series support import list file function, The user can finish the editing of List file in Excel and import it into the software. This function simplifies the List file edit and facilitates user operation.

To help user define an Excel file format, please export a CSV template from the List interface.

Detailed operation steps are as below:

1. Create a new Excel document on local PC and name it List02.
2. Open the Excel document and save it as in “other formats” i.e. “(*.csv)”.
3. Open the List02.csv document and edit the List. Set every step of the List and corresponding parameters and save the document in the USB disk.

List import file formats under single-phase mode:

	A	B	C	D	E	F	G	H	I	J	K	L	M	N	O	P														
1	Model	IT7815-350-90																												
2	Firmware	000.000.223																												
3	Serial No.	S.04E*IT																												
4	Phase	mocl-Phase																												
5	File Type	List																												
6	Repeat	0																												
7	End State	Off																												
8	Total Cou	3																												
9	Trig Sour	Manual																												
10	Save Type	Local																												
11	No	A Vac	V	A Vac	sleA	Vdc	V	A Vdc	sleA	Wavefo	A	Start	p	Frequency	Frequency	Running	#Time	S	Trig	out	Step	mode	Trig	phas	End	phase	Trig	mode		
12	1	33	1000	0	1000	Sine	0	50	1000	Time	1	0	Continue	0	0	Inme														
13	2	22	1000	0	1000	Sine	0	50	1000	Time	1	0	Continue	0	0	Inme														
14	3	11	1000	0	1000	Sine	0	50	1000	Time	1	0	Continue	0	0	Inme														
15																														
16																														

4. Insert the USB disk into the USB interface of the front panel. Press **[Shift]+[V-set](list)** on the front panel to enter the List function configuration interface.
5. Press **[Open]**. Select the List02.csv file and open it. The List file will be imported.

Export List file

After editing the List file, the user can directly save it into the device or export and save it into the peripheral memory disc. The exported List is saved in the format of. (*.csv). Detailed operation steps are as below:

1. Insert the U disk into the USB interface of the front panel.
2. Press **[Shift]+[V-set](list)** on the front panel to enter the List function configuration interface.
3. Select **[Edit]**, enter to list file edit interface.
4. Press **[Save]**. This file will be exported into the USB disk.

7.2 Setting of Surge/Sag Configuration (Coming soon)

IT7800HV provides surge/sag simulation. The user can add surge/sag to simulate abnormal voltage fluctuation on the basic of outputting wave, and test usage of the DUT under this circumstance.

Surge/sag can be added to any waveform, the basic waveform is selected from the Config menu.



NOTE

When using the dimming function, this function will automatically turn off, and when using this function, dimming function is turned off.

Operating steps



1. Press **[Shift]+** (Surge&Sag) on the front panel to enter the List function configuration interface.



2. Set the voltage and frequency parameters in the sweep interface.

Parameters in the sweep interface are described as follows:

Parameter	Description
Mode	surge/sag executing mode. Trig: Trigger mode. Executing the surge/sag after receiving the trigger signal. Period: Period mode. Execute the surge/sag based on the period.
Action	This setting is valid when the mode select to Trigger. Immediately: Executing the surge/sag immediately. Phase: Executing the surge/sag at specific angle.
Trig source	Select the trigger source when the mode select to Trigger.
Start angle	Set the start phase angle of the surge/trap when the mode select to trigger.

Parameter	Description
Angle width	Set the period of the surge/trap. For example, start angle=30 degree, Angle width=30 degree, then, the waveform will execute surge/sag at 30 to 60 degree.
Symmetry	Whether to produce symmetrical surge/sag waves. If Start angle + Angle width >180°, this setting is Off state.
Repeat count	repeat count of surge/sag waves.
Repeat cycle	Number of cycles to generate surge/sag waves. This parameter is meaningful only in Period mode. This setting is used in combination with Repeat count, for example, if Repeat count is set to 5 and Repeat cycle is set to 10, five surge/sag waves occur in every 10 cycles.
Enable	Phase A/Phase B/Phase A&B/Phase B&C/Phase A&C/PhaseA&B&C: Select the phase information where the surge/notch occurs.(displays under 3-phase mode)
Enable	Synchronize: Each of the three phases executes surge/trap at the same time. Specify Phase: Each of the three phases executes surge/trap at the specified phase. (displays under 3-phase mode)
Value select	Value select: Percent: Set the percentage of the surge/trap amplitude to AC signal amplitude (RMS). Setting: Set the value of the surge/trap amplitude.

3. Press [On/Off] on the front panel and enable the output.
4. Press [Run] on the interface, Then the running status will be displayed on LCD. Output parameters and measurement parameters are displayed on the left side of the interface. You can also press the Meter to observe the output parameters in the main interface.
5. After execute, [On/Off] on the front panel will be off, and running status will be displayed on LCD. You can press [Stop] on the interface to stop the surge/sag function.

7.3 Self-defined Waveform Function

In AC mode or AC+DC mode, you can customize waveform curves and save them locally as output waveform options. This self-defined waveform can be used as a normal output waveform or as a wave option for scanning waveform, Surge/Sag waveform, and LIST waveform.

7.3.1 THD

The distorted waveform can simulate voltage harmonic wave in the circuit. The user can set the extent to which the output voltage waveform deviates from the Sin wave voltage and test the usage of the DUT under this circumstance.

THD includes built-in 30 waveforms and user - defined waveforms. The interface is shown below.

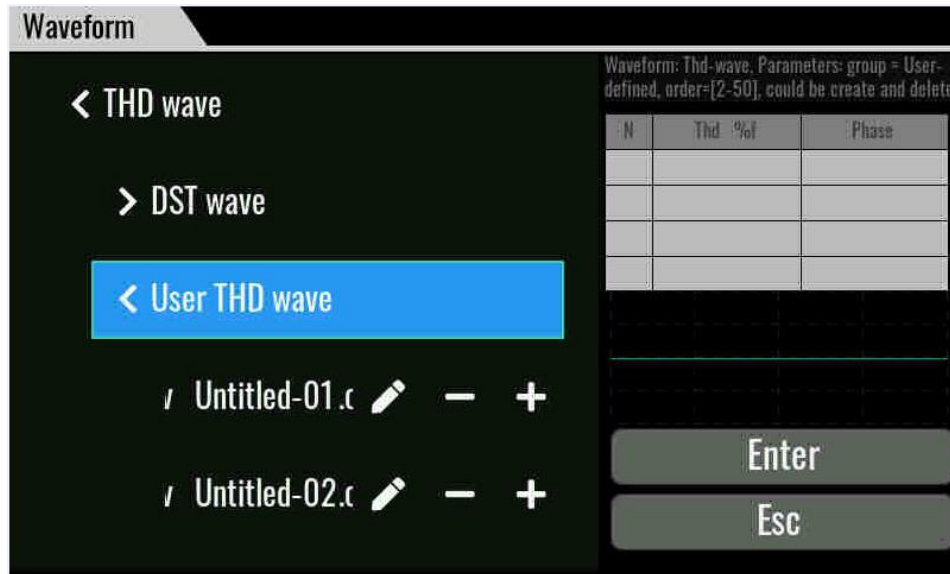

DST wave: Select waveforms which built into the instrument by default. When the waveform name is selected, the parameters and waveform diagram are displayed on the right side of the interface.

User THD wave: THD wave of user defined.

“+” Create a new THD wave.

“-“ Delete the seleted THD wave.

“” Edit the THD wave.

Press the “+” or “” enter to the edit interface.

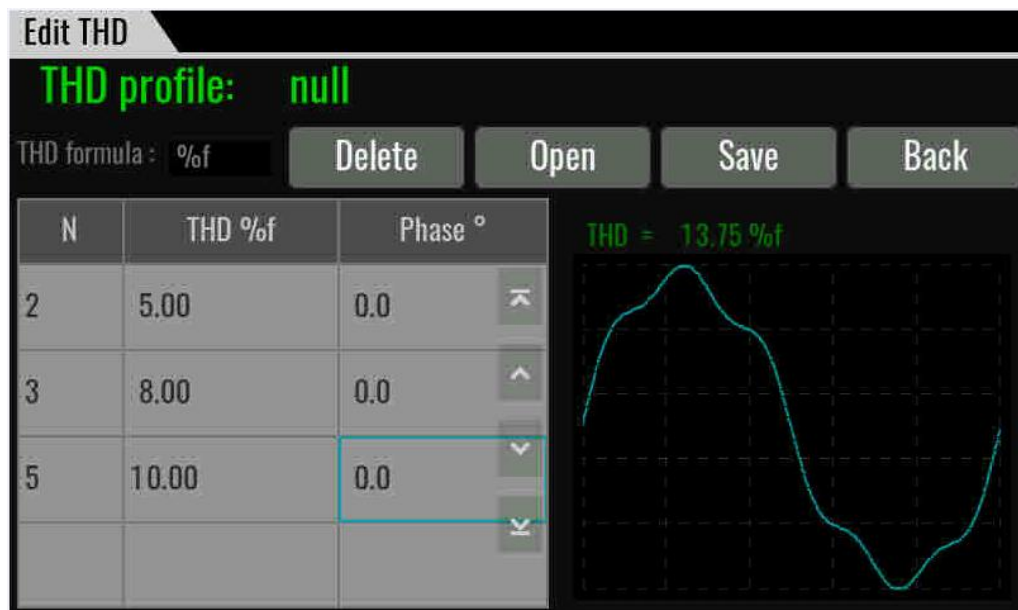

Thd profile: THD file name

Thd formula: Distortion factor calculation formula.

%r: displaying harmonics in the form of percentage to the overall voltage

amplitude of all harmonics.

%f: displaying harmonics in the form of percentage to the fundamental voltage.

THD phase: THD waveform fundamental phase angle, you can control the angle of the start of the waveform.

Delete: select a row and click Delete.

Open: import Thd wave data.

Save: Save the THD wave.

Back: return back upper menu.

THD=: Total distortion rate calculated based on the user Thd configuration.

Import THD file

A	B	C	D
Model	ITxxxx	Device_operation	0
Usage	Wave		
Name	Untitled-01.csv		
Type		8	
Editable		1	
Formula		0	
Unit_number		39	
Fund_phase		0	
Order	Thd	Phase	
	2	5	0
	3	9	180
	4	2	0

Users can edit a custom harmonic waveform file in .csv format and import it into the instrument. User defined harmonic waveform template files can be obtained by contacting ITECH, or an empty file can be exported directly from the instrument.

The harmonic waveform template description as follows:

Model: instrument model, Keep default.

Device_operation: operation mode of instrument, 0: voltage source, 1: load, 2: current source, Users are cautious to modify, the waveform files are not common in different modes.

Usage: Usage, keep default

Name: keep default

Type: Waveform type, harmonic custom waveform is 8, which must be 8 in this file.

Editable: keep default

Formula: Harmonic calculation formula, 0 represents f%, 1 represents r%

Unit_number: The number of data points edited needs to be consistent with the number of data rows.

Fund_phase: phase of fundamental waves, range from 0-360°

Order: harmonic order, range from 2-50

Thd: Thd value

Phase: phase of harmonic

7.3.2 User-defined waveform

“+” create a new wave.

“-” delete the wave file.

 edit the wave file.

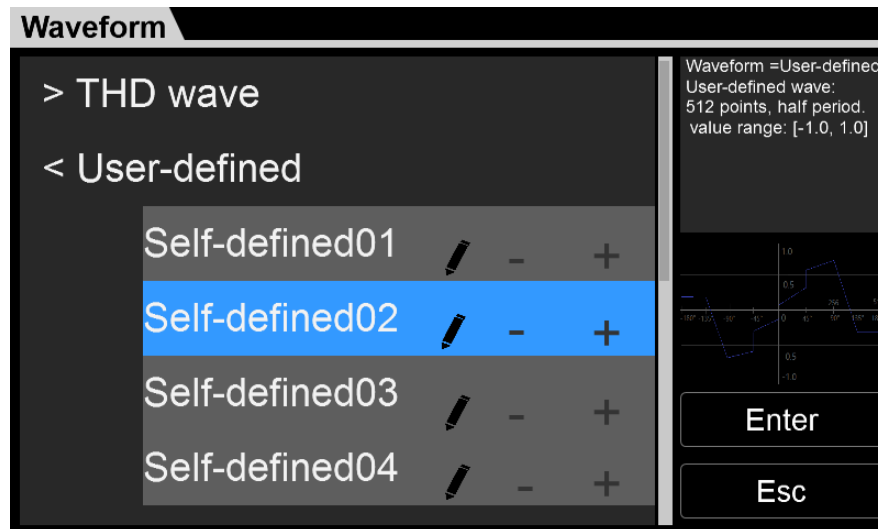

Edit interface:



Profile: user-defined file name

Origin Symmetry: To select the waveform data type, you can select 512 origin symm/512 origin asymm /1024 points

Open: import waveform data.

Save: Save the user-define wave.

Delete: select a row and click Delete.

Clean: delete all of data

Back: return back upper menu.

Import user-define waveform file

	A	B	C	D
Model	IT7800		Device_operation	0
Usage	Wave			
Name	Userdefine.csv			
Type		9		
Editable		1		
Point_number		1024		
Origin_symm		2		
index	fval			
	0	0		
	1	-0.0184		
	2	-0.0368		
	3	-0.0552		
	4	-0.0736		
	5	-0.0919		
	6	-0.1102		

Users can edit a user-defined waveform file in .csv format and import it into the instrument. User defined harmonic waveform template files can be obtained by contacting ITECH, or an empty file can be exported directly from the instrument.

The user-defined waveform template description as follows:

Model: keep default

operation mode of instrument, 0: voltage source, 1: load, 2: current source, Users are cautious to modify, the waveform files are not common in different modes.

Usage: Usage, keep default

Name: keep default

Type: Waveform type, user-defined waveform is 9, which must be 9 in this file.

Editable: keep default

Point_number: The number of data points to be edited, which needs to be consistent with the data row in the table. Associated with the Origin_symm parameter.

Origin_symm: symmetry option, 0 represents 512 non-origin symmetry, 1 represents 512 origin symmetry, 2 represents 1024 points.

Index/fval: Data points and detailed parameter values.

Chapter8 Technical Specifications

This chapter will introduce the main technical parameters of IT7800HV, such as rated voltage/current/power and so on. Besides, this part will introduce the working environment and storage temperature.

8.1 Supplemental characteristics

Recommended calibration frequency: once a year

Cooling style: fans

8.2 Main technical parameters

IT7890-700-90

Input parameters					
AC input	Wiring connection	3 phase 3wire + ground(PE)			
	Line voltage	RMS	(200~220) ±10% *1 (380~480) ±10%	V	
	Line current	RMS	< 360	A	
	Apparent power		< 121	kVA	
	Frequency		45~65	Hz	
	Power factor	typ	0.98		
Output parameters					
AC Output	Output voltage	V _{LN}	0~700	V	
		V _{LL}	0~1212	V	
	Output current	RMS (3phase)	90	A	
		Peak (3phase)	270	A	
	Output power	Max. Power (3phase)	90k	VA	
	Voltage setting				
	Range	3phase	0~700	V	
	Resolution		0.01	V	
	Accuracy		<0.1%+0.2% F.S.		
	Temperature coefficient		< 50ppm/°C F.S.		
	Current setting				
	Range	RMS	90	A	
	Resolution		0.01	A	
	Accuracy		<0.2% + 0.3% F.S.		
	Temperature coefficient		< 200ppm/°C F.S.		
	Frequency				
	Range		16~100	Hz	
	Resolution		0.01	Hz	
	Accuracy		0.01%		
	waveform synthesizer	50/60Hz	up to 50	orders	
	Phase				
	Range		0~360	°	
	Resolution		0.01	°	
Voltage stability	Line regulation		<0.05% F.S.		
	Load regulation *2		<0.1% + 0.1% F.S.		
	THD		< 1%		
	Voltage ripple	RMS	< 1.2	V	
	Dynamic	typ	200	us	

	response			
Voltage Slew Rate, Typical	≥2 V/μs with full-scale programmed voltage step			
Output Isolation	750Vac			
Measurement parameter				
Voltage RMS	Resolution		0.01	V
	Accuracy		<0.1%+0.2% F.S.	
	Temperature coefficient		< 50ppm/°C F.S.	
Current RMS	Resolution		0.01	A
	Accuracy		<0.2% + 0.3% F.S.	
	Temperature coefficient		< 200ppm/°C F.S.	
Output power	Resolution		0.001	kW
	Accuracy		<0.4% +0.6% F.S.	
Harmonic measurement	Max.	50/60Hz	up to 50	orders
Others				
Efficiency	typ	76%		
Protection		OVP, OCP, OPP, OTP, FAN, ECP, Sense		
Dimension		600.0000mm (W) *1475 (H) *841mm (D) (909mm(D) include protect cover)		
Weight		450kg		
Working temperature		0°C-50°C		
Programming response time		2ms		
Remote Sense Compensation Voltage		20V		
Communication interface		Built-in USB/CAN/LAN/Digital IO interface, optional GPIB / Analog&RS232		

*1 (200~220) ±10%, the power is 60% of the rated.

*2 The cabinet needs to be tested using the sense remote measurement mode.

All the above parameters are subject to change without prior notice from ITECH.

IT78180-700-180

Input parameters					
AC input	Wiring connection	3 phase 3wire + ground(PE)			
	Line voltage	RMS	(200~220) ±10% *1 (380~480) ±10%	V	
	Line current	RMS	< 720	A	
	Apparent power		< 242	kVA	
	Frequency		45~65	Hz	
	Power factor	typ	0.98		
Output parameters					
AC Output	Output voltage	V _{LN}	0~700	V	
		V _{LL}	0~1212	V	
	Output current	RMS (3phase)	180	A	
		Peak (3phase)	540	A	
	Output power	Max. Power (3phase)	180k	VA	
	Voltage setting				
	Range	3phase	0~700	V	
	Resolution		0.01	V	
	Accuracy		<0.1%+0.2% F.S.		
	Temperature coefficient		< 50ppm/°C F.S.		
	Current setting				
	Range	RMS	180	A	
	Resolution		0.1	A	
	Accuracy		<0.2% + 0.3% F.S.		

	Temperature coefficient		< 200ppm/°C F.S.	
	Frequency			
	Range		16~100	Hz
	Resolution		0.01	Hz
	Accuracy		0.01%	
	waveform synthesizer	50/60Hz	up to 50	orders
	Phase			
	Range		0~360	°
	Resolution		0.01	°
	Voltage stability	Line regulation		<0.05% F.S.
Load regulation *2			<0.1% + 0.1% F.S.	
THD			< 1%	
Voltage ripple		RMS	< 1.2	V
Dynamic response		typ	200	us
Voltage Slew Rate, Typical	≥2 V/μs with full-scale programmed voltage step			
Output Isolation	750Vac			
Measurement parameter				
Voltage RMS	Resolution		0.01	V
	Accuracy		<0.1%+0.2% F.S.	
	Temperature coefficient		< 50ppm/°C F.S.	
Current RMS	Resolution		0.1	A
	Accuracy		<0.2% + 0.3% F.S.	
	Temperature coefficient		< 200ppm/°C F.S.	
Output power	Resolution		0.1	kW
	Accuracy		<0.4% +0.6% F.S.	
Harmonic measurement	Max.	50/60Hz	up to 50	orders
Others				
Efficiency	typ	76%		
Protection	OVP, OCP, OPP, OTP, FAN, ECP, Sense			
Dimension	600.0000mm (W) *1475 (H) *841mm (D) (909mm include protect cover)*2			
Weight	450kg*2			
Working temperature	0°C-50°C			
Programming response time	2ms			
Remote Sense Compensation Voltage	20V			
Communication interface	Built-in USB/CAN/LAN/Digital IO interface, optional GPIB / Analog&RS232			

*1 (200~220) ±10%, the power is 60% of the rated.

*2 The cabinet needs to be tested using the sense remote measurement mode.

All the above parameters are subject to change without prior notice from ITECH.

IT78135-1050-90

Input parameters			
AC input	Wiring connection	3 phase 3wire + ground(PE)	
	Line voltage	RMS	(200~220) ±10% *1 (380~480) ±10%
	Line current	RMS	< 540
	Apparent power		< 181
	Frequency		45~65
	Power factor	typ	0.98

Output parameters					
AC Output	Output voltage	VLN	0~1050	V	
		VLL	0~1818	V	
	Output current	RMS (3phase)	90	A	
		Peak (3phase)	270	A	
	Output power	Max. Power (3phase)	135k	VA	
	Voltage setting				
	Range	3phase	0~1050	V	
	Resolution		0.1	V	
	Accuracy		<0.1%+0.2% F.S.		
	Temperature coefficient		< 50ppm/°C F.S.		
	Current setting				
	Range	RMS	90	A	
	Resolution		0.01	A	
	Accuracy		<0.2% + 0.3% F.S.		
	Temperature coefficient		< 200ppm/°C F.S.		
	Frequency				
	Range		16~100	Hz	
	Resolution		0.01	Hz	
	Accuracy		0.01%		
	waveform synthesis	50/60Hz	up to 50	orders	
Phase					
Range		0~360	°		
Resolution		0.01	°		
Voltage stability	Line regulation		<0.05% F.S.		
	^{*2} Load regulation		<0.1% + 0.1% F.S.		
	THD		<1%		
	Voltage ripple	RMS	< 1.8	V	
	Dynamic response	typ	200	us	
Voltage Slew Rate, Typical	≥2 V/μs with full-scale programmed voltage step				
Output Isolation	1100Vac				
Measurement parameter					
Voltage RMS	Resolution		0.1	V	
	Accuracy		<0.1%+0.2% F.S.		
	Temperature coefficient		< 50ppm/°C F.S.		
Current RMS	Resolution		0.01	A	
	Accuracy		<0.2% + 0.3% F.S.		
	Temperature coefficient		< 200ppm/°C F.S.		
Output power	Resolution		0.1	kW	
	Accuracy		<0.4% +0.6% F.S.		
Harmonic measurement	Max.	50/60Hz	up to 50	orders	
Others					
Efficiency	typ	76%			
Protection		OVP, OCP, OPP, OTP, FAN, ECP, Sense			
Working temperature		0°C-50°C			

Dimension		600.000mm (W) *1919 (H) *841mm (D) (909mm(D) include protect cover)
Weight		600kg
Programming response time		2ms
Remote Sense Compensation Voltage		20V
Communication interface		Built-in USB/CAN/LAN/Digital IO interface, optional GPIB / Analog&RS232

*1 (200~220) ±10%, the power is 60% of the rated.

*2 The cabinet needs to be tested using sense remote measurement mode.

All the above parameters are subject to change without prior notice from ITECH.

IT78270-1050-180

Input parameters					
AC input	Wiring connection	3 phase 3wire + ground(PE)			
	Line voltage	RMS	(200~220) ±10% *1 (380~480) ±10%	V	
	Line current	RMS	< 989	A	
	Apparent power		< 332	kVA	
	Frequency		45~65	Hz	
	Power factor	typ	0.98		
Output parameters					
AC Output	Output voltage	V _{LN}	0~1050	V	
		V _{LL}	0~1818	V	
	Output current	RMS (3phase)	180	A	
		Peak (3phase)	540	A	
	Output power	Max. Power (3phase)	270k	VA	
	Voltage setting				
	Range	3phase	0~1050	V	
	Resolution		0.1	V	
	Accuracy		<0.1%+0.2% F.S.		
	Temperature coefficient		< 50ppm/°C F.S.		
	Current setting				
	Range	RMS	180	A	
	Resolution		0.1	A	
	Accuracy		<0.2% + 0.3% F.S.		
	Temperature coefficient		< 200ppm/°C F.S.		
	Frequency				
	Range		16~100	Hz	
	Resolution		0.01	Hz	
	Accuracy		0.01%		
	waveform synthesis	50/60Hz	up to 50	orders	
	Phase				
	Range		0~360	°	
	Resolution		0.01	°	
Voltage stability	Line regulation		<0.05% F.S.		
	*2 Load regulation		<0.1% + 0.1% F.S.		
	THD		<1%		
	Voltage ripple	RMS	< 1.8	V	
	Dynamic response	typ	200	us	

Voltage Slew Rate, Typical	≥2 V/μs with full-scale programmed voltage step			
Output Isolation	1100V _a c			
Measurement parameter				
Voltage RMS	Resolution		0.1	V
	Accuracy		<0.1%+0.2% F.S.	
	Temperature coefficient		< 50ppm/°C F.S.	
Current RMS	Resolution		0.1	A
	Accuracy		<0.2% + 0.3% F.S.	
	Temperature coefficient		< 200ppm/°C F.S.	
Output power	Resolution		0.1	kW
	Accuracy		<0.4% +0.6% F.S.	
Harmonic measurement	Max.	50/60Hz	up to 50	orders
Others				
Efficiency	typ	83%		
Protection		OVP, OCP, OPP, OTP, FAN, ECP, Sense		
Working temperature		0°C-50°C		
Dimension		600.0000mm (W)*1919 (H)*841mm (D) (909mm include protect cover)*2		
Weight		600kg*2		
Programming response time		2ms		
Remote Sense Compensation Voltage		20V		
Communication interface		Built-in USB/CAN/LAN/Digital IO interface, optional GPIB / Analog&RS232		

*1 (200~220) ±10%, the power is 60% of the rated.

*2 The cabinet needs to be tested using sense remote measurement mode.

All the above parameters are subject to change without prior notice from ITECH.

Chapter9 Remote Control

This series power supply comes standard with four communication interfaces: USB, LAN and CAN, and supports two optional communication interfaces: GPIB, RS-232. You can choose one of them to communicate with your computer.



Note

When you use the remote interface to send SCPI instructions, if you use the programming commands that involve modifying the instrument settings, such as modifying the output voltage value, after completing the communication connection between the instrument and the host computer, and after the communication settings are completed, you must execute the **SYST:REM** command firstly.

9.1 USB Interface

Use cables with both USB ends to connect with IT7800HV and PC. All functions are programmable over the USB.

The USB488 interface capabilities are described below:

- The interface is 488.2 USB488 interface.
- The interface accepts REN_CONTROL, GO_TO_LOCAL, and LOCAL_LOCKOUT requests.
- The interface accepts MsgID = TRIGGER USBTMC command message and forwards TRIGGER requests to the function layer.

The USB488 device functions are described below:

- The device understands all mandatory SCPI commands.
- The device is SR1 capable.
- The device is RL1 capable.

The device is DT1 capable.

The operation steps to change the USB interface type in System Menu are as follows.

1. Press the composite keys **[Shift]+**  (System) on the front panel to enter the system menu.
2. Select Communication ->**USB** and press **[Enter]**.
3. Select **USB Type** to Device, and press **[Enter]**.
4. Select the USB device class to TMC or VCP.

9.2 LAN Interface

When the user connect PC through LAN interface, the following is required to use the LAN interface. The LAN interface complies with the LXI standard.

Connect Interface

Use the following steps to quickly connect your instrument to your LAN and configure it. Two typical LAN interface systems are described below: private LAN and site LAN.

- **Connect to the private LAN**

A private LAN is a network in which LAN-enabled instruments and computers are directly connected. They are typically small, with no centrally-managed resources. When connected to a computer, a standard network cable can be used to connect directly to the computer via the LAN interface.

- **Connect to the site LAN**

A site LAN is a local area network in which LAN-enabled instruments and computers are connected to the network through routers, hubs, and/or switches. They are typically large, centrally-managed networks with services such as DHCP and DNS servers. When connected to a computer, a network cable can be used to connect to the router, and the computer is also connected to the router.



Note

- When using one crossover cable to connect PC directly, the gateway address of the instrument should be consistent with that of the PC, and the IP address should be at the same network segment with the PC's IP address.
- When the instrument and computer are connected to the router, an independent IP address must be assigned for the instrument.

Configure LAN Interface Information

The configurable parameters of the IT7800HV series power supply are described as follows.

LAN Config:

- **Mode:** IP Address setting method, user can select automatically configure the address of the instrument (DHCP) or manually.
- **IP:** This value is the Internet Protocol (IP) address of the instrument. An IP address is required for all IP and TCP/IP communications with the instrument. An IP Address consists of 4 decimal numbers separated by periods. Each decimal number ranges from 0 through 255 with no leading zeros (for example, 169.254.2.20).
- **Mask:** This value is used to enable the instrument to determine if a client IP address is on the same local subnet. The same numbering notation applies as for the IP Address. When a client IP address is on a different subnet, all packets must be sent to the Default Gateway.
- **Gateway:** This value is the IP Address of the default gateway that allows the instrument to communicate with systems that are not on the local subnet, as determined by the subnet mask setting. The same numbering notation ap-

plies as for the IP Address. A value of 0.0.0.0 indicates that no default gateway is defined.

- **Socket Port:** This value indicates the port number corresponding to the service.

How to Configure

Take manual configuration as an example. The steps are as follows:

1. Press the composite keys [Shift]+  (System) on the front panel to enter the system menu.
2. Select **Communication** and press [Enter].
3. Press the Left/Right key to select **LAN** and set the mode to **Manual**.
4. Set the **IP**, **Mask** and the other parameters in turns, and press [Enter].

Using Web Server

The instrument has a built-in Web server for monitoring and controlling the instrument via a Web browser in PC. To use the Web server, connect the instrument and PC over LAN interface and enter the instrument's IP address into the address bar at the top of your PC's Web browser, you can access the front panel control functions including the LAN configuration parameters.

The format of the address entered in the address bar of the browser is **http://192.168.200.100**. The specific IP address is subject to the actual instrument settings.

The opened page is displayed as follows:

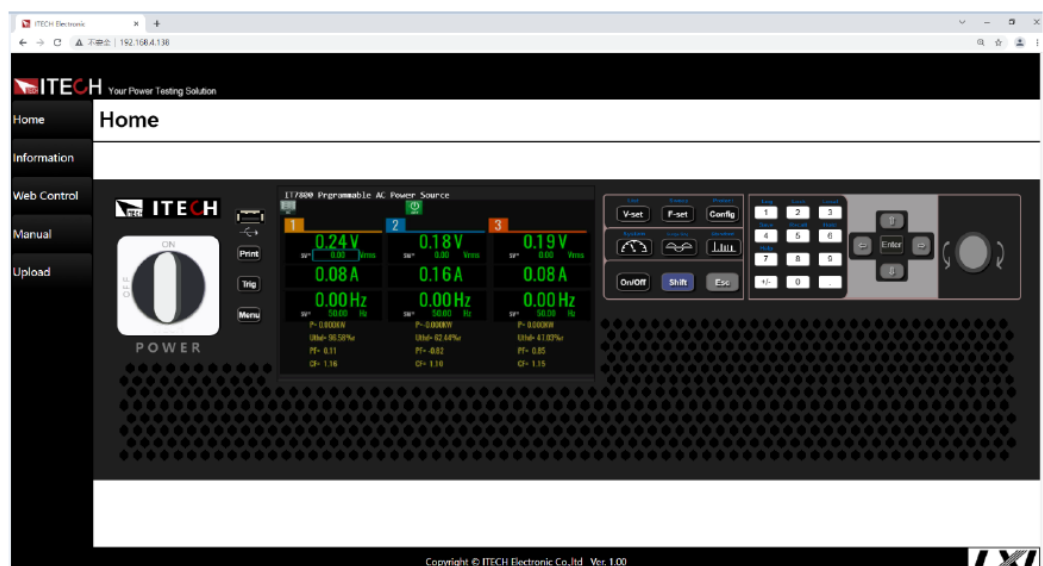

You can select different pages by clicking the buttons shown in the navigation bar on the left side of the window. The detailed descriptions are as follows.

- **Home :** Web home interface, displays the model and appearance of the instrument;
- **Information:** Displays the serial number of the instrument and more system

information as well as LAN configuration parameters;

- Web Control: Enables the Web control to begin controlling the instrument. This page allows you to monitor and control the instrument;
- LAN Configuration: Reconfigure the LAN parameters;
- Manual: Go to the ITECH official website and view or download the relevant documents.
- Upload: Performs a system upgrade.
- Click **CONNECT** to connect the PC with the instrument, then click
- **Select File** to select the system upgrade installation package (for example, IT7900P-U-V000.001.029all.itech), and then click **UPLOAD** performs the upgrade operation. After the upgrade is complete, the instrument needs to be restarted.

9.3 CAN Interface

The CAN interface is located on the rear panel of the instrument and is connected to the computer using a CAN communication cable.

Definition of CAN Pins

The definition of CAN pins are as follows.

Pins	Description
H	CAN_H
L	CAN_L

CAN Configuration

The user needs to configure the CAN interface parameters in the system menu before using the remote control. The CAN interface parameters are as follows.

Name	Description
Address	Range: 0 – 127
Baud rate	Select the baud rate from the following options: 5k/10k/20k/40k/50k/80k/100k/125k/200k/250k/400k /500k/600k/800k/1000k

The operation steps are as follows.

1. Press the composite keys [Shift]+  (System) on the front panel to enter the system menu.
2. Select **Communication** and press **[Enter]**.
3. Select **CAN** and press **[Enter]**.
4. Set the baud rate and address, press **[Enter]**.

CAN Troubleshooting

If you meet some problems when communicating with PC by CAN interface, please check the following items:

- PC and the instrument must have the same baud rate.
- Ensure you have used the correct communication cable (CAN_H, CAN_L). Please pay attention that some cable may not have a correct internal wiring even it is with an appropriate plug.
- The interface cable is correctly connected (CAN_H to CAN_H, CAN_L to CAN_L).
- If the communication signal is poor or unstable, it is recommended to connect a 120 Ω terminating resistance.

– The connection diagram of a single device is as below.

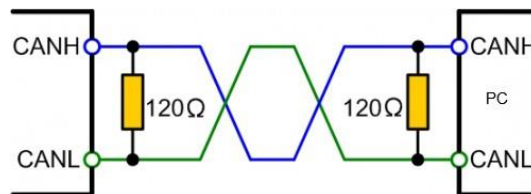

– The connection diagram of multiple devices is as below.

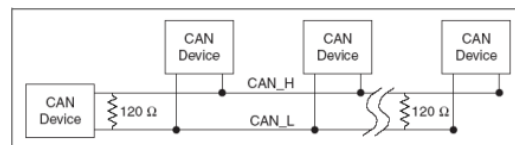

Note

When multiple devices are connected, it is recommended to connect the pin 8 (GND) of the P-IO terminal on the rear panel of these devices in parallel, and the communication quality will be improved in the entire CAN network.

9.4 GPIB Interface (Optional)

The GPIB (IEEE-488) interface is assembled in the IT-E176 communication board. Use a GPIB cable to connect GPIB interfaces of the instrument and PC. Please ensure that the screws have been screwed down in order to have a full connection.

GPIB Configuration

Each device on the GPIB (IEEE-488) interface must have a unique whole number address between 1 and 30. Your computer's GPIB interface card address must not conflict with any instrument on the interface bus. This setting is nonvolatile; it will not be changed by *RST.

When you purchase the interface accessory and successfully insert it into

the corresponding position on the rear panel of the instrument, the menu item for changing the GPIB address appears in the System menu. The specific steps are as follows:

1. Ensure that the instrument's power switch is off, that is, the instrument is in Power Off state.
2. Insert the separately purchased GPIB interface card into the card slot on the rear panel of the instrument.
3. Connect the instrument with the computer via the GPIB cable. After the connection is successful, turn on the power switch of the instrument.



4. Press the composite keys [Shift]+ (System) on the front panel to enter the system menu.
5. Select **Communication** and press [Enter].
6. Select **GPIB** and press [Enter].
7. Press the numeric keys to set the GPIB address and press [Enter].

9.5 RS-232 Interface (Optional)

The RS-232 interface shares the same communication card (IT-E177) with the analog function.

Definition of RS-232 Pins

The definition of RS-232 pins are as follows.

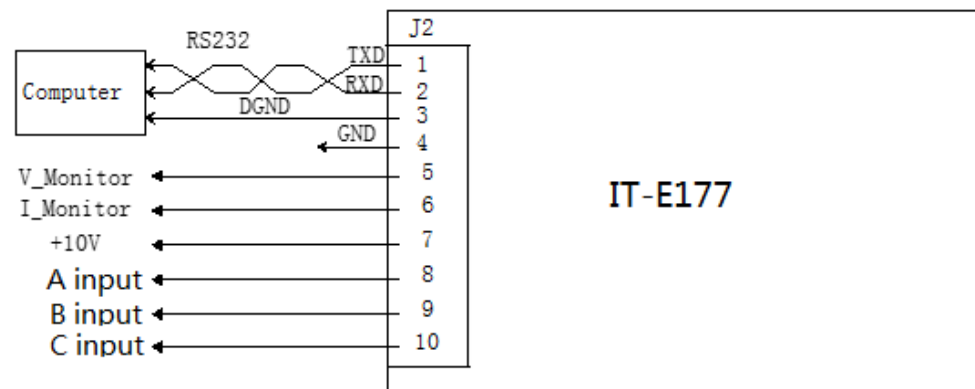

When using the RS-232 interface for communication, connect the pin 1, pin 2, and pin 3 of the IT-E177 to the PC. The pin description is as follows:

Pins	Description
1	TXD, transmit data
2	RXD, receive data
3	DGND, ground

RS-232 Configuration

When you purchase the interface accessory and successfully insert it into the corresponding position on the rear panel of the instrument, the RS-232 menu item will appear in the System menu. The specific steps are as follows:

1. Ensure that the instrument's power switch is off, that is, the instrument is in Power Off state.
2. Insert the separately purchased RS-232 interface card into the card slot on the rear panel of the instrument.
3. Connect the instrument to the computer via an RS-232 cable. After the connection is successful, turn on the power switch of the instrument.
4. Press the composite keys [Shift]+  (System) on the front panel to enter the system menu.
5. Select **Communication** and press **[Enter]**.
6. Select **RS232** and press **[Enter]**.
7. Set the relevant communication parameters in turn, and press **[Enter]**.

RS-232 Troubleshooting

If you meet some problems when communicating with PC by RS-232 interface, please check the following items:

- Check that whether the baud rate of the computer and instrument are the same;
- Make sure the correct cable and adapter are connected. Note that internal wiring may not be correct even if the cable has a suitable plug;
- The cable must be connected to the correct serial ports (COM1, COM2, etc) of PC.

9.6 Commonly Used Commands Overview

The IT7800HV series AC/DC power supply can be connected with the remote control device through the communication interface to realize the remote operation instrument by sending SCPI commands. This series of power supplies provides a detailed commands reference IT7800HV Programming Guide.

Listed below are common commands for users to quickly implement common operations. For more command information, refer to the corresponding commands reference.

```
-> SYSTem:REMOte           // set the instrument to the remote control mode
```

```
-> *IDN? //Query identification of instrument
-> SYSTem:FUNCTion ONE //Set the power mode to 1-phase mode
-> FUNCTion AC //Set the output mode to AC mode
-> VOLTage 220 //Set the voltage RMS to 220V
-> FREQuency 60.0 //Set the frequency to 60Hz
-> CURRent:PROTection:RMS 90 //Set the current RMS protect value to 90A
-> CURRent:PROTection:PEAK 270 //Set the current Peak protect value to 270A
-> OUTPut ON //Turn on/off the output
-> MEASure:VOLTage? //Measure the output Vrms
-> MEASure:CURRent? // Measure the output Irms
-> MEASure:POWer? // Measure the output power
-> SYSTem:ERRor? //Query the error information of the instrument
-> SYSTem:CLEar // To clear the error queue
-> OUTPut:PROTection:CLEar //To clear the protection status
```

9.7 Demo Software Introduction

IT7800HV series AC/DC power supply provides the following computer control software, convenient for users to achieve different test control. The standard version of the software can be downloaded from the official website, and the optional version of the software needs to be purchased separately.

- PV7800 Pro Demo Software (Standard)

IT7800HV series power supply supporting remote control software, users can directly download from the official website and install to the PC, to achieve remote control equipment by visualization method, IT9000-PV7800 software can achieve all the instrument panel operation. And the interface is simple and convenient to operate. For detailed introduction, please refer to PV7800 Pro Software Manual.

Appendix

Specifications of Red and Black Test Lines

ITECH provides you with optional red and black test lines, the user can choose the company's test line for testing. For specifications of ITECH test lines and maximum current values, refer to the table below.

Model	Specifications	Length	Description
IT-E30110-AB	10A	1m	Alligator clips-Banana plugs A pair of red and black test line
IT-E30110-BB	10A	1m	Banana plugs - Banana plugs A pair of red and black test line
IT-E30110-BY	10A	1m	Banana plugs - Y-type terminals A pair of red and black test line
IT-E30312-YY	30A	1.2m	Y-type terminals - A pair of red and black test line
IT-E30320-YY	30A	2m	Y-type terminals - A pair of red and black test line
IT-E30615-OO	60A	1.5m	Ring terminals - A pair of red and black test line
IT-E31220-OO	120A	2m	Ring terminals - A pair of red and black test line
IT-E32410-OO	240A	1m	Ring terminals - A pair of red and black test line
IT-E32420-OO	240A	2m	Ring terminals - A pair of red and black test line
IT-E33620-OO	360A	2m	Ring terminals - A pair of red and black test line

For maximum current of AWG copper wire, refer to table below.

AWG	10	12	14	16	18	20	22	24	26	28
The Maximum current value(A)	40	25	20	13	10	7	5	3.5	2.5	1.7

Note: AWG (American Wire Gauge), it means X wire (marked on the wire). The table above lists current capacity of single wire at working temperature of 30°C. For reference only.



Connect with us

Thank you for purchasing ITECH products. Any questions, pls. feel free to let us know.



You can chat with us on ITECH website



For more information, pls. visit www.itechate.com



Click and follow ITECH Electronics

