

IT7900EP High Performance Regenerative Grid Simulator

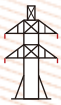

E-mobility



Grid



Energy
Storage



Photovoltaic



IEC Testing



Your Power Testing Solution

IT7900EP High Performance Regenerative Grid Simulator



Adopting advanced SiC technology, the IT7900EP series high-performance Regenerative grid simulator provides an all-in-one test solution that can be used not only as a grid simulator and four-quadrant power amplifier, but also as a four-quadrant regenerative AC/DC electronic load. The full four-quadrant operation, regenerative ability can feedback power to the grid, meet the needs of environmental protection, but also save a lot of electricity and heat dissipation costs. Compact, modular and efficient structure design allows the IT7900EP up to 21kVA in 3U single unit, and its power can be extended to 1MVA after master-slave parallel connection. Colorful touch screen with intuitive GUI allows IT7900EP to directly define different waveforms. The rich operation modes can meet the test requirement of single-phase, three-phase, reversed phase(split phase) . It provides high flexibility for testing and can be widely used in many fields such as PV, ESS and EV.



ESS

PCS energy storage converters, microgrids, home PV energy storage devices



PV

PV inverter, grid power system



EV

V2G, V2X, EVSE, vehicle type converters, electric vehicle power supply



Power Electronics

Uninterruptible Power Supply System (UPS), AC power supply, inverter Generators, transformers, AC fans



Electronic Components

Circuit breakers, fuses, connectors



Scientific research, universities, laboratories, certification bodies

AC-DC power adapter testing, electromagnetic compatibility testing

Model	Output voltage Vac		Output current Aac		Output power Pac	Phase	Height
	V L-N	V L-L	Arms(1Φ)	Arms(3Φ)			
IT7921EP-350-105	350V	606V	105A	35A	21kVA	1Φ,3Φ,reversed phase	3U
IT7942EP-350-210	350V	606V	210A	70A	42kVA	1Φ,3Φ,reversed phase	6U
IT7963EP-350-315	350V	606V	315A	105A	63kVA	1Φ,3Φ,reversed phase	15U
IT7984EP-350-420	350V	606V	420A	140A	84kVA	1Φ,3Φ,reversed phase	27U
IT79105EP-350-525	350V	606V	525A	175A	105kVA	1Φ,3Φ,reversed phase	27U
IT79126EP-350-630	350V	606V	630A	210A	126kVA	1Φ,3Φ,reversed phase	27U
IT79147EP-350-735	350V	606V	735A	245A	147kVA	1Φ,3Φ,reversed phase	27U
IT79168EP-350-840	350V	606V	840A	280A	168kVA	1Φ,3Φ,reversed phase	37U
IT79189EP-350-945	350V	606V	945A	315A	189kVA	1Φ,3Φ,reversed phase	37U
IT79210EP-350-1050	350V	606V	1050A	350A	210kVA	1Φ,3Φ,reversed phase	37U
IT79231EP-350-1155	350V	606V	1155A	385A	231kVA	1Φ,3Φ,reversed phase	37U

*Please contact ITECH for higher power needs.

*The above specifications are subject to update without notice.

Parameter Features

- Adopt advanced SiC technology
- High power density, up to 21 kVA for 3U
- Voltage can reach 350V L-N
- Highly efficient power regeneration
- Master and slave equal flow, parallel machines up to 1MVA
- Comprehensive working modes selectable: single-phase, three-phase, reversed phase(split phase) , Voltage extension to 200% of rated voltage in reversed mode
- Support LIST/SWEEP/Surge&Sag three waveform modes
- Built-in rich waveform database
- Harmonic simulation and analysis function up to 50 times,built-in IEC61000-3-2/3-12*1
- Can simulate arbitrary waveform output, support CSV file import waveform
- Phase angle 0-360° settable
- Touch screen design, simple UI interface
- Built-in USB/CAN/LAN /Digital IO interface,optional GPIB/analog & RS232 interface
- Full protection functions including automatic clearing,POVP ,watchdog, etc.
- Support CANopen*2、 Modbus、 LXI、 SCPI communication

Source Features

- Regenerative grid simulator & full 4-Quadrant AC&DC power sources
- Frequency: 16~2400Hz
- Power Amplifier function for PHIL applications
- Four output modes of AC/DC/AC+DC/DC+AC can be realized
- Programmable output impedance,simulation of real-world impedance
- Harmonic/inter harmonic synthesis
- Compliance tests incl. LVRT /Phase Jump/Frequency variation/ harmonic injection
- Supported regulatory testing include IEC61000-4-11/4-13/4-14/4-17/4-28/4-29

Load Features

- Regenerative full 4-Quadrant AC&DC load
- Frequency: 16-500 Hz
- AC mode supports CC/CP/CR/CS/CC+CR/CE multiple operating modes, and CE mode can simulate a variety of circuit topologies such as single-phase rectifier RLC and shunt RLC.
- DC mode supports 9 working modes such as CC/CR/CP/CV
- AC mode supports both rectified and non-rectified modes
- Adjustable crest factor: 1.414 ~ 5.0
- Support phase shift function in the range of -180°~180° *4
- The unit power factor1 function allows the current waveform to vary with the voltage waveform and the power factor is as close to 1 as possible
- Supporting unloading angle control, 0-359° adjustable

*1.Voltage/current harmonic analysis, voltage harmonic simulation in source mode, current harmonic simulation in load mode, fundamental wave≤60Hz

*2.Stay tuned

*3 After turning on the rectification function, the setting range of the phase shift is restricted by the crest factor



01

All in one unit

IT7900EP series integrates 3 products, a grid simulator, an AC/DC programmable power supply and a regenerative AC/DC load.

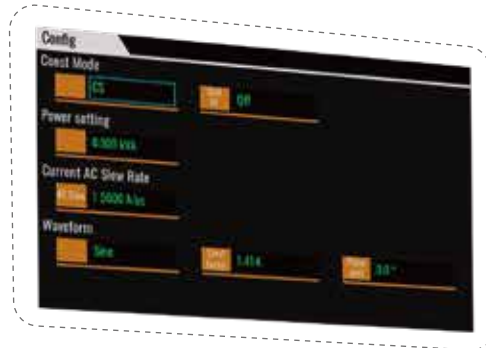

02

High power regeneration efficiency

Whether it is used as a grid simulator or a load, in AC or DC mode, the IT7900EP is high efficiently power regenerative. The energy generated by the DUT can be fed back to the local grid instead of dissipating in the form of heat, which is good for energy-saving and environment protection.

03

High power density

The IT7900EP series can provide 21kVA power output under 3U, and the voltage output can also reach 350V, the size is only 1/12 of the ordinary AC power supply on the market, which can be placed on your test bench, largely saves the space.



04

Various test items

Sliding the touch screen of the IT7900EP series is as simple as operating a mobile phone. The intuitive GUI not only allows multiple parameters displayed at the same time, but also multiple display ways are selectable, such as waveform graph, histogram, vector diagram and list.

05

Multiple protection and communication interfaces

IT7900EP series has a variety of protection functions to ensure the safety of the test, including: over-current Rms protection, over current peak protection, over temperature protection, automatic clear protection, software watchdog and so on. IT7900EP not only has built-in USB/CAN/LAN/digital IO interfaces, but also provides optional GPIB/analog & RS232.

06

Power extension by master-slave parallel connection

Through the master-slave parallel connection, the power of IT7900P can be extended up to 1MVA. It can be easily paralleled without disassembling and assembling the cabinet, and the multi-modules can synchronously share the current output. Not only will it retain all functions after paralleling, but there will be no precision sacrifice.

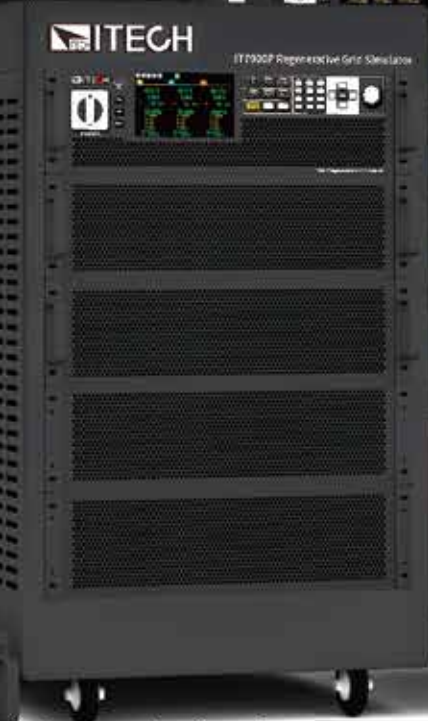

Outstanding Features

4-Quadrant output

IT7900EP series is not only a full four-quadrant power grid simulator, but also a full four-quadrant AC/DC electronic load. It can operate in all four quadrants. The efficient energy regeneration function makes it good for testing the frequency change of grid-connected PV inverters, voltage transients and anti-islanding protection.

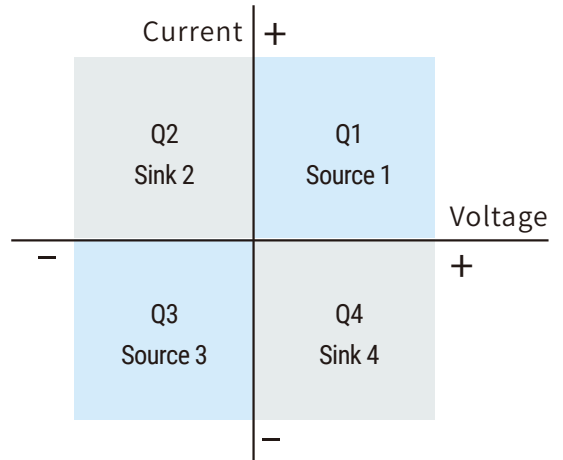

Full 4-Quadrant Power Amplifier

The IT7900P series regenerative grid simulator can be used as a power amplifier to complete power hardware in the loop (PHIL) applications for microgrids, energy storage and new energy vehicles. The digital I/O or a standard suite of analog signal can be input via an external analog interface (optional) and then amplified without distortion to a real power waveshape with an external analog response time of less than 100us.

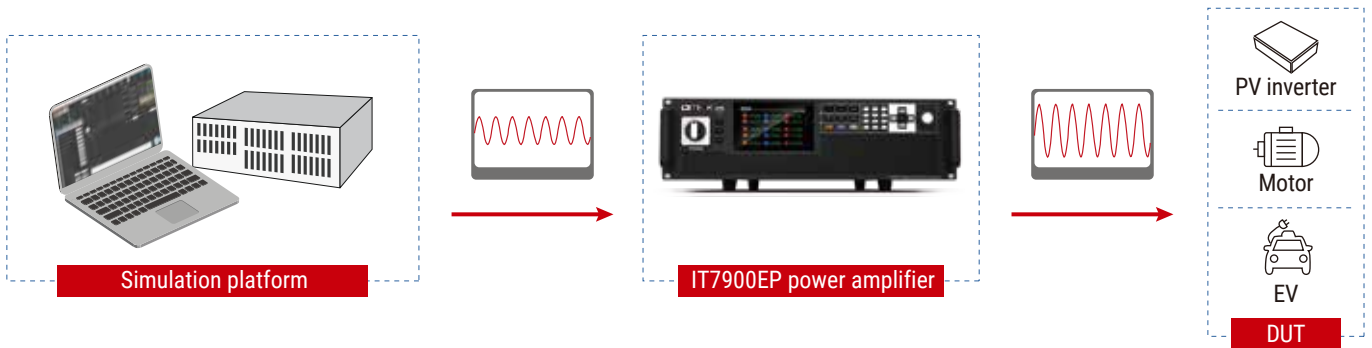

Pre-compliance regulation test

According to industry standards, IT7900P series has built-in regulation standards such as IEC61000-4-11/4-13/4-14/4-17/4-28/4-29, IEC61000-3-2/3-12. These regulations can be recalled directly. You can also customize the test items required by regulations too.

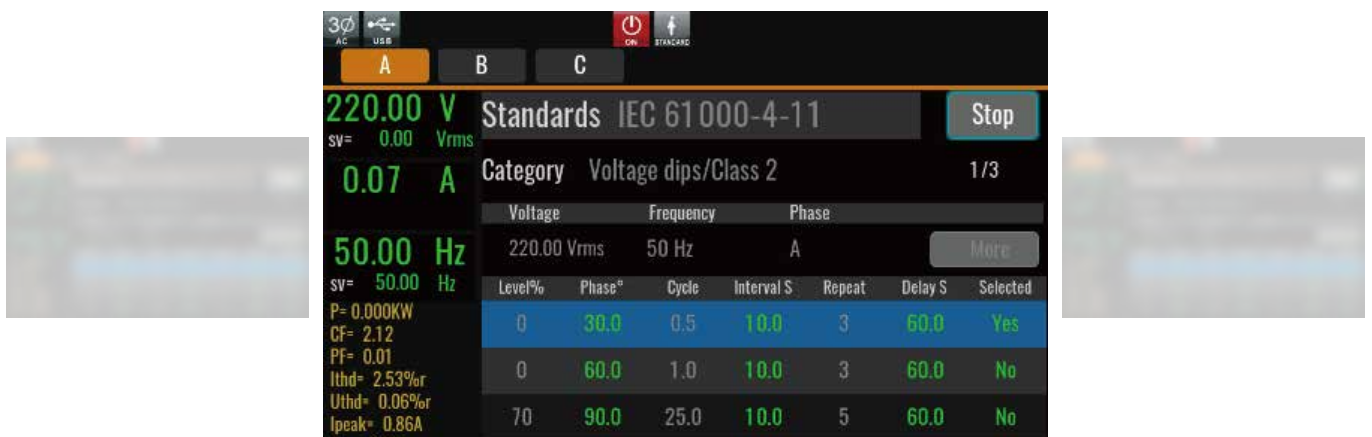

IT7900EP High Performance Regenerative Grid Simulator

AC/DC load conditions emulation

DC load mode

Constant Voltage (CV)

Constant Current (CC)

Constant Resistance (CR)

Constant Power (CP)

CC+CV

CR+CV

CP+CV

CC+CR

CP+CV+CR+CC

AC load mode

Constant Current (CC)

Constant Resistance (CR)

Constant Power (CP)

Constant apparent power (CS)

CC+CR

CE RLC

Single rectified RLC
Parallel RLC

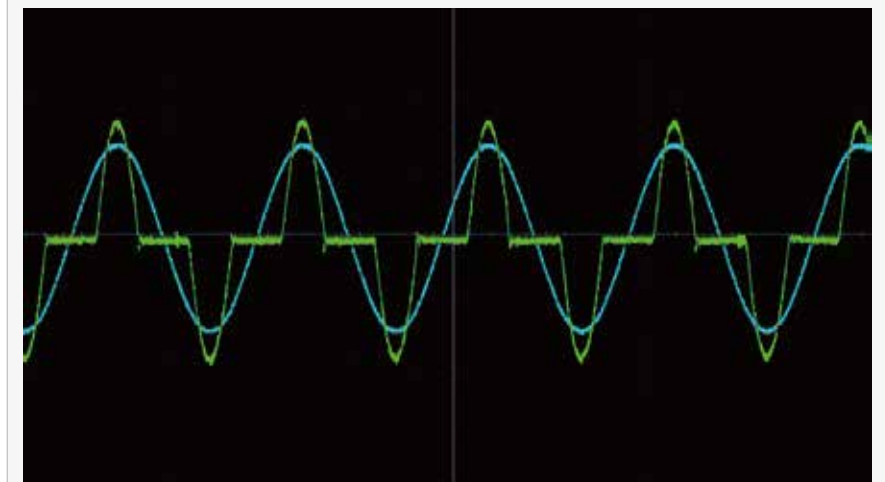
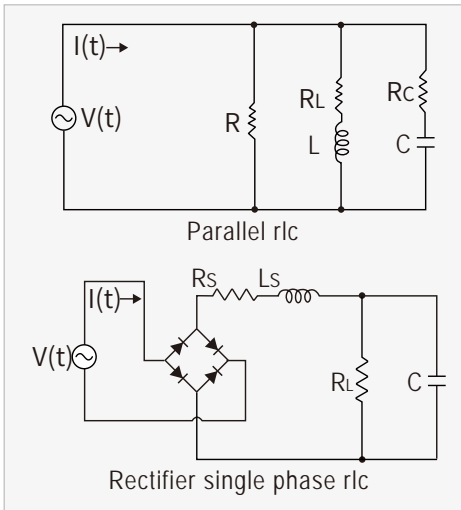

IT7900EP AC electronic load can enable the 'Rectified' function in AC mode, so that the load works in the first and third quadrants to ensure that the voltage and current flow always in the same direction. At this time, full wave, positive half wave, or negative half wave can be freely selected.

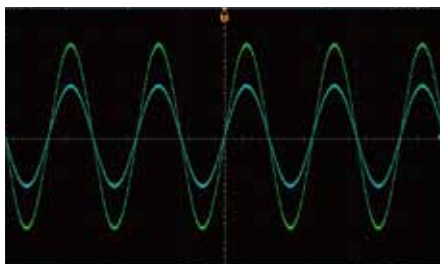

full wave rectification

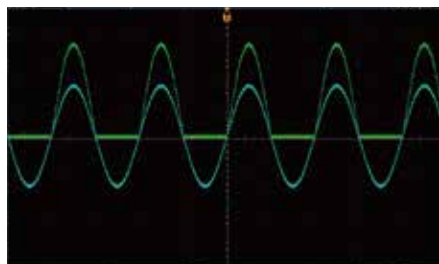

Positive half wave rectification

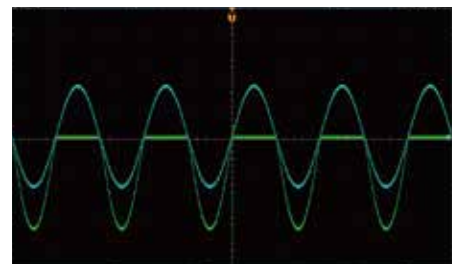

Negative half-wave rectification

CF 1.414-5.0

The crest factor indicates the extreme peaks of the waveform. For applications that require a pure sine wave, it is desirable to have a CF value of the load current waveform of 1.414 or as close as possible. However, in practical applications, the peak shape of the current waveform of the load may become very sharp and its CF is often higher than 1.414. At this time, the starting point of the sine wave starts to shift from 0 degrees to the positive degree. So you need to correct the waveform. The Crest Factor of the IT8200 can be adjusted from 1.414 to 5.0, and it also allows to set the phase shift angle from -90° ~ 90° , correct the resulting amplitude, and keep the RMS unchanged. This enables more accurate simulation of field test conditions to ensure the reliability of the unit under test (UUT).



CC mode,CF=5



CC mode,CF=1.414



Phase= 90°



Phase= -90°

CC phase leading / lagging



Multiple operation modes

AC,DC,AC+DC,DC+AC four working mode

IT7900EP series can be used as a "full four-quadrant AC/DC power supply" and provides four output modes: AC, DC, AC+DC, and DC+AC. Not only provide pure AC/DC output, use AC+DC and DC+AC output modes to realize "AC output superimposed DC bias" and simulate "DC output waveform with ripple" to meet the complex application requirements of engineers. In DC mode, the rated power in 100% AC mode can be achieved.

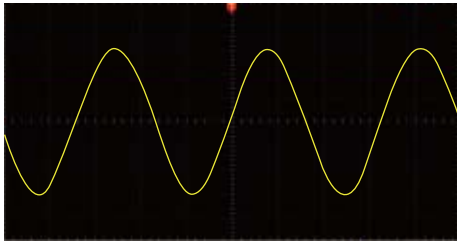

AC

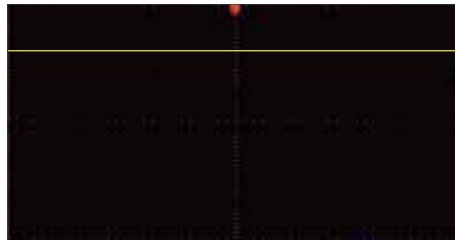

DC

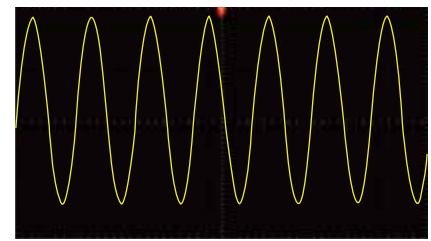
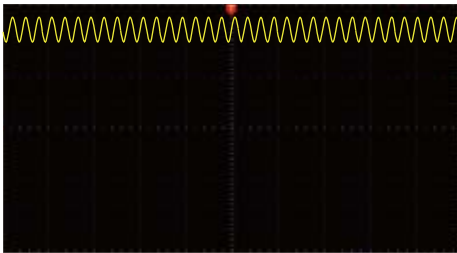
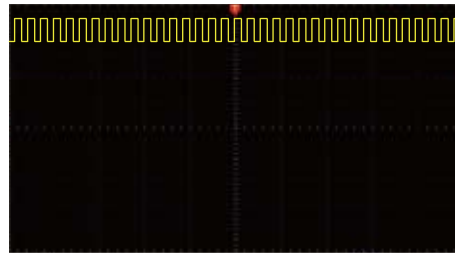
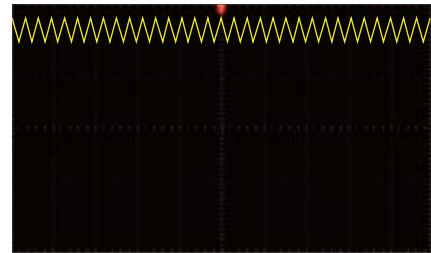
AC+DC
Vac=45V,dc bias=10VDC+AC
Vdc=50V, sine ripple Vac=5V,
frequency 150HzDC+AC
Vdc=50V, square ripple Vac=5V,
frequency 150HzDC+AC
Vdc=50V, triangle ripple Vac=5V,
frequency 150Hz

Measurement Functions

Data record

Thanks to the function of large data recording, IT7900EP series is capable of recording up to 7 hours of continuous data at short intervals (fastest: 100ms). And it's easy to view the complete curve generating from the start to the end of the test. There are six curves that can be displayed at the same time at most. In addition, you can slide the vernier calipers on the screen to check the exact data at a particular point in the current trend curves. It is useful for analyzing errors during test for a long time or inflection points during loading, etc. Besides, you can export the test data for further analysis by front panel USB interface



Harmonic analysis

Harmonic analysis functions include both voltage and current harmonic measurement. In the harmonic mode, the voltage and current total harmonic distortion (THD) and the phase difference test of the harmonic to the fundamental wave can be realized. In addition, you can make multiple harmonic measurements. The test results are displayed in a list, histogram or vector diagram, easy to check.

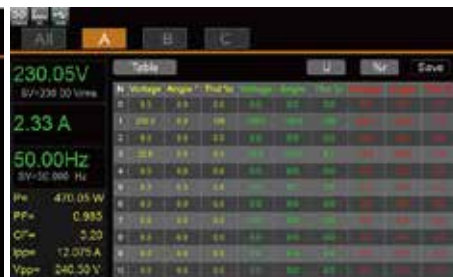

Powerful waveform editing function

Built-in various type of distorted waveforms

In addition to sine waveform, IT7900EP series provides various standard AC waveforms, such as triangular wave, sawtooth wave, square wave, trapezoidal wave and clipped sine wave. These waves can be easily recall from the menu and displayed in the LCD touch screen. Moreover, in combination with sequence programming function, users can realize multiple waveform continuous output, to cope with complex power line disturbance test.

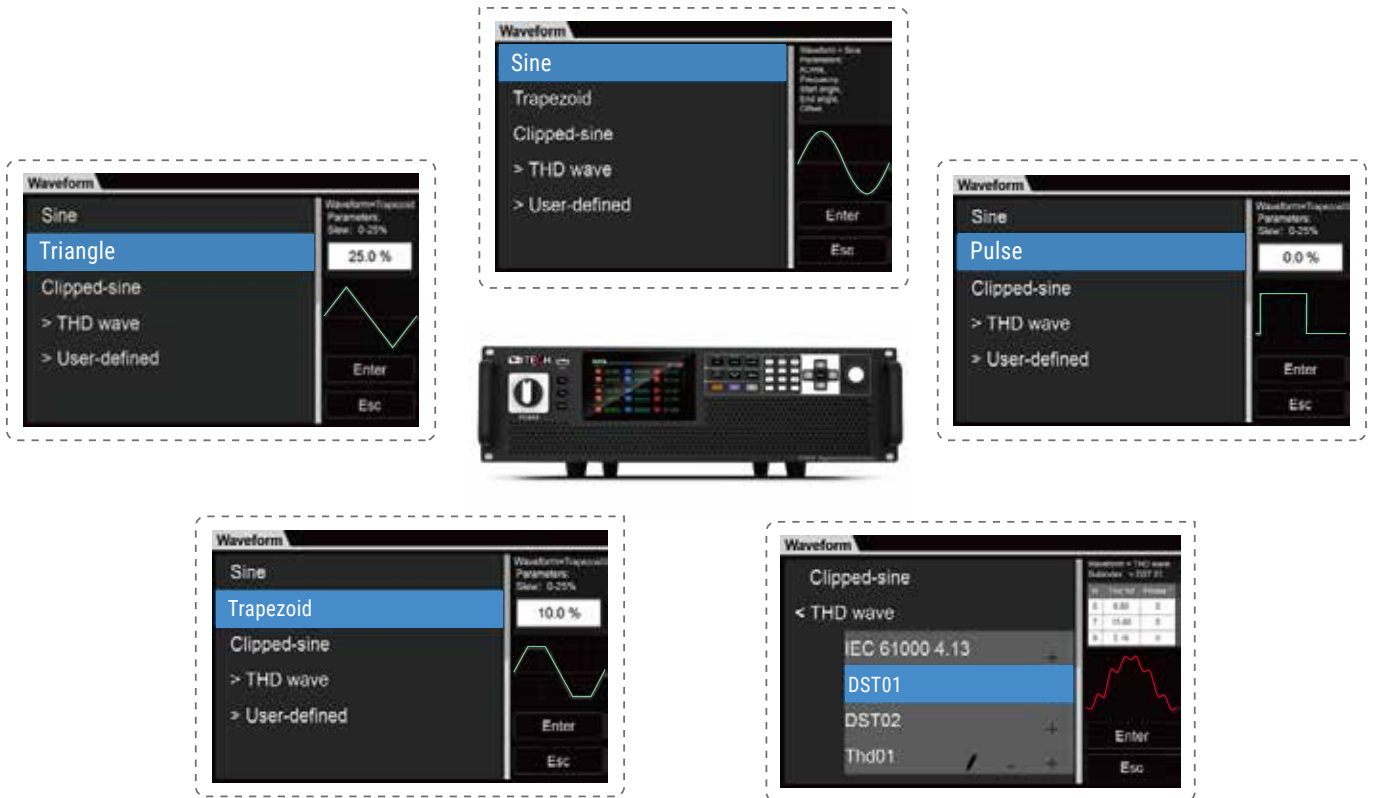

User-defined waveform function

IT7900EP series provides user-defined waveform editing function that allows users to simulate the effects of real AC or DC power supply systems on DUT's in different test environments by importing real waveform data into the device, it supports up to 1024 points of data import.

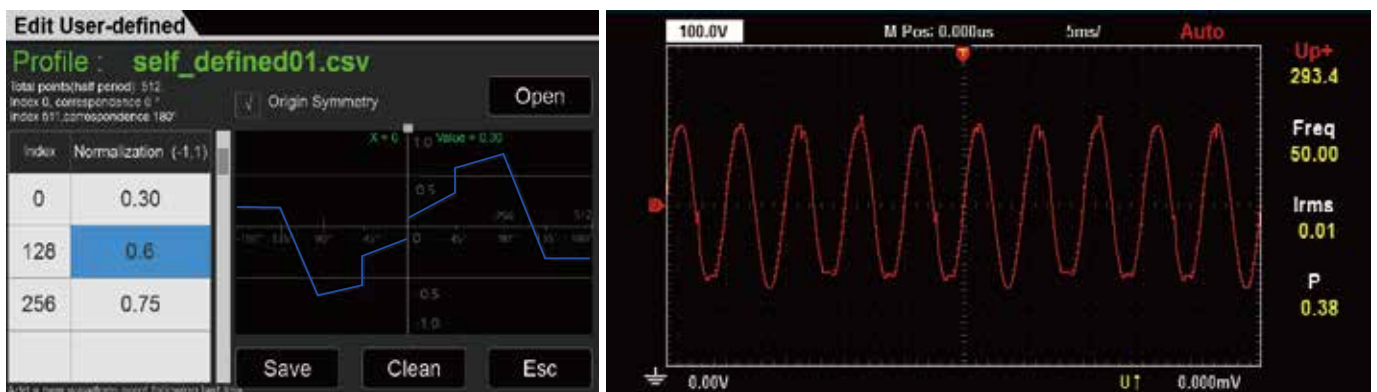

Simulate power grid and low voltage ride through (LVRT) testing

Low voltage ride-through refers to the ability of the power generation system to continue to operate without disconnecting from the grid within a certain range of voltage drop when the grid fault or disturbance causes a voltage drop, and even provides a reactive power to help the system recover the voltage. You can edit the test parameters under LVRT condition. With the fast response, it can fully meet the test requirements of LVRT. At the same time, the IT7900EP series has the function of arbitrary waveform. With the LIST function, it can edit and simulate various grid disturbance waveforms through the panel or software, such as instantaneous power failure, surge and voltage rise and fall.

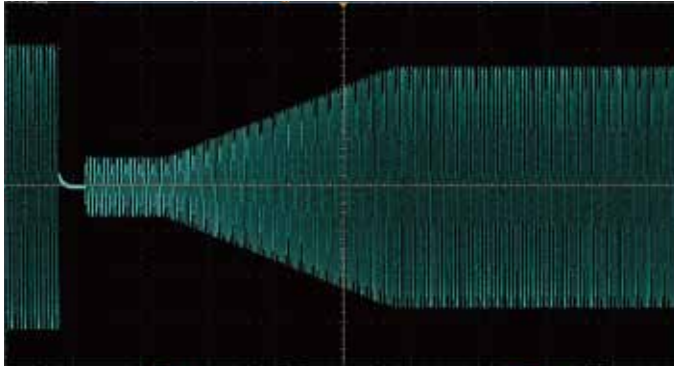

LVRT

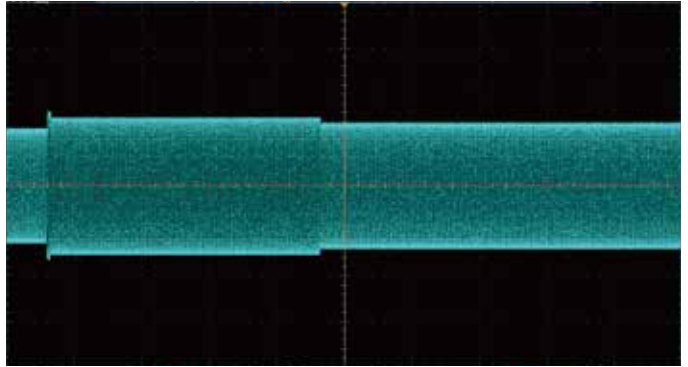

HVRT

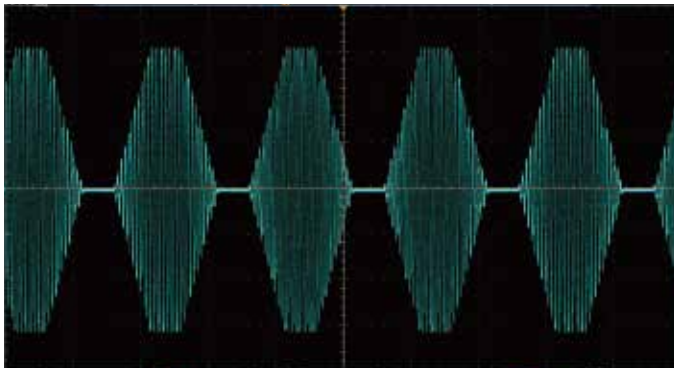

slow rise and fall

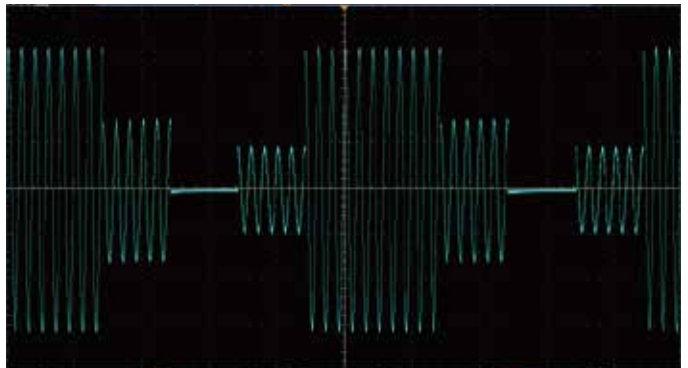

instantaneous power failure

Harmonic and inter-harmonic simulation

With high-speed DSP technology, IT7900EP series is capable of simulating harmonic, inter-harmonic and harmonic synthesis. By setting the amplitude and phase, it can simulate up to 50th harmonics (fundamental frequency is 50Hz or 60Hz), creating a periodic distortion waveform. It also has built-in 30 types harmonic distortion waveforms for quick recall. Harmonic test is one of the important tests for EMC immunity, and single-phase harmonics, three-phase harmonics and three-phase harmonic unbalance output can be realized, also meet IEC regulations test requirements.

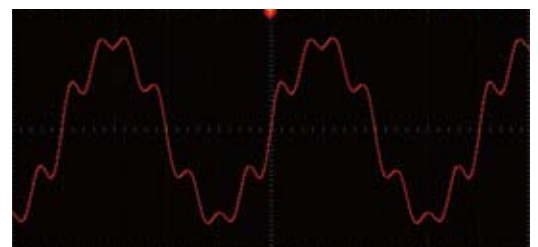
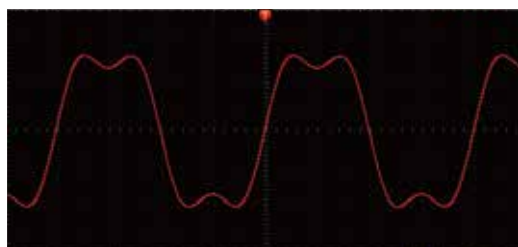
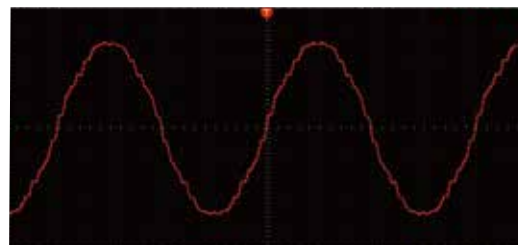
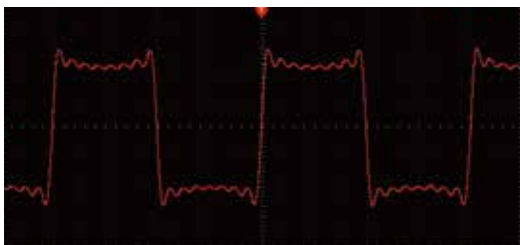

LIST/SWEEP/Surge & Sag modes

IT7900EP series supports **NORMAL,LIST and SWEEP mode**. Each mode can work with **Surge&Sag function**.

- In LIST mode, a single file supports up to 200 steps, and the waveform type, voltage, frequency, slope and start-stop phase angle can be selected under each step. When the output voltage or frequency jumps, a trigger signal can be generated to synchronize external devices, which is especially suitable for large-scale test platforms with strict logic control and fast response for inter-device linkage.
- SWEEP is suitable for AC mode, which can test the efficiency of switching power supply, grab the voltage and frequency of the maximum power point, and change the setting parameters in a step-by-step way.

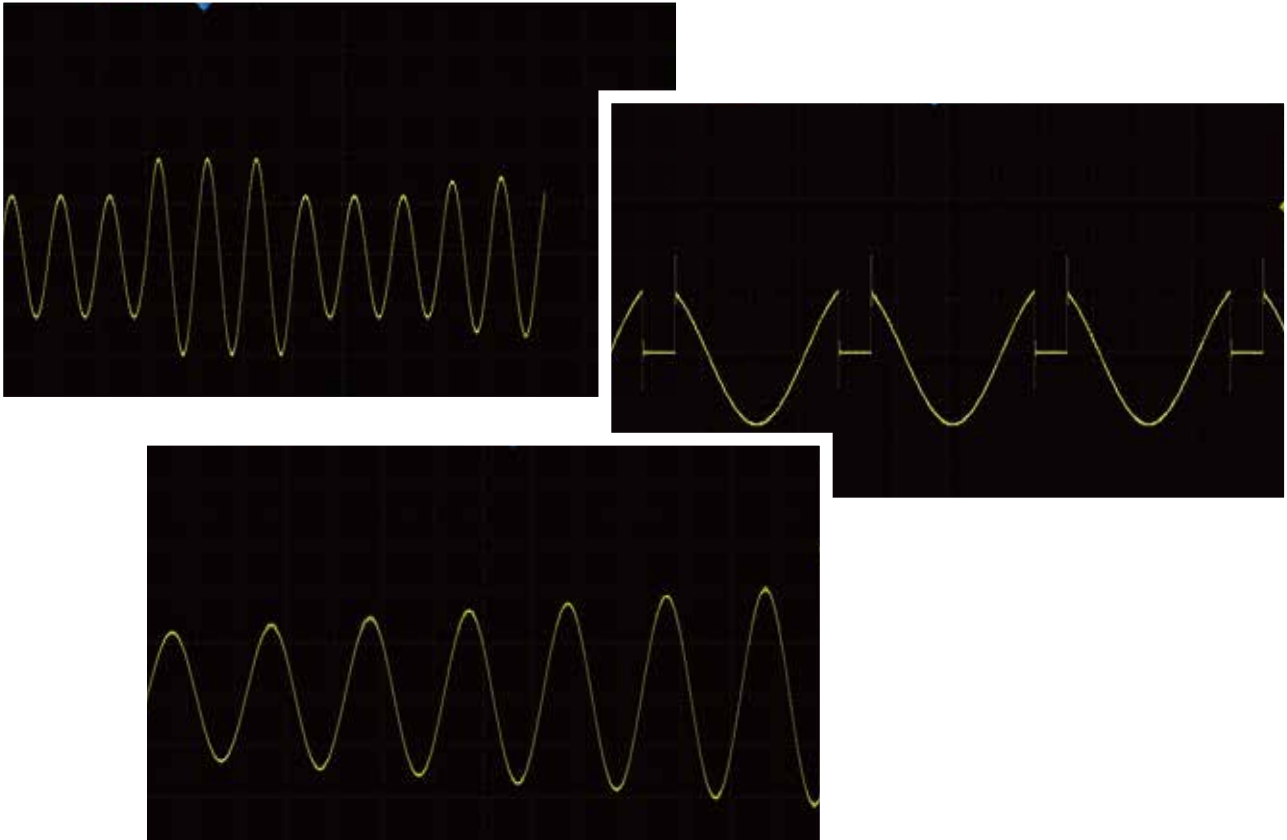

Intuitive software interface

IT7900EP series provides free PC software PV7900P with an intuitive GUI. Meanwhile, it allows remote control, even the ATE models without display screen can be programmed, communicated and monitored.

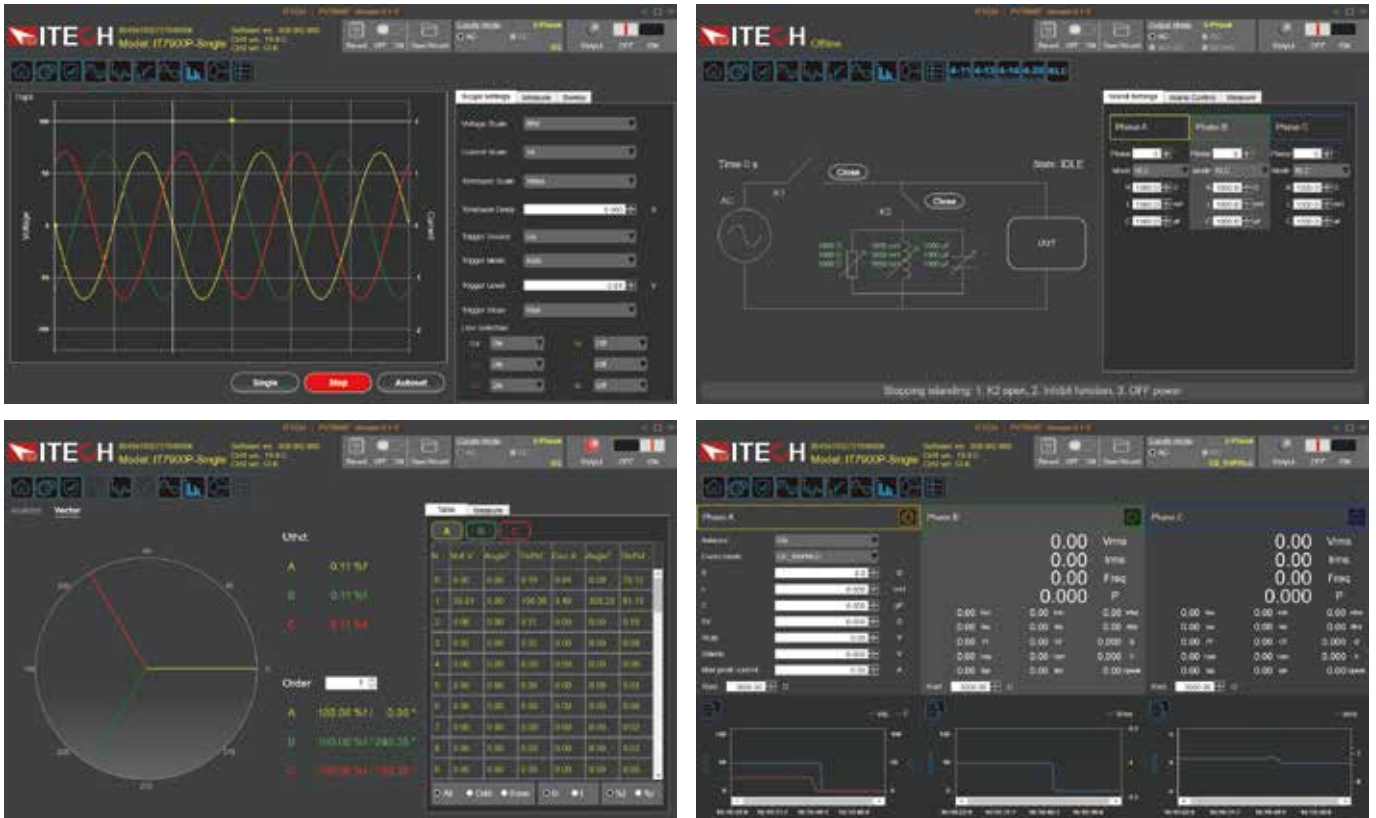

Optional Accessories

Item	Model	Specification	Description
Parallel kit	IT-E510-15U *1	15U unit, grey	800mm X 550mm X907.64mm
	IT-E511-15U *1	15U unit, black	800mm X 550mm X907.64mm
	IT-E510-27U *1	27U unit, grey	800mm X 600mmX 1441.41mm
	IT-E511-27U *1	27U unit, black	800mm X 600mmX 1441.41mm
	IT-E510-37U *1	37U unit, grey	800mm X 600mm X 1885.91mm
	IT-E511-37U *1	37U unit, black	800mm X 600mm X 1885.91mm
	IT-E168	fiber kit for parallel	for single unit
	IT-E169	fiber kit for parallel	for cabinet
Other accessories	IT-E258	power cord for 3U unit, 5m, US standard	AC input power cord
	IT-E258-15U	power cord for 15U cabinet, 5m, US standard	AC input power cord
	IT-E258-27U	power cord for 27U cabinet, 5m, US standard	AC input power cord
	IT-E258-37U	power cord for 37U cabinet, 5m, US standard	AC input power cord
	IT-E176	GPIB	
	IT-E177	RS232 & analog	

*1 There is standard cabinet for models >30kVA



IT-E511-27U

Input parameters (connect to grid)			
AC Input	wiring connection	3 phase 3wire + ground(PE)	
	Line voltage	RMS (200V ~ 220V) ±10% *1 (380V ~ 480V) ±10%	
	Line current	RMS < 47A	
	Apparent Power	< 24.4kVA	
	Frequency	45 ~ 65Hz	
	Power factor	typ 0.98	
Output parameters (connect to EUT) (connect to grid)			
AC Output	Output voltage	VLN *2	0 ~ 350V
		VLL	0 ~ 606V (3phase) / 0 ~ 700V (reverse)
	Output current	RMS	105A (1phase) / 35A (3phase/reverse)
		Crest Factor *3	6
		Peak	315A (1phase) / 105A (3phase/reverse)
	Output power	Per Phase/Per Channel	7kVA
		Max. Power	14kVA (reverse phase) / 21kVA (1phase/3phase)
	Voltage setting		
	Range	0 ~ 350V (1phase/3phase) / 0 ~ 700V (reverse)	
	Resolution	0.01V	
	Accuracy	< 0.1%+0.1% F.S. (16Hz ~ 500Hz) / < 0.1%+(0.2%*kHz)F.S. (500.01Hz ~ 2.4kHz)	
	DC offset voltage	typ	0.02Vdc
	Current Limit setting		
	Range	RMS	105A (1phase) / 35A (3phase/reverse)
Resolution	0.01A		
Accuracy	< 0.1% + 0.2% F.S. (16Hz ~ 150Hz) / < 0.2% + 0.3% F.S. (150.01Hz ~ 500Hz) / < 0.3%+(0.6%*kHz) F.S (500.01Hz ~ 2.4kHz)		
Frequency			
Range	16 ~ 500Hz (Low *4) / 16 ~ 2.4k (High *4)		
Resolution	0.01Hz		
Accuracy	0.01% (16Hz ~ 500Hz) / 0.1% (500.01Hz ~ 2.4kHz)		
waveform synthesis	50/60Hz	up to 50 orders	
Phase			
Range	0 ~ 360°		
Resolution	0.01°		
DC Output	voltage setting		
	Range	-499 ~ 499Vdc (1phase) / -998 ~ 998Vdc (reverse)	
	Resolution	0.01V	
	Accuracy	< 0.1%+0.1% F.S	
	Current setting		
	Range	-35 ~ 35Adc (reverse) / -105 ~ 105Adc (1phase)	
	Resolution	0.01A	
	Accuracy	< 0.1% + 0.2% F.S.	
	Max. power		
	Phase power	Per Channel	7kW
Max.power (reversephase)	Max. Power (reverse phase)	14kW	
Total power	Max. Power (1phase)	21kW	
Voltage stability	Line regulation	< 0.05% F.S.	
	Load regulation*5	< 0.05% + 0.05% F.S.(DC,16Hz ~ 500Hz) / < 0.05% + (0.1%*kHz) F.S(500.01Hz ~ 2.4kHz)	
	THD *6	< 0.5%(16Hz ~ 100Hz) / < 1%(100.01Hz ~ 500Hz) / < 1%+(1%*kHz) F.S.(500.01Hz ~ 2.4kHz)	
	Voltage ripple	RMS	< 0.4V
	Dynamic response*7	typ	200us
Programmable impedance	R Range	0 ~ 1000mΩ(3phase) / 0 ~ 333.333mΩ(1phase) / 0 ~ 2000mΩ(reverse)	
	L Range	0 ~ 1000uH (3phase) / 0 ~ 333.333uH (1phase) / 0 ~ 2000uH (reverse)	
RLC	P Range	0 ~ 7kW (3phase) / 0 ~ 21kW (1phase) / 0 ~ 14kW (reverse)	
	QL Range	0 ~ 7kVar (3phase) / 0 ~ 21kVar (1phase) / 0 ~ 14kVar (reverse)	
	QC Range	0 ~ 7kVar (3phase) / 0 ~ 21kVar (1phase) / 0 ~ 14kVar (reverse)	
	R Range	1 ~ 1000Ω (3phase) / 0.333 ~ 333.333Ω (1phase) / 2 ~ 2000Ω (reverse)	
	L Range	1 ~ 5000mH (3phase) / 0.333 ~ 1666.667mH (1phase) / 2 ~ 10000mH (reverse)	
	C Range	0.001 ~ 5mF (3phase) / 0.003 ~ 15mF (1phase) / 0.001 ~ 2.5mF (reverse)	
	Voltage Slew Rate, Typical	≥ 2 V/μs with full-scale programmed voltage step	
Output Isolation	550Vac		
Output parameters (electronic load mode)			
AC Mode	Input voltage	VLN	30 ~ 350V
		VLL	51.96 ~ 606V (3phase) 30 ~ 700V (reverse)
	Input frequency	16~500Hz	
	Input current	RMS	105A (1phase) / 35A (3phase/reverse)
		Crest Factor *8	5
		Peak	315A (1phase) / 105A (3phase/reverse)
	Input power	Per Phase	7kVA (3phase)
		Max. Power	14kVA (reverse phase) / 21kVA (1phase/3phase)
	CC Mode		
	Current range	RMS	105A (1phase) / 35A (3phase/reverse)
Resolution	0.01A		
Accuracy*9	< 0.1% + 0.2% F.S. (DC,16Hz ~ 150Hz) / < 0.2% + 0.3% F.S.(150.1Hz ~ 500Hz *10)		
CP Mode			
Range	Max. Power	21kW (1phase/3phase) / 14kW (reverse phase)	
	Per Phase	7kW (3phase)	
Resolution	0.001kW		
Accuracy	< 0.4% + 0.4% F.S. (DC,16Hz ~ 500Hz)		

AC Mode	CS Mode			
	Range	Max. Power	21kVA (1phase/3phase) / 14kVA (reverse phase)	
		Per Phase	7kVA (3phase)	
		Resolution	0.001kVA	
		Accuracy	<0.4% +0.4% F.S. (16Hz ~ 500Hz)	
	CR Mode			
		Range	0.334 ~ 388.88Ω(1phase) / 1.002 ~ 1166.6Ω (reverse phase) / 1.002 ~ 1166.6(3phase)	
		Resolution	0.001Ω	
		Accuracy*11	0.4%+0.4%F.S.	
	Parallel rlc: Circuit Emulation(CE)-Parallel rlc			
		R Range	0.334 ~ 388.88Ω(1phase) / 1.002 ~ 1166.6(reverse phase) / 1.002 ~ 1166.6(3phase)	
		L Range	1 ~ 2000mH (1phase) / 3 ~ 2000mH (reverse phase) / 3 ~ 2000mH(3phase)	
		C Range	0.001 ~ 9900uF (1phase) / 0.001 ~ 3300uF (reverse phase) / 0.001 ~ 3300uF (3phase)	
		Rc Range	0.334 ~ 388.88Ω(1phase) / 1.002 ~ 1166.6Ω (reverse phase) / 1.002 ~ 1166.6 (3phase)	
		RL Range	0.334 ~ 388.88Ω(1phase) / 1.002 ~ 1166.6Ω(reverse phase) / 1.002 ~ 1166.6(3phase)	
		IL Range	0 ~ 318.15A (1phase) / 0 ~ 106.05A (reverse phase) / 0 ~ 106.05A (3phase)	
		Max peak current	318.15A (1phase) / 106.05A (reverse phase) / 106.05A (3phase)	
	Rectifier single phase rlc: Circuit Emulation(CE)-Rectifier single phase rlc			
		R Range	0.334 ~ 388.88Ω(1phase) / 1.002 ~ 1166.6(reverse phase) / 1.002 ~ 1166.6(3phase)	
		L Range	0.1 ~ 2000mH(1phase) / 0.3 ~ 2000mH (reverse phase) / 0.3 ~ 2000mH (3phase)	
		C Range	0.001 ~ 9900uF (1phase) / 0.001 ~ 3300uF (reverse phase) / 0.001 ~ 3300uF (3phase)	
		RS Range	0 ~ 388.88Ω(1phase) / 0 ~ 1166.6Ω (reverse phase) / 0 ~ 1166.6Ω(3phase)	
		Vcap Range	0 ~ 499.924V (1phase) / 0 ~ 499.924V (reverse phase) / 0 ~ 499.924V (3phase)	
		Vdiode Range	0 ~ 5V (1phase) / 0 ~ 5V (reverse phase) / 0 ~ 5V (3phase)	
		Max peak current	318.15A (1phase) / 106.05A (reverse phase) / 106.05A (3phase)	
	Phase Range			
		Range	Rectified Mode *12	-82.8°~+82.8°
				-180° ~ +180°(Current Source Mode: +90.01° ~ +180° & -90.01° ~ -180°)
		Resolution	0.01°	
		Accuracy*13	1% F.S.	
	CF setting			
		Range	1.414 ~ 5.0	
	Resolution	0.001		
PF setting				
	Range	0 ~ 1.00		
	Resolution	0.01		
DC Mode	voltage range	30 ~ 499 (1phase) / 30 ~ 998 (reverse phase)		
	current range	0 ~ 105A (1phase) / 0 ~ 35 (reverse phase)		
	current rise time	200us		
	working mode	CC, CV, CR, CP, CC+CV, CR+CV, CP+CV, CC+CR, CC+CV+CP+CR		
Measurement parameter (grid simulator mode)				
Voltage RMS	Resolution	0.01V		
	Accuracy	<0.1%+0.1% F.S. (DC,16Hz~500Hz) / <0.1%+(0.2%*kHz) F.S (500.01Hz~2.4kHz)		
Current RMS	Resolution	0.1A		
	Accuracy	<0.1% + 0.2% F.S. (DC,16Hz ~ 150Hz) / <0.2% + 0.3% F.S. (150.01Hz~500Hz) / <0.3% + (0.6%*kHz) F.S (500.01Hz~2.4kHz)		
Peak current	Resolution	0.1A		
	Accuracy	<0.4% + 0.6% F.S. (16Hz~500Hz) / <0.4% + (1.2%*kHz) F.S (500.01Hz~2.4kHz)		
Output power	Resolution	0.001kW		
	Accuracy	<0.4%+0.4% F.S. (DC,16Hz~500Hz) / <0.4% + (0.8%*kHz) F.S (500.01Hz~2.4kHz)		
Harmonic measurement	Max.	50/60Hz	up to 50 orders	
Measurement parameter (electronic load mode)				
Voltage RMS	Range	0 ~ 350Vrms		
	Resolution	0.01V		
	Accuracy	<0.1%+0.1% F.S. (DC,16Hz~500Hz)		
Current RMS	Range	0 ~ 105A		
	Resolution	0.1A		
	Accuracy	<0.1% + 0.2% F.S. (DC,16Hz ~ 150Hz) / <0.2% + 0.3% F.S. (150.1Hz ~ 500Hz)		
Peak current	Range	0 ~ 315A		
	Resolution	0.1A		
	Accuracy	<0.3% + 0.6% F.S. (16Hz~500Hz)		
Active power	Range	0 ~ 21kW		
	Resolution	0.001kW		
	Accuracy	<0.4% +0.4% F.S.		
Reactive power	Range	0 ~ 21kVAR		
	Resolution	0.001kVAR		
	Accuracy	<0.4% +0.4% F.S.		
Apparent power	Range	0 ~ 21KVA		
	Resolution	0.001KVA		
	Accuracy	<0.4% +0.4% F.S.		
CF measurement	Range	1 ~ 5		
	Resolution	0.01		
PF measurement	Range	0.1 ~ 1		
	Accuracy	1%F.S.		

IT7900EP High Performance Regenerative Grid Simulator

Harmonic measurement	Max.	50/60Hz	up to 50 orders
Regenerative			
Max. Regenerative power		21kVA	
THD		< 5%	
Others			
Efficiency	typ*14	91%	
Protection		OVP, OCP, OPP, OTP, FAN, ECP, Sense, UVP(load), FE(load)	
dimension		483.00mm(W)*151.30mm(H)*777.50mm(D)(841.6mm cover and holder included)	
Weight		42kg	
Working temperature		0 C -50 C	
Programming response time		2ms	
Remote Sense Compensation Voltage		20V	
Communication interface		Built in USB/CAN/LAN/digital IO communication interface, optional GPIB/analog&RS232 communication interface	

*1 (200~220) ±10%, power is 60% of the rated.

*2 Depending on the frequency, the output voltage will decrease. The rated voltage can be output below 1.4kHz, the maximum output voltage at 2kHz is 250.76Vrms, and the maximum output voltage at 2.4kHz is 208.97Vrms.

*3 When the output frequency is below 50Hz/60Hz, and the peak current is not exceeded, the maximum CF is 6; under the condition of full current and full power, the maximum CF is 3.

*4 When LoopSpeed is low, it can better complied DUT's characteristics; When LoopSpeed is High, the dynamic response time will be faster.

*5 Parallel models need to use sense remote measurement mode for testing.

*6 Test condition: pure resistive load, under full power condition.

*7 Dynamic response time test condition, DC mode, high speed, capacitance of DUT < 10uF.

*8 When the input frequency is below 50Hz/60Hz, and the peak current is not exceeded, the maximum CF is 5; under the condition of full current and full power, the maximum CF is 3.

*9 For frequency < 150Hz, the minimum current for accuracy test is 1%F.S., for frequency > 150Hz, the minimum current for accuracy test is 3%F.S.

*10 When LoopSpeed is Low, it is more adaptable to the load; when LoopSpeed is Fast, the dynamic response is faster; when the frequency is high, please use Fast mode.

*11 Under condition: $I > 10\%F.S.$, $F < 150Hz$

*12 In the rectifier load mode, the setting range of the phase angle is related to CF. The larger the CF, the larger the set range of the phase angle.

*13 $\leq 150Hz$, 1%F.S., $> 150Hz$, 5%F.S.

*14 Test conditions: Input 380VLL/50Hz, output three-phase, each phase 350Vrms/50Hz/7kW.

*All the above parameters are subject to change without prior notice from ITECH.

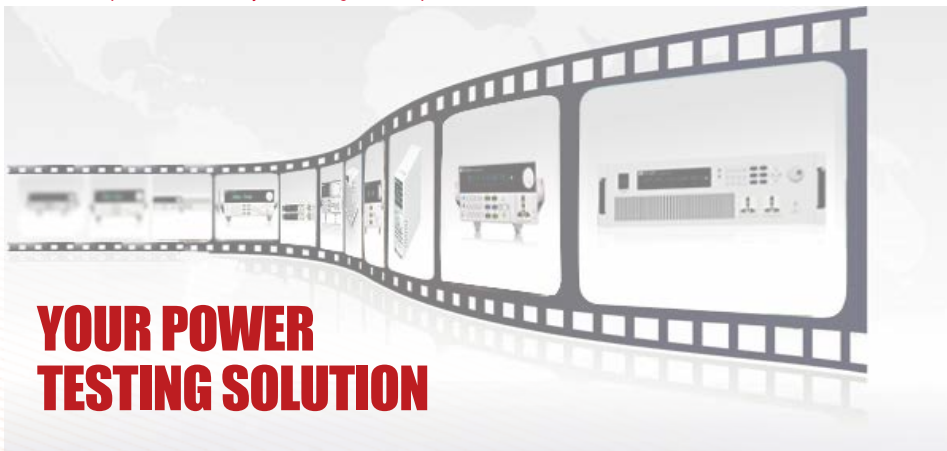

This information is subject to change without notice. For more information, please contact ITECH.

Taipei

Add: No.918, Zhongzheng Rd., Zhonghe Dist., New Taipei City
235, Taiwan

Web: www.itechate.com

TEL: +886-3-6684333

E-mail: info@itechate.com



ITECH Web



ITECH Facebook



ITECH LinkedIn