

# High Performance Regenerative Grid Simulator IT7900P Series Programming Guide



---

Model: IT7900P  
Version: V2.0/2025.10

## Notices

© Itech Electronic, Co., Ltd. 2025  
No part of this manual may be reproduced in any form or by any means (including electronic storage and retrieval or translation into a foreign language) without prior permission and written consent from Itech Electronic, Co., Ltd. as governed by international copyright laws.

### Manual Part Number

IT7900P

### Revision

2nd Edition: OCT.19, 2025

Itech Electronic, Co., Ltd.

### Trademarks

Pentium is U.S. registered trademarks of Intel Corporation.

Microsoft, Visual Studio, Windows and MS Windows are registered trademarks of Microsoft Corporation in the United States and/or other countries and regions.

## Warranty

The materials contained in this document are provided “as is”, and is subject to change, without prior notice, in future editions. Further, to the maximum extent permitted by applicable laws, ITECH disclaims all warranties, either express or implied, with regard to this manual and any information contained herein, including but not limited to the implied warranties of merchantability and fitness for a particular purpose. ITECH shall not be held liable for errors or for incidental or indirect damages in connection with the furnishing, use or application of this document or of any information contained herein. Should ITECH and the user enter into a separate written agreement with warranty terms covering the materials in this document that conflict with these terms, the warranty terms in the separate agreement shall prevail.

### Technology Licenses

The hardware and/or software described herein are furnished under a license and may be used or copied only in accordance with the terms of such license.

### Restricted Rights Legend

Restricted permissions of the U.S. government. Permissions for software and technical data which are authorized to the U.S. Government only include those for custom provision to end users. ITECH follows FAR 12.211 (technical data), 12.212 (computer software). DFARS 252.227-7015 (technical data--commercial products) for national defense and DFARS 227.7202-3 (permissions for commercial computer software or computer software documents) while providing the customized business licenses of software and technical data.

## Safety Notices

### CAUTION

A CAUTION sign denotes a hazard. It calls attention to an operating procedure or practice that, if not correctly performed or adhered to, could result in damage to the product or loss of important data. Do not proceed beyond a CAUTION sign until the indicated conditions are fully understood and met.

### WARNING

A WARNING sign denotes a hazard. It calls attention to an operating procedure or practice that, if not correctly performed or adhered to, could result in personal injury or death. Do not proceed beyond a WARNING sign until the indicated conditions are fully understood and met.



### NOTE

A NOTE sign denotes important hint. It calls attention to tips or supplementary information that is essential for users to refer to.

## Quality Certification and Assurance

We certify that IT7900P electronic load meets all the published specifications at time of shipment from the factory.

## Warranty

ITECH warrants that the product will be free from defects in material and workmanship under normal use for a period of one (1) year from the date of delivery (except those described in the Limitation of Warranty below).

For warranty service or repair, the product must be returned to a service center designated by ITECH.















- The product returned to ITECH for warranty service must be shipped PREPAID. And ITECH will pay for return of the product to customer.
- If the product is returned to ITECH for warranty service from overseas, all the freights, duties and other taxes shall be on the account of customer.

## Limitation of Warranty

This Warranty will be rendered invalid in case of the following:

- Damage caused by circuit installed by customer or using customer own products or accessories;
- Modified or repaired by customer without authorization;
- Damage caused by circuit installed by customer or not operating our products under designated environment;
- The product model or serial number is altered, deleted, removed or made illegible by customer;
- Damaged as a result of accidents, including but not limited to lightning, moisture, fire, improper use or negligence.

## Safety Symbols

	Direct current		ON (power on)
	Alternating current		OFF (power off)
	Both direct and alternating current		Power-on state
	Protective conductor terminal		Power-off state
	Earth (ground) terminal		Reference terminal
	Caution, risk of electric shock		Positive terminal
	Warning, risk of danger (refer to this manual for specific Warning or Caution information)		Negative terminal

	Frame or chassis terminal	-	-

## Safety Precautions

The following safety precautions must be observed during all phases of operation of this instrument. Failure to comply with these precautions or specific warnings elsewhere in this manual will constitute a default under safety standards of design, manufacture and intended use of the instrument. ITECH assumes no liability for the customer's failure to comply with these precautions.

### WARNING

- Do not use the instrument if it is damaged. Before operation, check the casing to see whether it cracks. Do not operate the instrument in the presence of inflammable gasses, vapors or dusts.
- The power supply is provided with a three-core power line during delivery and should be connected to a three-core junction box. Before operation, be sure that the instrument is well grounded.
- Make sure to use the power cord supplied by ITECH.
- Check all marks on the instrument before connecting the instrument to power supply.
- Use electric wires of appropriate load. All loading wires should be capable of bearing maximum short-circuit current of power supply without overheating. If there are multiple electronic loads, each pair of the power cord must be capable of bearing the full-loaded rated short-circuit output current.
- Ensure the voltage fluctuation of mains supply is less than 10% of the working voltage range in order to reduce risks of fire and electric shock.
- Do not install alternative parts on the instrument or perform any unauthorized modification.
- Do not use the instrument if the detachable cover is removed or loosen.
- To prevent the possibility of accidental injuries, be sure to use the power adapter supplied by the manufacturer only.
- We do not accept responsibility for any direct or indirect financial damage or loss of profit that might occur when using the instrument.
- This instrument is used for industrial purposes, do not apply this product to IT power supply system.
- Never use the instrument with a life-support system or any other equipment subject to safety requirements.

### CAUTION

- Failure to use the instrument as directed by the manufacturer may render its protective features void.
- Always clean the casing with a dry cloth. Do not clean the internals.
- Make sure the vent hole is always unblocked.

## Environmental Conditions

The instrument is designed for indoor use and an area with low condensation.



The table below shows the general environmental requirements for the instrument.

Environmental Conditions	Requirements
Operating temperature	0°C to 50°C
Operating humidity	20%-80% (non-condensation)
Storage temperature	-20°C to 70 °C
Altitude	Operating up to 2,000 meters
Pollution degree	Pollution degree 2
Installation category	II

**Note**

To make accurate measurements, allow the instrument to warm up for 30 min before operation.

## Regulatory Markings

	<p>The CE mark indicates that the product complies with all the relevant European legal directives. The specific year (if any) affixed refers to the year when the design was approved.</p>
	<p>The instrument complies with the WEEE Directive (2002/96/EC) marking requirement. This affixed product label indicates that you must not discard the electrical/electronic product in domestic household waste.</p>
	<p>This symbol indicates the time period during which no hazardous or toxic substances are expected to leak or deteriorate during normal use. The expected service life of the product is 10 years. The product can be used safely during the 10-year Environment Friendly Use Period (EFUP). Upon expiration of the EFUP, the product must be immediately recycled.</p>

## Compliance Information

Complies with the essential requirements of the following applicable European Directives, and carries the CE marking accordingly:

- Electromagnetic Compatibility (EMC) Directive 2014/30/EU
- Low-Voltage Directive (Safety) 2014/35/EU

Conforms with the following product standards:

### EMC Standard

IEC 61326-1:2012/ EN 61326-1:2013 <sup>123</sup>

#### Reference Standards

CISPR 11:2009+A1:2010/ EN 55011:2009+A1:2010 (Group 1, Class A)

IEC 61000-4-2:2008/ EN 61000-4-2:2009

IEC 61000-4-3:2006+A1:2007+A2:2010/ EN 61000-4-3:2006+A1:2008+A2:2010

IEC 61000-4-4:2004+A1:2010/ EN 61000-4-4:2004+A1:2010

IEC 61000-4-5:2005/ EN 61000-4-5:2006

IEC 61000-4-6:2008/ EN 61000-4-6:2009

IEC 61000-4-11:2004/ EN 61000-4-11:2004

1. The product is intended for use in non-residential/non-domestic environments. Use of the product in residential/domestic environments may cause electromagnetic interference.
2. Connection of the instrument to a test object may produce radiations beyond the specified limit.
3. Use high-performance shielded interface cable to ensure conformity with the EMC standards listed above.

### Safety Standard

IEC 61010-1:2010/ EN 61010-1:2010

## Content

Quality Certification and Assurance .....	iii
Warranty .....	iii
Limitation of Warranty .....	iii
Safety Symbols .....	iii
Safety Precautions .....	iv
Environmental Conditions .....	iv
Regulatory Markings .....	v
Compliance Information .....	vi
<b>Chapter1 SCPI Introduction .....</b>	<b>1</b>
1.1 Overview .....	1
1.2 Command Type of SCPI .....	1
1.3 Message Type of SCPI.....	3
1.4 Response Data Type .....	4
1.5 Command Format .....	5
1.6 Data Type .....	7
1.7 Remote Interface Connection .....	8
<b>Chapter2 Example of Common Commands.....</b>	<b>9</b>
Example 1: Identify the power supply.....	9
Example 2:Common output commands.....	9
Example 3: List function commands .....	10
Example 4: THD Wave commands.....	10
<b>Chapter3 SCPI status register .....</b>	<b>12</b>
<b>Chapter4 STATus Commands.....</b>	<b>16</b>
STATus:QUEStionable[:EVENT]? .....	16
STATus:QUEStionable:CONDition? .....	16
STATus:QUEStionable:ENABle <NR1> .....	17
STATus:QUEStionable:NTRansition <NR1> .....	17
STATus:QUEStionable:PTRansition .....	18
STATus:OPERation[:EVENT]? .....	18
STATus:OPERation:CONDition?.....	19
STATus:OPERation:ENABle <NR1> .....	19
STATus:OPERation:NTRansition<NR1> .....	20
STATus:OPERation:PTRansition .....	21
STATus:PRESet .....	21
<b>Chapter5 SYSTem Subsystem .....</b>	<b>22</b>
SYSTem:VERSIon? .....	22
SYSTem:ERRor?.....	22
SYSTem:PRESet .....	22
SYSTem:POSetup <CPD>.....	23
SYSTem:CLEar .....	23
SYSTem:REMOte .....	23
SYSTem:LOCal .....	24
SYSTem:RWLock .....	24
SYSTem:BEEPer:IMMediate .....	24
SYSTem:BEEPer[:STATe] <CPD>.....	25
SYSTem:BRIGhtness:LEVel <NR1>.....	25
SYSTem:TOUCh[:STATe] <CPD> .....	26
SYSTem:LANGuage <CPD>.....	26
SYSTem:SOFT:KEYBoard[:STATe] <CPD>.....	26
SYSTem:KNOB:IMMediate:EFFective <CPD> .....	27
SYSTem:COMMunicate:USB:TYPE <CPD>.....	27
SYSTem:COMMunicate:SElect <CPD>.....	28
SYSTem:COMMunicate:GPIB:ADDRess <NR1> .....	28
SYSTem:COMMunicate:SERial:BAUDrate <CPD>.....	29

SYSTEM:COMMunicate:LAN:IP[:CONFiguration] <ip> .....	29
SYSTEM:COMMunicate:LAN:IP[:CONFiguration]:MODE <CPD> .....	30
SYSTEM:COMMunicate:LAN:SMASK <SPD> .....	30
SYSTEM:COMMunicate:LAN:DGATeway <SPD> .....	31
SYSTEM:COMMunicate:LAN:RAWSocketport <port> .....	31
SYSTEM:OPERation:CATalog? .....	32
SYSTEM:OPERation:MODE <CPD> .....	32
SYSTEM:FUNcTION <CPD> .....	32
SYSTEM:FIBer:STATe? .....	33
<b>Chapter6      ABORt Subsystem .....</b>	<b>34</b>
ABORt:ACQuire .....	34
ABORt:LIST .....	34
ABORt:SWEep .....	34
ABORt:SURGesag .....	34
<b>Chapter7      INITiate Subsystem .....</b>	<b>35</b>
INITiate[:IMMediate]:ACQuire .....	35
INITiate[:IMMediate]:LIST .....	35
INITiate[:IMMediate]:SWEep .....	35
INITiate[:IMMediate]:SURGesag .....	35
<b>Chapter8      CONFigurate IO Subsystem .....</b>	<b>36</b>
[CONFigurable:]IO:SElect <NR1> .....	36
[CONFigurable:]IO:REVerse <NR1>,<CPD> .....	36
[CONFigurable:]IO:TYPE <NR1>,<CPD> .....	36
[CONFigurable:]IO:TOUT:SOURce <CPD1>,<CPD2> .....	37
[CONFigurable:]IO:STATe <NR1>,<CPD> .....	38
<b>Chapter9      TRIGger Subsystem .....</b>	<b>39</b>
TRIGger:LIST:SOURce <source> .....	39
TRIGger:SWEep:SOURce <CPD> .....	39
TRIGger:SURGesag:SOURce <CPD> .....	40
TRIGger:SCOPE:SOURce <CPD> .....	40
TRIGger:SCOPE:MODE <CPD> .....	40
TRIGger:SCOPE:SLOPe <CPD1> .....	41
TRIGger:FORCe .....	41
<b>Chapter10     PARAllel Subsystem .....</b>	<b>42</b>
PARAllel:ROLE <role> .....	42
PARAllel:NUMBer <number> .....	42
PARAllel:NODE:NUMBer? .....	43
<b>Chapter11     SCOPE Subsystem .....</b>	<b>44</b>
SCOPE:AUTO .....	44
SCOPE:RUN .....	44
SCOPE:SINGLE .....	44
SCOPE:STOP .....	44
SCOPE:TIMEbase:SCALE <NRf> .....	44
SCOPE:VOLTagE:SCALE <NRf> .....	45
SCOPE:CURREnt:SCALE <NRf> .....	45
SCOPE:TIMEbase:DELay <NRf> .....	46
SCOPE:TRIGger:SOURce .....	46
SCOPE:TRIGger:LEVel <NRf> .....	46
SCOPE:TRIGger:SLOPe <CPD> .....	47
SCOPE:TRIGger:MODE <CPD> .....	47
SCOPE:LINE:SElection .....	48
SCOPE:STATus? .....	48
SCOPE:RSTate? .....	48
SCOPE:WAVEform:DATA? .....	49

SCOPE:RANGe:CATalog?	49
SCOPE:RECOrd:LENGth <0.6 6 60 600>	49
SCOPE:SAMPle:MODE <NORMal PEAK>	49
SCOPE:DATA:TAG?	50
SCOPE:PRINt:TYPE <OFF POST RAW BOTH>	50
<b>Chapter12      SOURce Subsystem (Source)</b>	<b>52</b>
[SOURce:]FUNCTion <CPD1>[,CPD2]	52
[SOURce:]FUNCTion:MODE <CPD>	52
[SOURce:]CURRent:PROTEction:RMS <NRf+> [,CH1 CH2 CH3]	53
[SOURce:]CURRent:PROTEction:DELAy <NRf+> [,CH1 CH2 CH3]	53
[SOURce:]CURRent:PROTEction:DELAy? [CH1 CH2 CH3],[MAXimum MINimum DEFault]	54
[SOURce:]CURRent:PROTEction:MODE <CPD> [,CH1 CH2 CH3]	54
[SOURce:]CURRent:PROTEction:PEAK <NRf+> [,CH1 CH2 CH3]	55
[SOURce:]CURRent:PROTEction:PEAK? [CH1 CH2 CH3],[MAXimum MINimum DEFault]	55
[SOURce:]CURRent:PROTEction:PEAK:DELAy<NRf+> [,CH1 CH2 CH3]	55
[SOURce:]CURRent:PROTEction:PEAK:DELAy? [CH1 CH2 CH3],[MAXimum MINimum DEFault]	56
[SOURce:]CURRent:LIMit:HIGH <NRf+> [,CH1 CH2 CH3]	56
[SOURce:]CURRent:LIMit:LOW <NRf+> [,CH1 CH2 CH3]	57
[SOURce:]CURRent[:LEVel][:IMMEDIATE][:AMPLitude][:AC] <NRf+>[,NRf+][,NRf+]	57
[SOURce:]CURRent[:LEVel][:IMMEDIATE][:AMPLitude]:DC <NRf+>[,NRf+][,NRf+]	58
[SOURce:]VOLTage[:LEVel][:IMMEDIATE][:AMPLitude][:AC] <NRf+>[,NRf+][,NRf+]	58
[SOURce:]VOLTage:LIMit:HIGH <NRf+> [,CH1 CH2 CH3]	59
[SOURce:]VOLTage:LIMit:LOW <NRf+> [,CH1 CH2 CH3]	59
[SOURce:]PVOLTage[:LEVel][:IMMEDIATE][:AMPLitude][:AC] <phase>,<NRf+>	60
[SOURce:]VOLTage[:LEVel][:IMMEDIATE][:AMPLitude]:DC <NRf+>[,NRf+][,NRf+]	60
[SOURce:]PVOLTage[:LEVel][:IMMEDIATE][:AMPLitude]:DC <phase>,<NRf+>	61
[SOURce:]VOLTage:SLOPe[:AC][:IMMEDIATE] <NRf+>[,NRf+][,NRf+]	61
[SOURce:]PVOLTage:SLOPe[:IMMEDIATE][:AC] <phase>,<NRf+>	62
[SOURce:]VOLTage:SLOPe[:IMMEDIATE]:DC <NRf+>[,NRf+][,NRf+]	62
[SOURce:]PVOLTage:SLOPe[:IMMEDIATE]:DC <phase>,<NRf+>	62
[SOURce:]FREQuency[:IMMEDIATE] <NRf+>[,NRf+][,NRf+]	63
[SOURce:]PFREQuency[:IMMEDIATE] <phase>,<NRf+>	63
[SOURce:]FREQuency:SLOPe[:IMMEDIATE] <NRf+>[,NRf+][,NRf+]	64
[SOURce:]PFREQuency:SLOPe[:IMMEDIATE] <phase>,<NRf+>	64
[SOURce:]POWEr:LIMit:HIGH <NRf+> [,CH1 CH2 CH3]	65
[SOURce:]POWEr:LIMit:LOW <NRf+> [,CH1 CH2 CH3]	65
[SOURce:]POWEr:LIMit:DELAy <NRf+> [,CH1 CH2 CH3]	65
[SOURce:]ANGLe:DIFFerence[:IMMEDIATE] <type>,<NRf+>	66
[SOURce:]WAVE[:IMMEDIATE] <wave>,[wave],[wave]	66
[SOURce:]PWAVE[:IMMEDIATE] <phase>,<wave>	67
[SOURce:]DIMMing[:STATe] <CPD>[,CH1 CH2 CH3]	67
[SOURce:]DIMMing:EDGE <CPD>[,CH1 CH2 CH3]	68
[SOURce:]DIMMing:PHASe <NRf+>[,CH1 CH2 CH3]	68
[SOURce:]EXTErn:PROGrama[:STATe] <CPD>	68
[SOURce:]EXTErn:PROGrama:MODE <CPD>	69
[SOURce:]EXTErn:MONitor:PHASe <phase>	69
[SOURce:]EXTErn:PROGrama:VOLTage:RANGe <range>	69
[SOURce:]CONFIgure:HARMonic:THD:FORMula <CPD>	70
[SOURce:]CONFIgure:HARMonic:TABLE:TYPE <CPD>	70
[SOURce:]CONFIgure:HARMonic:TABLE:SELEct <CPD>	71
[SOURce:]CONFIgure:HARMonic:TABLE:PHASe[:MODE] <CPD>	71
[SOURce:]VOLTage:PROTEction:PEAK <NRf+> [A B C CH1 CH2 CH3]	71
[SOURce:]VOLTage:PROTEction:DELAy <NRf+> [A B C CH1 CH2 CH3]	72
[SOURce:]CURRent:INRush:MODE <CPD>	72
[SOURce:]CURRent:INRush:DELAy <NRf+>	72
[SOURce:]CURRent:INRush:HOLD <NRf+>	73
[SOURce:]VOLTage:LINE:MODE <mode>	73
[SOURce:]VOLTage:LINE:VAB <value>	73
[SOURce:]VOLTage:LINE:VBC <value>	74

[SOURce:]VOLTage:LINE:VCA <value> .....	74
[SOURce:]VOLTage:LINE:APPLY:APPRoximate .....	74
<b>Chapter13      Output Commands (Source) .....</b>	<b>76</b>
OUTPut[:STATe] <CPD> .....	76
OUTPut:PROTection:CLear .....	76
OUTPut:PROTection:WDOG[:STATe] <CPD> .....	76
OUTPut:PROTection:WDOG:DELay <NRf+> .....	77
OUTPut:IMPedance[:STATe] <CPD>[,A B C CH1 CH2 CH3] .....	77
OUTPut:IMPedance:RESistance:LEVel <NRf+>[,A B C CH1 CH2 CH3] .....	77
OUTPut:IMPedance:INDuctance:LEVel <NRf+>[,A B C CH1 CH2 CH3] .....	78
OUTPut:OFF:MODE <CPD> .....	78
OUTPut:SHORT:DELay <NRf+> .....	79
OUTPut:ON:PHASe:MODE <CPD> .....	79
OUTPut:ON:PHASe:LEVel <NRf+> .....	80
OUTPut:ON:SLOPe:LEVel <NRf+> .....	80
OUTPut:OFF:SLOPe:LEVel <NRf+> .....	81
OUTPut:OFF:PHASe:MODE <CPD> .....	81
OUTPut:OFF:PHASe:LEVel <NRf+> .....	82
OUTPut:BALance[:STATe] <CPD> .....	82
<b>Chapter14      SENSE Commands (Source).....</b>	<b>83</b>
SENSe[:REMote][:STATe] <CPD> .....	83
SENSe:FILTer[:STATe] <CPD> .....	83
SENSe:FILTer:LEVel <CPD> .....	83
SENSe:LOOP:SPEEd <CPD> .....	84
SENSe:EXTernal:FREQuency <CPD> [CH1, CH2, CH3] .....	84
SENSe:EXTernal:FREQuency:OFFSet:HIGH <NRf>[,CH1, CH2, CH3] .....	85
SENSe:EXTernal:FREQuency:OFFSet:LOW <NRf>[,CH1, CH2, CH3] .....	85
SENSe:EXTernal:FREQuency:PHASe <NRf>[,CH1, CH2, CH3] .....	86
SENSe:EXTernal:FREQuency:EXCeption <CPD>[,CH1, CH2, CH3] .....	86
SENSe:EXTernal:FREQuency:SYNC <CPD> .....	87
<b>Chapter15      FETCH &amp; MEASURE Commands (Source) .....</b>	<b>88</b>
FETCh[:SCALar]:CURRent[:AC]? .....	88
MEASure[:SCALar]:CURRent[:AC]? .....	88
FETCh[:SCALar]:CURRent:DC? .....	88
MEASure[:SCALar]:CURRent:DC? .....	88
FETCh[:SCALar]:CURRent:AMPlitude:MAXimum:POSitive? .....	89
MEASure[:SCALar]:CURRent:AMPlitude:MAXimum:POSitive? .....	89
FETCh[:SCALar]:CURRent:AMPlitude:MAXimum:NEGative? .....	89
MEASure[:SCALar]:CURRent:AMPlitude:MAXimum:NEGative? .....	89
FETCh[:SCALar]:CURRent:AMPlitude:MAXimum? .....	89
MEASure[:SCALar]:CURRent:AMPlitude:MAXimum? .....	89
FETCh[:SCALar]:CURRent:CFACtor? .....	90
MEASure [:SCALar]:CURRent:CFACtor? .....	90
FETCh[:SCALar]:FREQuency? .....	90
MEASure[:SCALar]:FREQuency? .....	90
FETCh[:SCALar]:POWER[:REAL]? .....	91
MEASure[:SCALar]:POWER[:REAL]? .....	91
FETCh[:SCALar]:POWER:APParent? .....	91
MEASure[:SCALar]:POWER:APParent? .....	91
FETCh[:SCALar]:POWER:REACTive? .....	92
MEASure[:SCALar]:POWER:REACTive? .....	92
FETCh[:SCALar]:POWER:PFACtor? .....	92
MEASure[:SCALar]:POWER:PFACtor? .....	92
FETCh[:SCALar]:VOLTage[:AC]? .....	93
MEASure[:SCALar]:VOLTage[:AC]? .....	93
FETCh[:SCALar]:VOLTage:DC? .....	93
MEASure[:SCALar]:VOLTage:DC? .....	93

FETCh[:SCALar]:VOLTagE:AMPliTude:MAXimum?	93
MEASure[:SCALar]:VOLTagE:AMPliTude:MAXimum?	93
FETCh[:SCALar]:VOLTagE:AMPliTude:MAXimum:POSitive?	94
MEASure[:SCALar]:VOLTagE:AMPliTude:MAXimum:POSitive?	94
FETCh[:SCALar]:VOLTagE:AMPliTude:MAXimum:NEGative?	94
MEASure[:SCALar]:VOLTagE:AMPliTude:MAXimum:NEGative?	94
FETCh[:SCALar]?	95
MEASure[:SCALar]?	95
FETCh[:SCALar]:POWER[:REAL]:TOTal?	96
MEASure[:SCALar]:POWER[:REAL]:TOTal?	96
FETCh[:SCALar]:POWER:APParent:TOTal?	96
MEASure[:SCALar]:POWER:APParent:TOTal?	96
FETCh[:SCALar]:POWER:REACTive:TOTal?	97
MEASure[:SCALar]:POWER:REACTive:TOTal?	97
FETCh[:SCALar]:LTLVoltage[:AC]?	97
MEASure[:SCALar]:LTLVoltage[:AC]?	97
FETCh[:SCALar]:VOLTagE:HARMonic[:AMPLitude]? <[A B C CH1 CH2 CH3]>,<NR1>	98
MEASure[:SCALar]:VOLTagE:HARMonic[:AMPLitude]? <[A B C CH1 CH2 CH3]>,<NR1>	98
FETCh[:SCALar]:CURRent:HARMonic[:AMPLitude]? <[A B C CH1 CH2 CH3]>,<NR1>	98
MEASure[:SCALar]:CURRent:HARMonic[:AMPLitude]? <[A B C CH1 CH2 CH3]>,<NR1>	98
FETCh[:SCALar]:VOLTagE:HARMonic:DISTort? <[A B C CH1 CH2 CH3]>,<NR1>	99
MEASure[:SCALar]:VOLTagE:HARMonic:DISTort? <[A B C CH1 CH2 CH3]>,<NR1>	99
FETCh[:SCALar]:CURRent:HARMonic:DISTort? <[A B C CH1 CH2 CH3]>,<NR1>	99
MEASure[:SCALar]:CURRent:HARMonic:DISTort? <[A B C CH1 CH2 CH3]>,<NR1>	99
FETCh[:SCALar]:VOLTagE:HARMonic:PHASe? <[A B C CH1 CH2 CH3]>,<NR1>	100
MEASure[:SCALar]:VOLTagE:HARMonic:PHASe? <[A B C CH1 CH2 CH3]>,<NR1>	100
FETCh[:SCALar]:CURRent:HARMonic:PHASe? <[A B C CH1 CH2 CH3]>,<NR1>	100
MEASure[:SCALar]:CURRent:HARMonic:PHASe? <[A B C CH1 CH2 CH3]>,<NR1>	100
FETCh[:SCALar]:VOLTagE:HARMonic:THD? <[A B C CH1 CH2 CH3]>	101
MEASure[:SCALar]:VOLTagE:HARMonic:THD? <[A B C CH1 CH2 CH3]>	101
FETCh[:SCALar]:CURRent:HARMonic:THD? <[A B C CH1 CH2 CH3]>	101
MEASure[:SCALar]:CURRent:HARMonic:THD? <[A B C CH1 CH2 CH3]>	101
FETCh[:SCALar]:ARRay:VOLTagE:HARMonic[:AMPLitude]? <[A B C CH1 CH2 CH3]>,<NR1>	102
MEASure[:SCALar]:ARRay:VOLTagE:HARMonic[:AMPLitude]? <[A B C CH1 CH2 CH3]>,<NR1>	102
FETCh[:SCALar]:ARRay:CURRent:HARMonic[:AMPLitude]? <[A B C CH1 CH2 CH3]>,<NR1>	102
MEASure[:SCALar]:ARRay:CURRent:HARMonic[:AMPLitude]? <[A B C CH1 CH2 CH3]>,<NR1>	102
FETCh[:SCALar]:ARRay:VOLTagE:HARMonic:PHASe? <[A B C CH1 CH2 CH3]>,<NR1>	103
MEASure[:SCALar]:ARRay:VOLTagE:HARMonic:PHASe? <[A B C CH1 CH2 CH3]>,<NR1>	103
FETCh[:SCALar]:ARRay:CURRent:HARMonic:PHASe? <[A B C CH1 CH2 CH3]>,<NR1>	103
MEASure[:SCALar]:ARRay:CURRent:HARMonic:PHASe? <[A B C CH1 CH2 CH3]>,<NR1>	103
FETCh[:SCALar]:ARRay:VOLTagE:HARMonic:DISTort? <[A B C CH1 CH2 CH3]>,<NR1>	104
MEASure[:SCALar]:ARRay:VOLTagE:HARMonic:DISTort? <[A B C CH1 CH2 CH3]>,<NR1>	104
FETCh[:SCALar]:ARRay:CURRent:HARMonic:DISTort? <[A B C CH1 CH2 CH3]>,<NR1>	104
MEASure[:SCALar]:ARRay:CURRent:HARMonic:DISTort? <[A B C CH1 CH2 CH3]>,<NR1>	104
FETCh[:SCALar]:WHOUr[:ACTive][:SUM]?	105
FETCh[:SCALar]:WHOUr[:ACTive]:POSitive?	105
FETCh[:SCALar]:WHOUr[:ACTive]:NEGative?	105
FETCh[:SCALar]:AHOuR[:ACTive][:SUM]?	105
FETCh[:SCALar]:AHOuR[:ACTive]:POSitive?	106
FETCh[:SCALar]:AHOuR[:ACTive]:NEGative?	106
FETCh[:SCALar]:ENERgy:TIME?	106
VETCor:OEDer <NR1>	106
MEASure[:SCALar]:VECTor:DATA?	107
FETCh[:SCALar]:VECTor:DATA?	107
MEASure[:SCALar]:VECTor:TYPE <CPD>	107
FETCh[:SCALar]:VECTor:TYPE <CPD>	107
VETCor:DATA?	108
VETCor:TYPE <CPD>	108
<b>Chapter16 ARB Subsystem (Source)</b>	<b>109</b>

[ARB:]LIST:STATe?	109
[ARB:]LIST:REPeat <NR1>	109
[ARB:]LIST:TERMinate <CPD>	109
[ARB:]LIST:RUNTime:STATe?	110
[ARB:]LIST:RCL <string>	110
[ARB:]LIST:STEP:COUnT <NR1>	110
[ARB:]LIST:CLEar	111
[ARB:]LIST:STEP <NR1>,<string>	111
[ARB:]LIST:STEP:ITEM <NR1>,<NR2>,<string>	113
[ARB:]LIST:STEP:ITEM? <NR1>,<item>	114
[ARB:]LIST:NAME?	115
[ARB:]LIST:SAVe <filename>	115
[ARB:]LIST:CONFigure	115
[ARB:]LIST:CREate	115
[ARB:]LIST:FILE:NUMBer?	116
[ARB:]LIST:FILE:NAME? <index>	116
[ARB:]LIST:FILE:DELeTe <filename>	116
[ARB:]LIST:STEP:DELeTe <NR1>	116
[ARB:]LIST:STEP:EDIT <NR1>,<string>	117
LIST:STEP:JUMP <NR1>	117
<b>Chapter17 SWEep Subsystem (Source)</b>	<b>118</b>
SWEep:VOLTage:STARt <NRf+>[,<NRf+>,<NRf+>]	118
SWEep:VOLTage:STOP <NRf+>[,<NRf+>,<NRf+>]	118
SWEep:VOLTage:STEP <NRf+>[,<NRf+>,<NRf+>]	119
SWEep:FREQ:STARt <NRf+>[,<NRf+>,<NRf+>]	119
SWEep:FREQ:STOP <NRf+>[,<NRf+>,<NRf+>]	120
SWEep:FREQ:STEP <NRf+>[,<NRf+>,<NRf+>]	121
SWEep:TIME:STEP <NRf+>[,<NRf+>,<NRf+>]	121
SWEep:MODE <mode>	122
SWEep:PRiority<priority>	122
SWEep:WAVEform <type>,<NR1>	123
SWEep:FINish <mode>	124
SWEep:TRIG:SOURce <mode>	124
SWEep:STEP:REPeat <NR1>	125
SWEep:SAVe <string>	125
SWEep:RECall <string>	125
SWEep:STATe?	126
<b>Chapter18 SURGesag Subsystem (Source)</b>	<b>127</b>
SURGesag:MODE <mode>	127
SURGesag:PHASe:STARt <NRf+>	127
SURGesag:PHASe:WIDTh <NRf+>	128
SURGesag:ACTion <action>	128
SURGesag:TRIG:SOURce <source>	129
SURGesag:SYMMetry <bool>	129
SURGesag:REPeat:COUnT <NR1>	130
SURGesag:PERiod:COUnT <NR1>	130
SURGesag:VALue:SElect <mode>	131
SURGesag:VALue:PERCent <NRf+>	131
SURGesag:VALue <NRf+>	132
SURGesag:PHASe:ENABLE <A B C AB AC BC ABC>	132
SURGesag:ANGLE:ENABLE <SYNC SPEC>	133
SURGesag:SAVe <string>	133
SURGesag:RECall <string>	134
SURGesag:STATe?	134
<b>Chapter19 SCOPe Subsystem (Source)</b>	<b>135</b>
SCOPe:AUTO	135
SCOPe:RUN	135

SCOPE:SINGLE .....	135
SCOPE:STOP .....	135
SCOPE:TIMEbase:SCALE <NRf> .....	135
SCOPE:VOLTage:SCALE <NRf>.....	136
SCOPE:CURRent:SCALE <NRf>.....	136
SCOPE:TIMEbase:DElay <NRf> .....	137
SCOPE:TRIGger:SOURce .....	137
SCOPE:TRIGger:LEVel <NRf>.....	137
SCOPE:TRIGger:SLOPe <CPD>.....	138
SCOPE:TRIGger:MODE <CPD> .....	138
SCOPE:LINE:SElection .....	139
SCOPE:STATus? .....	139
SCOPE:RSTate? .....	139
SCOPE:WAVEform:DATA? .....	140
SCOPE:RANGe:CATalog? .....	140
SCOPE:RECORD:LENGth <0.6 6 60 600>.....	140
SCOPE:SAMPle:MODE <NORMal PEAK> .....	140
SCOPE:DATA:TAG? .....	141
<b>Chapter20      WAVEform Subsystem (Source) .....</b>	<b>142</b>
WAVEform[:IMMediate] <WAVEform>,[WAVEform],[WAVEform] .....	142
PWAVEform[:IMMediate] <phase/chan>,<WAVEform>.....	142
WAVEform:EDIT:PARAmeter <phase/chan>,<percent1> .....	143
WAVEform:EDIT:THD:CLEar .....	143
WAVEform:EDIT:THD:IMPort <filename>.....	144
WAVEform:EDIT:THD:FORMula <formula>.....	144
WAVEform:EDIT:THD:FUNDamental:PHASe <phase> .....	144
WAVEform:EDIT:THD:DATA <order>,<string> .....	145
WAVEform:EDIT:THD:SAVE:LOCAl <filename>.....	145
WAVEform:EDIT:THD:SAVE:UDISK <filename> .....	146
WAVEform:EDIT:THD:DElete <filename>.....	146
WAVEform:EDIT:THD:FILE:NUMBer?.....	146
WAVEform:EDIT:THD:FILE:NAME? <index>.....	146
WAVEform:EDIT:USERdefine:CLEar .....	147
WAVEform:EDIT:USERdefine:IMPort <filename> .....	147
WAVEform:EDIT:USERdefine:MODE <symmtery>.....	147
WAVEform:EDIT:USERdefine:DATA <index>,<normalization> .....	148
WAVEform:EDIT:USERdefine:SAVE:LOCAl <filename>.....	148
WAVEform:EDIT:USERdefine:SAVE:UDISK <filename> .....	149
WAVEform:EDIT:USERdefine:DElete <filename> .....	149
WAVEform:EDIT:USERdefine:FILE:NUMBer? .....	149
WAVEform:EDIT:USERdefine:FILE:NAME? <index> .....	149
<b>Chapter21      ISLand Subsystem (Source).....</b>	<b>151</b>
ISLand:RUN:STATe?.....	151
ISLand:TIME?.....	151
ISLand:KEY1[:STATe] <CPD> .....	151
ISLand:KEY2:STATe] <CPD> .....	152
ISLand:RESistance:LEVel <NRf+>,[A B C] .....	152
ISLand:INDucatance:LEVel <NRf+>,[A B C] .....	153
ISLand:PHASe:LEVel <NRf+>,[A B C] .....	153
ISLand:CAP:LEVel <NRf+>,[A B C] .....	153
ISLand:POWER:LEVel <NRf+>,[A B C] .....	154
ISLand:QL:LEVel <NRf+>,[A B C] .....	154
ISLand:QC:LEVel <NRf+>,[A B C] .....	155
ISLand:MODE <CPD>,[CH1 CH2 CH3].....	155
ISLand:INHibit[:STATe] <CPD>.....	155
ISLand:VOLTage:CONTRol[:STATe] <CPD>,[CH1 CH2 CH3] .....	156
ISLand:VOLTage:CONTRol:LEVel <NRf+>,[A B C CH1 CH2 CH3] .....	156
ISLand:CURRent:CONTRol[:STATe] <CPD>,[CH1 CH2 CH3] .....	157

ISLand:CURRent:CONTRol:LEVel <NRF+>[,A B C CH1 CH2 CH3] .....	157
ISLand:POWer:CONTRol[:STATe] <CPD>[,CH1 CH2 CH3] .....	158
ISLand:POWer:CONTRol:LEVel <NRF+>[,A B C CH1 CH2 CH3] .....	158
<b>Chapter22 Current Source Subsystem .....</b>	<b>159</b>
[SOURce:]DIMMing[:STATe] <CPD>[,CH1 CH2 CH3] .....	161
[SOURce:]DIMMing:EDGE <CPD>[,CH1 CH2 CH3] .....	162
[SOURce:]DIMMing:PHASe <NRF+>[,CH1 CH2 CH3] .....	162
[SOURce:]EXTErn:PROGAm[:STATe] <CPD> .....	163
[SOURce:]EXTErn:PROGAm:MODE <CPD> .....	163
[SOURce:]EXTErn:MONitor:PHASe <phase> .....	163
[SOURce:]EXTErn:PROGAm:VOLTage:RANGe <range> .....	164
[SOURce:]EXTErn:PROGAm:CURRent:RANGe <range> .....	164
[SOURce:]EXTErn:PROGAm:VOLTage:SELf <NRF+> .....	164
[SOURce:]CONFIgure:HARMonic:THD:FORMula <CPD> .....	165
[SOURce:]CONFIgure:HARMonic:TABLE:TYPE <CPD> .....	165
[SOURce:]CONFIgure:HARMonic:TABLE:SElect <CPD> .....	166
[SOURce:]FUNCTion <CPD1> .....	166
[SOURce:]CURRent:LIMit:HIGH <NRF+> .....	166
[SOURce:]CURRent:LIMit:LOW <NRF+> .....	167
[SOURce:]CURRent:LIMit:DELay <NRF+> .....	167
[SOURce:]CURRent:LIMit:DELay <NRF+> .....	168
[SOURce:]VOLTage:LIMit:HIGH <NRF+> .....	168
[SOURce:]VOLTage:LIMit:LOW <NRF+> .....	168
[SOURce:]POWer:LIMit:HIGH <NRF+> .....	169
[SOURce:]POWer:LIMit:LOW <NRF+> .....	169
[SOURce:]POWer:LIMit:DELay <NRF+> .....	169
<b>Chapter23 Current OUTPut Subsystem .....</b>	<b>171</b>
[SOURce:]CURRent:OUTPut[:STATe] <state> .....	171
[SOURce:]CURRent:OUTPut:PROTEction:CLEar .....	171
[SOURce:]CURRent:OUTPut:OFF:MODE <CPD> .....	171
[SOURce:]CURRent:OUTPut:ON:PHASe:MODE <CPD> .....	172
[SOURce:]CURRent:OUTPut:ON:PHASe:LEVel <NRF+> .....	172
[SOURce:]CURRent:OUTPut:OFF:PHASe:MODE <CPD> .....	173
[SOURce:]CURRent:OUTPut:OFF:PHASe:LEVel <NRF+> .....	173
[SOURce:]CURRent:OUTPut:ALC[:STATe] <CPD> .....	174
<b>Chapter24 Current Fetch/Measure Subsystem .....</b>	<b>175</b>
FETCh[:SCALar]:CURRent[:AC]? .....	175
MEASure[:SCALar]:CURRent[:AC]? .....	175
FETCh[:SCALar]:CURRent:DC? .....	175
MEASure[:SCALar]:CURRent:DC? .....	175
FETCh[:SCALar]:CURRent:AMPlitude:MAXimum:POSitive? .....	175
MEASure[:SCALar]:CURRent:AMPlitude:MAXimum:POSitive? .....	175
FETCh[:SCALar]:CURRent:AMPlitude:MAXimum:NEGative? .....	176
MEASure[:SCALar]:CURRent:AMPlitude:MAXimum:NEGative? .....	176
FETCh[:SCALar]:CURRent:AMPlitude:MAXimum? .....	176
MEASure[:SCALar]:CURRent:AMPlitude:MAXimum? .....	176
FETCh[:SCALar]:CURRent:AMPlitude:MAXimum:HOLD? .....	177
MEASure[:SCALar]:CURRent:AMPlitude:MAXimum:HOLD? .....	177
FETCh[:SCALar]:CURRent:CFActor? .....	177
MEASure[:SCALar]:CURRent:CFActor? .....	177
FETCh[:SCALar]:FREQuency? .....	177
MEASure[:SCALar]:FREQuency? .....	177
FETCh[:SCALar]:POWer[:REAL]? .....	178
MEASure[:SCALar]:POWer[:REAL]? .....	178
FETCh[:SCALar]:POWer:APParent? .....	178
MEASure[:SCALar]:POWer:APParent? .....	178
FETCh[:SCALar]:POWer:REACTive? .....	178

MEASure[:SCALar]:POWER:REACTIVE?	178
FETCh[:SCALar]:POWER:PFACTOR?	179
MEASure[:SCALar]:POWER:PFACTOR?	179
FETCh[:SCALar]:VOLTage[:AC]?	179
MEASure[:SCALar]:VOLTage[:AC]?	179
FETCh[:SCALar]:VOLTage:DC?	180
MEASure[:SCALar]:VOLTage:DC?	180
FETCh[:SCALar]:VOLTage:AMPLitude:MAXimum?	180
MEASure[:SCALar]:VOLTage:AMPLitude:MAXimum?	180
FETCh[:SCALar]:VOLTage:AMPLitude:MAXimum:POSitive?	180
MEASure[:SCALar]:VOLTage:AMPLitude:MAXimum:POSitive?	180
FETCh[:SCALar]:VOLTage:AMPLitude:MAXimum:NEGative?	181
MEASure[:SCALar]:VOLTage:AMPLitude:MAXimum:NEGative?	181
FETCh[:SCALar]:VOLTage[:AC][:AMPLitude]:MAXimum:HOLD? [A]	181
MEASure[:SCALar]:VOLTage[:AC][:AMPLitude]:MAXimum:HOLD? [A]	181
FETCh[:SCALar]:VOLTage[:AC][:AMPLitude]:MAXimum:HOLD:CLEar [A]	181
MEASure[:SCALar]:VOLTage[:AC][:AMPLitude]:MAXimum:HOLD:CLEar [A]	181
FETCh[:SCALar]?	182
MEASure[:SCALar]?	182
FETCh[:SCALar]:VOLTage:HARMonic[:AMPLitude]? <NR1>	182
MEASure[:SCALar]:VOLTage:HARMonic[:AMPLitude]? <NR1>	182
FETCh[:SCALar]:CURRent:HARMonic[:AMPLitude]? <NR1>	183
MEASure[:SCALar]:CURRent:HARMonic[:AMPLitude]? <NR1>	183
FETCh[:SCALar]:VOLTage:HARMonic:DISTort? <NR1>	183
MEASure[:SCALar]:VOLTage:HARMonic:DISTort? <NR1>	183
FETCh[:SCALar]:CURRent:HARMonic:DISTort? <NR1>	184
MEASure[:SCALar]:CURRent:HARMonic:DISTort? <NR1>	184
FETCh[:SCALar]:VOLTage:HARMonic:PHASe? <NR1>	184
MEASure[:SCALar]:VOLTage:HARMonic:PHASe? <NR1>	184
FETCh[:SCALar]:CURRent:HARMonic:PHASe? <NR1>	184
MEASure[:SCALar]:CURRent:HARMonic:PHASe? <NR1>	184
FETCh[:SCALar]:VOLTage:HARMonic:THD?	185
MEASure[:SCALar]:VOLTage:HARMonic:THD?	185
FETCh[:SCALar]:CURRent:HARMonic:THD?	185
MEASure[:SCALar]:CURRent:HARMonic:THD?	185
FETCh[:SCALar]:ARRay:VOLTage:HARMonic[:AMPLitude]? <NR1>	186
MEASure[:SCALar]:ARRay:VOLTage:HARMonic[:AMPLitude]? <NR1>	186
FETCh[:SCALar]:ARRay:CURRent:HARMonic[:AMPLitude]? <NR1>	186
MEASure[:SCALar]:ARRay:CURRent:HARMonic[:AMPLitude]? <NR1>	186
FETCh[:SCALar]:ARRay:VOLTage:HARMonic:PHASe? <NR1>	187
MEASure[:SCALar]:ARRay:VOLTage:HARMonic:PHASe? <NR1>	187
FETCh[:SCALar]:ARRay:CURRent:HARMonic:PHASe? <NR1>	187
MEASure[:SCALar]:ARRay:CURRent:HARMonic:PHASe? <NR1>	187
FETCh[:SCALar]:ARRay:VOLTage:HARMonic:DISTort? <NR1>	188
MEASure[:SCALar]:ARRay:VOLTage:HARMonic:DISTort? <NR1>	188
FETCh[:SCALar]:ARRay:CURRent:HARMonic:DISTort? <NR1>	188
MEASure[:SCALar]:ARRay:CURRent:HARMonic:DISTort? <NR1>	188
FETCh[:SCALar]:WHOur[:ACTIVE][:SUM]?	188
FETCh[:SCALar]:WHOur[:ACTIVE]:POSitive?	189
FETCh[:SCALar]:WHOur[:ACTIVE]:NEGative?	189
FETCh[:SCALar]:AHOur[:ACTIVE][:SUM]?	189
FETCh[:SCALar]:AHOur[:ACTIVE][:SUM]?	190
FETCh[:SCALar]:AHOur[:ACTIVE]:POSitive?	190
FETCh[:SCALar]:AHOur[:ACTIVE]:NEGative?	190
FETCh[:SCALar]:ENERgy:TIME?	190
<b>Chapter25 Current List Subsystem</b>	<b>192</b>
LIST:STATE?	192
LIST:REPeat <NR1>	192
LIST:TERMinate <CPD>	192

LIST:RUNTime:StAtE?	193
[ARB:]LIST:RCL <string>	193
[ARB:]LIST:STEP:COUnT <NR1>	193
[ARB:]LIST:CLear	194
LIST:STEP <NR1>,<string>	194
LIST:STEP:ITEM <NR1>,<NR1>,<string>	196
LIST:STEP:ITEM? <NR1>,<item>	197
[ARB:]LIST:NAME?	198
[ARB:]LIST:SAVe <filename>	198
[ARB:]LIST:CONFigure	198
[ARB:]LIST:CREate	198
[ARB:]LIST:FILE:NUMBer?	198
[ARB:]LIST:FILE:NAME? <index>	199
[ARB:]LIST:FILE:DELeTe <filename>	199
[ARB:]LIST:STEP:DELeTe <NR1>	199
[ARB:]LIST:STEP:EDIT <NR1>,<string>	199
LIST:STEP:DELeTe <NR1>	200
LIST:STEP:JUMP <NR1>	200
LIST:TRAPezoid:PARAm <NR1>,<CPD>,<NRf+>	201
LIST:CLIPped:PARAm <NR1>,<CPD>,<NRf+>	201
LIST:RECTifier:PARAm <NR1>,<CPD>,<NRf+>	202
<b>Chapter26 Current WAVEform Subsystem</b>	<b>203</b>
WAVEform[:IMMediate] <WAVEform>	203
WAVEform[:IMMediate] <phase/chan>,<WAVEform>	203
WAVEform:EDIT:PARAmeter <phase/chan>,<percent1>	204
WAVEform:EDIT:THD:CLear	205
WAVEform:EDIT:THD:IMPort <filename>	205
WAVEform:EDIT:THD:FORMula <formula>	205
WAVEform:EDIT:THD:FUNDamental:PHASe <phase>	206
WAVEform:EDIT:THD:DATA <order>,<string>	206
WAVEform:EDIT:THD:SAVE:LOCAl <filename>	207
WAVEform:EDIT:THD:SAVE:UDISk <filename>	207
WAVEform:EDIT:THD:DELeTe <filename>	207
WAVEform:EDIT:USERdefine:CLear	207
WAVEform:EDIT:USERdefine:IMPort <filename>	208
WAVEform:EDIT:USERdefine:MODE <symmtery>	208
WAVEform:EDIT:USERdefine:DATA <index>,<normalization>	209
WAVEform:EDIT:USERdefine:SAVE:LOCAl <filename>	209
WAVEform:EDIT:USERdefine:SAVE:UDISk <filename>	209
WAVEform:EDIT:USERdefine:DELeTe <filename>	210
WAVEform:EDIT:THD:FILE:NUMBer?	210
WAVEform:EDIT:THD:FILE:NAME? <index>	210
WAVEform:EDIT:USERdefine:FILE:NUMBer?	210
WAVEform:EDIT:USERdefine:FILE:NAME? <index>	211
<b>Chapter27 Channel Subsystem (Load)</b>	<b>212</b>
<b>Chapter28 FETCh &amp; MEASure Subsystem (Load)</b>	<b>213</b>
FETCh[:SCALar]:CURRent[:AC]?	213
MEASure[:SCALar]:CURRent[:AC]?	213
FETCh[:SCALar]:CURRent:DC?	213
MEASure[:SCALar]:CURRent:DC?	213
FETCh[:SCALar]:CURRent[:AC][:AMPLitude]:MAXimum:POSitive?	214
MEASure[:SCALar]:CURRent[:AC][:AMPLitude]:MAXimum:POSitive?	214
FETCh[:SCALar]:CURRent[:AC][:AMPLitude]:MAXimum:NEGative?	214
MEASure[:SCALar]:CURRent[:AC][:AMPLitude]:MAXimum:NEGative?	214
FETCh[:SCALar]:CURRent[:AC][:AMPLitude]:MAXimum?	215
MEASure[:SCALar]:CURRent[:AC][:AMPLitude]:MAXimum?	215
FETCh[:SCALar]:VOLTage[:AC][:AMPLitude]:MAXimum:HOLD?	215
MEASure[:SCALar]:VOLTage[:AC][:AMPLitude]:MAXimum:HOLD?	215

FETCh[:SCALar]:VOLTage[AC]:AMPLitude:MAXimum:HOLD:CLEar.....	215
MEASure[:SCALar]:VOLTage[AC]:AMPLitude:MAXimum:HOLD:CLEar.....	215
FETCh[:SCALar]:CURRent:CFACtor? .....	216
MEASure[:SCALar]:CURRent:CFACtor? .....	216
FETCh[:SCALar]:FREQuency? .....	216
MEASure[:SCALar]:FREQuency? .....	216
FETCh[:SCALar]:POWer[:REAL]? .....	217
MEASure[:SCALar]:POWer[:REAL]? .....	217
FETCh[:SCALar]:POWer:APParent? .....	217
MEASure[:SCALar]:POWer:APParent? .....	217
FETCh[:SCALar]:POWer:REACTive? .....	218
MEASure[:SCALar]:POWer:REACTive? .....	218
FETCh[:SCALar]:POWer:PFACTOR? .....	218
MEASure[:SCALar]:POWer:PFACTOR? .....	218
FETCh[:SCALar]:VOLTage[AC]? .....	219
MEASure[:SCALar]:VOLTage[AC]? .....	219
FETCh[:SCALar]:VOLTage:DC? .....	219
MEASure[:SCALar]:VOLTage:DC? .....	219
FETCh[:SCALar]:VOLTage[AC]:AMPLitude:MAXimum? .....	220
MEASure[:SCALar]:VOLTage[AC]:AMPLitude:MAXimum? .....	220
FETCh[:SCALar]:VOLTage[AC]:AMPLitude:MAXimum:POSitive? .....	220
MEASure[:SCALar]:VOLTage[AC]:AMPLitude:MAXimum:POSitive? .....	220
FETCh[:SCALar]:VOLTage[AC]:AMPLitude:MAXimum:NEGative? .....	221
MEASure[:SCALar]:VOLTage[AC]:AMPLitude:MAXimum:NEGative? .....	221
FETCh[:SCALar]? .....	221
MEASure[:SCALar]? .....	221
FETCh[:SCALar]:POWer[:REAL]:TOTal? .....	222
MEASure[:SCALar]:POWer[:REAL]:TOTal? .....	222
FETCh[:SCALar]:POWer:APParent:TOTal? .....	222
MEASure[:SCALar]:POWer:APParent:TOTal? .....	222
FETCh[:SCALar]:POWer:REACTive:TOTal? .....	222
MEASure[:SCALar]:POWer:REACTive:TOTal? .....	222
FETCh[:SCALar]:LTLVoltage[AC]? .....	223
MEASure[:SCALar]:LTLVoltage[AC]? .....	223
FETCh[:SCALar]:VOLTage:HARMonic[AMPLitude]? <[A B C]>,<NR1> .....	223
MEASure[:SCALar]:VOLTage:HARMonic[AMPLitude]? <[A B C]>,<NR1> .....	223
FETCh[:SCALar]:CURRent:HARMonic[AMPLitude]? <[A B C CH1 CH2 CH3]>,<NR1> .....	224
MEASure[:SCALar]:CURRent:HARMonic[AMPLitude]? <[A B C CH1 CH2 CH3]>,<NR1> .....	224
FETCh[:SCALar]:VOLTage:HARMonic:DISort? <[A B C]>,<NR1> .....	224
MEASure[:SCALar]:VOLTage:HARMonic:DISort? <[A B C]>,<NR1> .....	224
FETCh[:SCALar]:CURRent:HARMonic:DISort? <[A B C]>,<NR1> .....	225
MEASure[:SCALar]:CURRent:HARMonic:DISort? <[A B C]>,<NR1> .....	225
FETCh[:SCALar]:VOLTage:HARMonic:PHASe? <[A B C]>,<NR1> .....	225
MEASure[:SCALar]:VOLTage:HARMonic:PHASe? <[A B C]>,<NR1> .....	225
FETCh[:SCALar]:CURRent:HARMonic:PHASe? <[A B C]>,<NR1> .....	226
MEASure[:SCALar]:CURRent:HARMonic:PHASe? <[A B C]>,<NR1> .....	226
FETCh[:SCALar]:VOLTage:HARMonic:THD? <[A B C]> .....	226
MEASure[:SCALar]:VOLTage:HARMonic:THD? <[A B C]> .....	226
FETCh[:SCALar]:CURRent:HARMonic:THD? <[A B C]> .....	227
MEASure[:SCALar]:CURRent:HARMonic:THD? <[A B C]> .....	227
FETCh[:SCALar]:ARRay:VOLTage:HARMonic[AMPLitude]? <[A B C]>,<NR1> .....	227
MEASure[:SCALar]:ARRay:VOLTage:HARMonic[AMPLitude]? <[A B C]>,<NR1> .....	227
FETCh[:SCALar]:ARRay:CURRent:HARMonic[AMPLitude]? <[A B C]>,<NR1> .....	228
MEASure[:SCALar]:ARRay:CURRent:HARMonic[AMPLitude]? <[A B C]>,<NR1> .....	228
FETCh[:SCALar]:ARRay:VOLTage:HARMonic:PHASe? <[A B C]>,<NR1> .....	228
MEASure[:SCALar]:ARRay:VOLTage:HARMonic:PHASe? <[A B C]>,<NR1> .....	228
FETCh[:SCALar]:ARRay:CURRent:HARMonic:PHASe? <[A B C]>,<NR1> .....	229
MEASure[:SCALar]:ARRay:CURRent:HARMonic:PHASe? <[A B C]>,<NR1> .....	229
FETCh[:SCALar]:ARRay:VOLTage:HARMonic:DISort? <[A B C CH1 CH2 CH3]>,<NR1> .....	229
MEASure[:SCALar]:ARRay:VOLTage:HARMonic:DISort? <[A B C CH1 CH2 CH3]>,<NR1> .....	229

FETCh[:SCALar]:ARRay:CURRent:HARMonic:DISort? <[A B C CH1 CH2 CH3]>,<NR1> .....	230
MEASure[:SCALar]:ARRay:CURRent:HARMonic:DISort? <[A B C CH1 CH2 CH3]>,<NR1> .....	230
VETCor:OEDer <NR1> .....	230
VETCor:DATA? .....	231
VETCor:TYPE <CPD> .....	231
<b>Chapter29      SENSE Subsystem (Load).....</b>	<b>232</b>
SENSe[:REMOte][:STATe] <CPD> .....	232
SENSe:FILTer[:STATe] <CPD> .....	232
SENSe:FILTer:LEVel <CPD> .....	232
SENSe:EXTernal:SYNc[:STATe] <boolean> .....	233
SENSe:EXTernal:SYNc:PHASe <NRf> .....	233
SENSe:EXTernal:SYNc:DIFFerence <CPD>,<NRf> .....	234
<b>Chapter30      Load Protect Subsystem (Load).....</b>	<b>235</b>
[SOURce:]CURRent:PROTection:STATe <Boolean> .....	235
[SOURce:]CURRent:PROTection[:LEVel] <NRf+>.....	235
[SOURce:]CURRent:PROTection:DELay <NRf+> .....	236
[SOURce:]CURRent:PEAK:PROTection[:LEVel] <NRf+> .....	237
[SOURce:]CURRent:PEAK:PROTection:DELay <NRf+>.....	237
[SOURce:]POWer:PROTection:STATe <Boolean> .....	237
[SOURce:]POWer:PROTection[:LEVel] <NRf+> .....	238
[SOURce:]POWer:PROTection:DELay <NRf+>.....	238
[SOURce:]VOLTagE:UNDer:PROTection:STATe <Boolean> .....	239
[SOURce:]VOLTagE:UNDer:PROTection[:LEVel] <NRf+> .....	239
[SOURce:]VOLTagE:UNDer:PROTection:DELay <NRf+>.....	239
[SOURce:]VOLTagE:PEAK:PROTection[:LEVel] <NRf+> .....	240
[SOURce:]VOLTagE:PEAK:PROTection:DELay <NRf+> .....	240
[SOURce:]UUT:ABNormal:PROTection:STATe <Boolean> .....	241
[SOURce:]UUT:ABNormal:PROTection:MODE <CPD> .....	241
[SOURce:]FREQuency:PROTection:UPPer <NRf+>.....	241
[SOURce:]FREQuency:PROTection:LOWer <NRf+>.....	242
<b>Chapter31      SOURce Subsystem (Load) .....</b>	<b>243</b>
[SOURce:]FUNcTION <CPD1> .....	243
[SOURce:]FUNcTION:CATalog? .....	244
[SOURce:]UPFactor[:STATe] <Boolean>.....	244
[SOURce:]CURRent[:LEVel][:IMMEdiate][:AMPLitude][:AC] <NRf+>,[NRf+],[NRf+] .....	244
[SOURce:]CURRent[:LEVel][:IMMEdiate][:AMPLitude]:DC <NRf+>,[NRf+],[NRf+] .....	245
[SOURce:]CURRent:SLEW[:AC] <NRf+>,[NRf+],[NRf+] .....	245
[SOURce:]CURRent:SLEW:DC <NRf+> .....	245
[SOURce:]RESistance[:LEVel][:IMMEdiate][:AMPLitude] <NRf+>,[NRf+],[NRf+].....	246
[SOURce:]POWer[:LEVel][:IMMEdiate][:AMPLitude] <NRf+>,[NRf+],[NRf+].....	246
[SOURce:]KVA[:LEVel][:IMMEdiate][:AMPLitude] <NRf+>,[NRf+],[NRf+] .....	247
[SOURce:]PShift[:LEVel][:IMMEdiate][:AMPLitude] <NRf+>,[NRf+],[NRf+] .....	247
[SOURce:]CFACtor[:LEVel][:IMMEdiate][:AMPLitude] <NRf+>,[NRf+],[NRf+] .....	247
[SOURce:]VOLTagE[:LEVel][:IMMEdiate][:AMPLitude] <NRf+> .....	248
[SOURce:]CE:PEAK:CURRent <NRf+>,[NRf+],[NRf+] .....	248
[SOURce:]CE:TYPE <CPD>.....	249
[SOURce:]CE:TA:R <NRf+>,[NRf+],[NRf+] .....	249
[SOURce:]CE:TA:RL <NRf+>,[NRf+],[NRf+].....	249
[SOURce:]CE:TA:L <NRf+>,[NRf+],[NRf+] .....	250
[SOURce:]CE:TA:RC <NRf+>,[NRf+],[NRf+] .....	250
[SOURce:]CE:TA:C <NRf+>,[NRf+],[NRf+] .....	250
[SOURce:]CE:TA:L:AINitial <NRf+>,[NRf+],[NRf+] .....	251
[SOURce:]CE:TB:R <NRf+>,[NRf+],[NRf+] .....	251
[SOURce:]CE:TB:RS <NRf+>,[NRf+],[NRf+] .....	251
[SOURce:]CE:TB:L <NRf+>,[NRf+],[NRf+].....	252
[SOURce:]CE:TB:C <NRf+>,[NRf+],[NRf+] .....	252
[SOURce:]CE:TB:C:VINitial <NRf+>,[NRf+],[NRf+] .....	252

[SOURCE:]CE:TB:D:VOLTage <NRf+>[,NRf+][,NRf+] .....	253
[SOURCE:]PFActor[:LEVel][:IMMediate][:AMPLitude] <NRf+>[,NRf+][,NRf+] .....	253
[SOURCE:]PHASe:MODE <CPD> .....	253
[SOURCE:]VOLTage:INHibit:VON[:LEVel] <NRf+> .....	254
[SOURCE:]VOLTage:INHibit:VOFF[:LEVel] <NRf+> .....	254
[SOURCE:]VOLTage:INHibit:VON:MODE .....	254
<b>Chapter32 Input Subsystem (Load) .....</b>	<b>256</b>
INPut:COUPling <CPD> .....	256
INPut   OUTPut:PHASe:LOSS:A <STATE> .....	256
INPut   OUTPut:PHASe:LOSS:B <STATE> .....	256
INPut   OUTPut:PHASe:LOSS[:C] <STATE> .....	257
INPut:LINE:CONNEction <CPD> .....	257
INPut <state> .....	257
INPut:RECTified[:STATE] <boolean> .....	258
INPut:INTegrity <CPD> .....	258
INPut:PROTection:CLEar .....	259
INPut:PROTection:WDOG[:STATE] <state> .....	259
INPut:PROTection:WDOG:DELaY <time> .....	259
INPut:REGulation:SPeEd <CPD> .....	260
INPut:OFF:MODE <CPD> .....	260
INPut:ON:PHASe:MODE <CPD> .....	260
INPut:ON:PHASe:LEVel <NRf+> .....	261
INPut:OFF:PHASe:MODE <CPD> .....	261
INPut:OFF:PHASe:LEVel <NRf+> .....	262
INPut:BALance[:STATE] <Boolean> .....	262
<b>Chapter33 ARB Subsystem (Load) .....</b>	<b>265</b>
LIST:STATE? .....	265
LIST:REPeat <NR1> .....	265
LIST:TERMinate <CPD> .....	265
LIST:RSTate? .....	266
LIST:RECall <string> .....	266
LIST:STEP:COUNT? .....	266
LIST:CLEar .....	267
LIST:STEP <NR1>,<string> .....	267
LIST:STEP:ITEM <NR1>,<NR1>,<NRf+> .....	269
LIST:STEP:ITEM? <NR1>,<item> .....	270
LIST:NAME? .....	270
LIST:SAVe <filename> .....	271
LIST:CONFigure .....	271
LIST:CREate .....	271
LIST:FILE:NUMBer? .....	271
LIST:FILE:NAME? <index> .....	271
LIST:FILE:DELeTe <filename> .....	272
LIST:STEP:JUMP <NR1> .....	272
LIST:FUNCTion <CPD> .....	272
LIST:DCCV:STATE <Boolean> .....	273
LIST:DCCV:VOLTage <NRf+> .....	273
<b>Chapter34 SURGesag Subsystem (Load) .....</b>	<b>274</b>
SURGesag:MODE <mode> .....	274
SURGesag:PHASe:STARt <NRf+> .....	274
SURGesag:PHASe:WIDTh <NRf+> .....	275
SURGesag:ACTion <action> .....	275
SURGesag:SYMMetry <bool> .....	276
SURGesag:REPeat:COUNT <NR1> .....	276
SURGesag:PERiod:COUNT <NR1> .....	277
SURGesag:VALue:SElect <mode> .....	277
SURGesag:VALue:PERCent <NRf+> .....	278

SURGesag:VALue:SETTing <NRf+>.....	278
SURGesag:CHAN:ENABle <A B C AB AC BC ABC>.....	279
SURGesag:SAVE <string> .....	279
SURGesag:RECall <string> .....	280
SURGesag:STATe? .....	280
<b>Chapter35      WAVEform Subsystem (Load) .....</b>	<b>281</b>
WAVEform[:IMMediate] <WAVEform>,[WAVEform],[WAVEform] .....	281
PWAVEform[:IMMediate] <phase/chan>,<WAVEform> .....	281
WAVEform:EDIT:PARAmeter <phase/chan>,<percent1> .....	282
WAVEform:EDIT:THD:CLEar .....	283
WAVEform:EDIT:THD:IMPort <filename> .....	283
WAVEform:EDIT:THD:FORMula <formula>.....	283
WAVEform:EDIT:THD:DATA <order>,<string> .....	284
WAVEform:EDIT:THD:SAVE:LOCAl <filename>.....	284
WAVEform:EDIT:THD:SAVE:UDISK <filename> .....	285
WAVEform:EDIT:USERdefine:CLEar .....	285
WAVEform:EDIT:USERdefine:IMPort <filename> .....	285
WAVEform:EDIT:USERdefine:MODE <symmetry> .....	286
WAVEform:EDIT:USERdefine:DATA <index>,<normalization> .....	286
WAVEform:EDIT:USERdefine:SAVE:LOCAl <filename> .....	287
WAVEform:EDIT:USERdefine:SAVE:UDISK <filename> .....	287
<b>Chapter36      SWEep Subsystem (Load) .....</b>	<b>288</b>
SWEep:FUNCTion <mode> .....	288
SWEep:LEVel:STARt <NRf+>[,<NRf+>,<NRf+>] .....	288
SWEep:LEVel:STOP <NRf+>[,<NRf+>,<NRf+>] .....	289
SWEep:LEVel:STEP <NRf+>[,<NRf+>,<NRf+>] .....	289
SWEep:TIME:STEP <NRf+> .....	290
SWEep:MODE <mode> .....	290
SWEep:WAVEform <name>.....	291
SWEep:WAVEform:PARAmeter <NRf+> .....	291
SWEep:PSHift <NRf+> .....	292
SWEep:TERMinate <mode> .....	292
SWEep:TRIG:SOURce <mode> .....	293
SWEep:STEP:REPeat <NR1> .....	293
<b>Chapter37      IEEE-488 Common Commands.....</b>	<b>294</b>
*CLS.....	294
*ESE.....	294
*ESE? .....	295
*ESR?.....	295
*IDN?.....	295
*OPC.....	296
*RST.....	296
*SRE <NR1>.....	296
*STB?.....	297
*PSC .....	297
*SAV .....	298
*RCL .....	298

# Chapter1 SCPI Introduction

## 1.1 Overview

SCPI is short for Standard Commands for Programmable Instruments which defines a communication method of bus controller and instrument. It is based on ASCII and supply for testing and measuring instruments. SCPI command is based on hierarchical architecture which also known as tree system. In this system, Relevant Command is returned to a common node or root, so that a subsystem is formed. A part of OUTPut subsystem is listed below:

**OUTPut:**

- **SYNC {OFF|0|ON|1}**
- **SYNC:**
  - **MODE {NORMAl|CARRier}**
  - **POLarity {NORMAl|INVerted}**

OUTPut is the root class keyword, SYNC is the second keyword, MODE and POLarity are the third keyword. Colon(:) is used for separating the command keyword and the next level keyword.

## 1.2 Command Type of SCPI

SCPI has two types of commands, common and subsystem.

- Common commands generally are not related to specific operation but to controlling overall instrument functions, such as reset, status, and synchronization. All common commands consist of a three-letter mnemonic preceded by an asterisk: **\*RST \*IDN? \*SRE 8**.
- Subsystem commands perform specific instrument functions. They are organized into an inverted tree structure with the "root" at the top. The following figure shows a portion of a subsystem command tree, from which you access the commands located along the various paths.

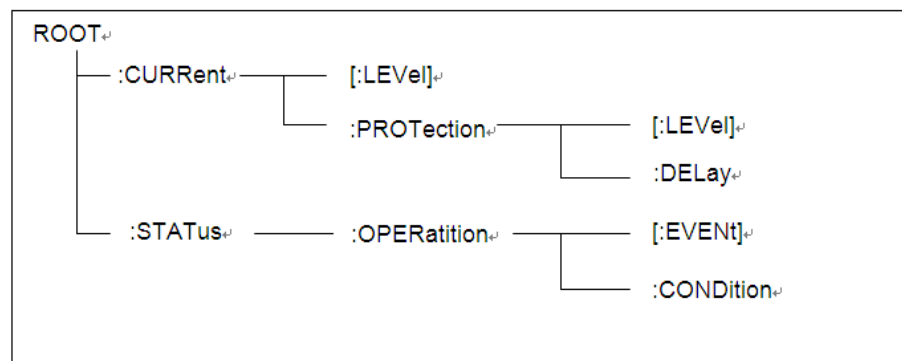

## Multiple Commands in a Message

Multiple SCPI commands can be combined and sent as a single message with one message terminator. There are two important considerations when sending several commands within a single message:

- Use a semicolon to separate commands within a message.

- Head paths influence how the instrument interprets commands.

We consider the head path as a string which will be inserted in front of every command of a message. As for the first command of a message, the head path is a null string; for each subsequent command, the head path is a string which is defined to form the current command until and including the head of the last colon separator. A message with two combined commands:

**CURR:LEV 3;PROT:STAT OFF**

The Example indicates the effect of semicolon and explains the concept of head path. Since the head path is defined to be "CURR" after "curr: lev 3", the head of the second command, "curr", is deleted and the instrument explains the second command as:

**CURR:PROT:STAT OFF**

If "curr" is explicitly included in the second command, it is semantically wrong. Since combining it with the head path will become "CURR:CURR:PROT:STAT OFF", resulting in wrong command.

## Movement in the Subsystem

In order to combine commands from different subsystems, you need to be able to reset the header path to a null string within a message. You do this by beginning the command with a colon (:), which discards any previous header path. For Example, you could clear the output protection and check the status of the Operation Condition register in one message by using a root specifier as follows:

**PROTection:CLEAr;:STATus:OPERation:CONDition?**

The following message shows how to combine commands from different subsystems as well as within the same subsystem:

**POWer:LEVeL 200;PROTection 28; :CURRent:LEVeL 3;PROTection:STATe ON**

Note the use of the optional header LEVeL to maintain the correct path within the voltage and current subsystems, and the use of the root specifier to move between subsystems.

## Including Common Commands

You can combine common commands with subsystem commands in the same message. Treat the common command as a message unit by separating it with a semicolon (the message unit separator). Common commands do not affect the header path; you may insert them anywhere in the message.

**VOLTage:TRIGgered 17.5;:INITialize;\*TRG**

**OUTPut OFF;\*RCL 2;OUTPut ON**

## Case Sensitivity

Common commands and SCPI commands are not case sensitive. You can use upper or lower, for Example:

**\*RST = \*rst**

**:DATA? = :data?**

**:SYSTem:PRESet = :system:preset**

## Long-Form and Short-Form Versions

A SCPI command word can be sent in its long-form or short-form version. However, the short-form version is indicated by upper case characters. Examples:

**:SYSTem:PRESet** long-form

**:SYST:PRES** short form

**:SYSTem:PRES** long-form and short-form combination

Note that each command word must be in long-form or short-form, and not something in between.

For Example, **:SYSTe:PRESe** is illegal and will generate an error. The command will not be executed.

## Query

Observe the following precautions with queries:

- Set up the proper number of variables for the returned data. For Example, if you are reading back a measurement array, you must dimension the array according to the number of measurements that you have placed in the measurement buffer.
- Read back all the results of a query before sending another command to the instrument. Otherwise a Query Interrupted error will occur and the unreturned data will be lost.

## 1.3 Message Type of SCPI

There are two types of SCPI messages, program and response.

- Program message: A program message consists of one or more properly formatted SCPI commands sent from the controller to the instrument. The message, which may be sent at any time, requests the instrument to perform some action.
- Response message: A response message consists of data in a specific SCPI format sent from the instrument to the controller. The instrument sends the message only when commanded by a program message called a "query."

The next figure illustrates SCPI message structure:

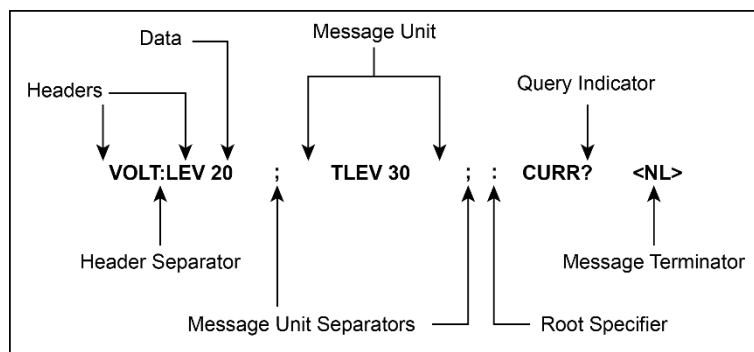

## The message unit

The simplest SCPI command is a single message unit consisting of a command header (or keyword) followed by a message terminator. The message unit may include a parameter after the header. The parameter can be numeric or a string.

**ABORt<NL>**

**VOLTage 20<NL>**

## Headers

Headers, also referred to as keywords, are instructions recognized by the instrument. Headers may be either in the long form or the short form. In the long form, the header is completely spelled out, such as **VOLTAGE**, **STATUS** and **DELAY**. In the short form, the header has only the first three or four letters, such as **VOLT**, **STAT** and **DEL**.

## Query indicator

Following a header with a question mark turns it into a query (**VOLTage?**, **VOLTage:PROtection?**). If a query contains a parameter, place the query indicator at the end of the last header (**VOLTage:PROtection?MAX**).

## Message unit separator

When two or more message units are combined into a compound message, separate the units with a semicolon (**STATus:OPERation?;QUESTionable?**).

## Root specifier

When it precedes the first header of a message unit, the colon becomes the root specifier. It tells the command parser that this is the root or the top node of the command tree.

## Message terminator

A terminator informs SCPI that it has reached the end of a message. Three permitted message terminators are:

- newline (<NL>), decimal 10 or hexadecimal 0X0A in ASCII.
- end or identify (<END>)
- both of the above (<NL><END>).

In the Examples of this guide, there is an assumed message terminator at the end of each message.

## Command execution rules

- Commands execute in the order that they are presented in the program message.
- An invalid command generates an error and, of course, is not executed.
- Valid commands that precede an invalid command in a multiple command program message are executed.
- Valid commands that follow an invalid command in a multiple command program message are ignored.

## 1.4 Response Data Type

Character strings returned by query statements may take either of the following

forms, depending on the length of the returned string:

- **<CRD>**: character response data. Permits the return of character strings.
- **<AARD>**: arbitrary ASCII response data. Permits the return of un delimited 7-bit ASCII. This data type has an implied message terminator.
- **<SRD>**: string response data. Returns string parameters enclosed in double quotes.
- **<Block>**: arbitrary block data.

## Response messages

A response message is the message sent by the instrument to the computer in response to a query command.

## Sending a response message

After sending a query command, the response message is placed in the Output Queue. When the instrument is then addressed to talk, the response message is sent from the Output Queue to the computer

## Multiple response messages

If you send more than one query command in the same program message, the multiple response messages for all the queries is sent to the computer when the instrument is addressed to talk. The responses are sent in the order that the query commands were sent and are separated by semicolons (;). Items within the same query are separated by commas (,). The following Example shows the response message for a program message that contains four single item query commands:

```
0; 1; 1; 0
```

## Response message terminator (RMT)

Each response is terminated with an LF (line feed) and EOI (end or identify). The following Example shows how a multiple response message is terminated:

```
0; 1; 1; 0; <RMT>
```

## Message exchange protocol

Two rules summarize the message exchange protocol:

- **Rule 1:** You must always tell the instrument what to send to the computer. The following two steps must always be performed to send information from the instrument other computer:
  1. Send the appropriate query command(s) in a program message.
  2. Address the instrument to talk.
- **Rule 2:** The complete response message must be received by the computer before another program message can be sent to the instrument.

## 1.5 Command Format

Formats for command display are as follows:

```
[SOURce[1|2]:]VOLTage:UNIT {VPP|VRMS|DBM}
```

```
[SOURce[1|2]:]FREQuency:CENTer  
{<frequency>|MINimum|MAXimum|DEFault}
```

Based on the command syntax, most commands (and certain Parameter) are

expressed in both upper and lower cases. Upper case refers to abbreviation of commands. Shorter program line may send commands in abbreviated format. Long-format commands may be sent to ensure better program readability.

For Example, both formats of VOLT and VOLTAGE are acceptable in the above syntax statements. Upper or lower case may be used. Therefore, formats of VOLTAGE, volt and Volt are all acceptable. Other formats (such as VOL and VOLTAG) are invalid and will cause errors.

- Parameter options with given command strings are included in the brace ( { } ). The brace is not sent along with command strings.
- Vertical stripes ( | ) separate several parameter options with given command strings. For Example, {VPP|VRMS|DBM} indicates that you may assign "APP", "VRMS" or "DBM" in the above commands. Vertical stripes are not sent along with command strings.
- Angle brackets ( < > ) in the second Example indicates that a value must be assigned to the parameter in the brace. For Example, the parameter in the angle bracket is <frequency> in the above syntax statements. Angle brackets are not sent along with command strings. You must assign a value (such as "FREQ:CENT 1000") to the parameter, unless you select other options displayed in the syntax (such as "FREQ:CENT MIN").
- Some syntax elements (such as nodes and Parameter) are included in square brackets ( [ ] ). It indicates that these elements can be selected and omitted. Angle brackets are not sent along with command strings. If no value is assigned to the optional Parameter, the instrument will select a default value. In the above Examples, "SOURce[1|2]" indicates that you may refer to source channel 1 by "SOURce" or "SOURce1" or "SOUR1" or "SOUR". In addition, since the whole SOURce node is optional (in the square bracket), you can refer to the channel 1 by omitting the whole SOURce node. It is because the channel 1 is the default channel for SOURce language node. On the other hand, if you want to refer to channel 2, "SOURce2" or "SOUR2" must be used in the program line.

### Colon (:)

It is used to separate key words of a command with the key words in next level. As shown below:

**APPL:SIN 455E3,1.15,0.0**

In this Example, APPLy command assigns a sine wave with frequency of 455 KHz, amplitude of 1.15 V and DC offset of 0.0 V.

### Semicolon (;)

It is used to separate several commands in the same subsystem and can also minimize typing. For Example, to send the following command string:

**TRIG:SOUR EXT; COUNT 10**

has the same effect as sending the following two commands:

**TRIG:SOUR EXT  
TRIG:COUNT 10**

### Question mark (?)

You can insert question marks into a command to query current values of most Parameter. For Example, the following commands will trigger to set the count as 10:

### TRIG:COUN 10

Then, you may query count value by sending the following command:

### TRIG:COUN?

You may also query the allowable minimum or maximum count as follows:

### TRIG:COUN?MIN

### TRIG:COUN?MAX

## Comma (,)

If a command requires several Parameter, then a comma must be used to separate adjacent Parameter.

## Space

You must use blank characters, [TAB] or [Space] to separate Parameter with key words of commands.

## Common commands (\*)

The IEEE-488.2 standard defines a set of common commands that perform functions such as reset, self-test, and status operations. Common commands always start with an asterisk (\*) and occupy 3 character sizes, including one or more Parameter. Key words of a command and the first parameter are separated by a space. Semicolon (;) can separate several commands as follows:

**\*RST; \*CLS; \*ESE 32; \*OPC?**

## Command terminator

Command strings sent to the instrument must end with a <Newline> (<NL>) character. IEEE-488 EOI (End or Identify) information can be used as <NL> character to replace termination command string of <NL> character. It is acceptable to place one <NL> after a <Enter>. Termination of command string always resets current SCPI command path to root level.



### NOTE

As for every SCPI message with one query sent to the instrument, the instrument will use a <NL> or newline sign (EOI) to terminate response of return. For Example, if "DISP:TEXT?" is sent, <NL> will be placed after the returned data string to terminate response. If an SCPI message includes several queries separated by semicolon (such as "DISP?;DISP:TEXT?"), <NL> will terminate response returned after response to the last query. In all cases, the program must read <NL> in response before another command is sent to the instrument, otherwise errors will be caused.

## 1.6 Data Type

SCPI language defines several data types used for program message and response messages.

- Numerical parameter

Commands requiring numerical parameter support the notations of all common decimal notations, including optional signs, decimal points, scientific notation, etc. Special values of numerical parameter are also acceptable, such as MIN, MAX and DEF. In addition, suffixes for engineering units can also be sent together with numerical parameter (including M, k, m or u). If the command accepts only some specific values, the instrument will

automatically round the input parameter to acceptable values. The following commands require numerical parameter of frequency value:

**[SOURce[1|2]:]FREQUency:CENTer {<Frequency>|MINimum|MAXimum}**

- <NR1>: represents an integer value, such as 273;
- <NR2>: represents a real number in floating-point format, such as .273;
- <NR3>: represents a real number in scientific notation, such as 2.73E+2;
- <Nrf>: The extensible form includes <NR1>, <NR2> and <NR3>;
- <Nrf+>: The extensible decimal form includes <Nrf>, MIN, MAX and DEF. MIN and MAX are the minimum and maximum finite number. Within the range of the parameter definition, DEF is the default of the parameter.

- Discrete parameter

Discrete parameter are used for settings with limited number of programming values (such as IMMEDIATE, EXTERNAL or BUS). They can use short and long format like key words of commands. They may be expressed in both upper and lower case. The query response always returns uppercase Parameter in short format. The following commands require discrete parameter in voltage unit:

**[SOURce[1|2]:]VOLTage:UNIT {VPP|VRMS|DBM}**

- Boolean parameter

Boolean parameter refer to true or false binary conditions. In case of false conditions, the instrument will accept "OFF" or "0". In case of true conditions, the instrument will accept "ON" or "1". In query of Boolean settings, the instrument will always return "0" or "1". Boolean parameter are required by the following commands:

**DISPlay {OFF|0|ON|1}**

- ASCII string parameter

String parameter may actually include all ASCII character sets. Character strings must start and end with paired quotation marks; and single quotation marks or double quotation marks are both allowed. Quotation mark separators may also act as one part of a string, they can be typed twice without any character added between them. String parameter is used in the following command:

**DISPlay:TEXT <quoted string>**

For Example, the following commands display message of "WAITING..." (without quotation marks) on the front panel of the instrument.

**DISP:TEXT "WAITING..."**

Single quotation marks may also be used to display the same message.

**DISP:TEXT 'WAITING...'**

– <SPD>: string program data. String parameters enclosed in single or double quotes.

– <CPD>: character program data.

## 1.7 Remote Interface Connection

IT8200 series electronic load are equipped with three communication interfaces as standard: USB, LAN and CAN, and two optional interfaces: RS232 and GPIB. Users can choose any one to realize communication with the computer. For detailed introduction of remote interface connection, please refer to the content in the user manual.

## Chapter2 Example of Common Commands

This chapter displays the programming examples to remotely control IT7800 power supply using SCPI commands.

If the user want to change the settings of the instrument, for instance, the output setting value, the command SYST:REM must be sent to the instrument after finishing the connection between the instrument and PC.

### Example 1: Identify the power supply

You can verify that you are communicating with the correct IT7600 power supply.

To query the identification of the power supply, enter the following command:

```
-> *IDN?
```

To check the error queue of the power supply, enter the following command:

```
-> SYST:ERR?
```

### Example 2: Common output commands

The following common commands to help you quickly implement common operations. For more command information, refer to the corresponding section. You can omit the small write parts in the following commands.

```

SYSTem:REMOte           // Set the power supply to remote operation mode.
*IDN?                   //Query the identification of the power supply
SYSTem:FUNCTion ONE     //Set the power supply mode to 1-phase
SYSTem:FUNCTion THRee   //Set the power supply mode to 3-phase
FUNCTion AC             //Set the output mode to AC mode
FUNCTion DC,CH1        //Set the output mode of CH1 to DC mode
VOLTage 220             //Set the voltage RMS to 220V
FREQuency 60.0         //Set the frequency to 60Hz
CURRent:PROTection:RMS 90 //Set the current RMS protection value to 90A
CURRent:PROTection:PEAK 270 //Set the current Peak protection value to 270A
CURR 30                //Set the current RMS limit of single phase
CURRent:DC 30          //Set the current limit of DC output
VOLTage 20             //Set the voltage RMS
VOLTage:DC 300,220,110 //Set the Vdc of three channels to 300/220/110V
OUTPut ON              //Turn on the output
MEASure:VOLTage?       //Read back the Vac RMS measurement
MEASure:CURRent?       //Read back the Iac RMS measurement
MEASure:POWer?         //Read back the power measurement
MEASure:FREQuency?    //Read back the frequency measurement
SYSTem:ERRor?         //Query the error information
SYSTem:CLEar           //Clear the error information
    
```

```
OUTPut:PROTEction:CLEar           //Clear the protection status
```

### Example 3: List function commands

The following is a detailed for editing a List of waveforms. The parameters of the waveforms can be modified according to actual needs.

```

SYST:REM           // Set the power supply to remote operation mode.
SYST:FUNC ONE     //Set the power supply mode to single mode
FUNC AC           //Set the output mode to AC mode
LIST:CREate       //Create a new list file
LIST:REP 5        //List file cycles 5 times
LIST:STEP -1, "10, 1000,0.0,1000,PHASe,90,50,1000,Sine,TIME,10,0,OFF"
                                     // Add a step, notice the content in red, the
                                     amplitude of DC must be 0.0V under AC mode. ( Three phase:
                                     "10,10,10,1000,1000,1000,0.0,0.0,0.0,1000,1000,1000,PHASe,356.9,120,1000,2
                                     40,1000,50,1000,Sine,Sine,Sine,TIME,10,0,OFF" )
LIST:STEP? 1      //Query the parameter of step1
LIST:STEP? 2      //Query the parameter of step2
LIST:SAVE "one-ac.csv" //Save the list file as one-ac.csv
SYST:ERR?        //Query the error information
    
```

### Example 4: THD Wave commands

```

SYST:REM           // Set the power supply to remote operation mode.
SYST:FUNC ONE     //Set the power supply mode to single mode
FUNC AC           //Set the output mode to AC mode
WAV:EDIT:THD:CLE // Clear memory, otherwise incorrect data
may be saved
WAV:EDIT:THD:DATA 2, "8.8,0.0" // Edit 2 THD waveform values and phase
angles
WAV:EDIT:THD:DATA 3, "8.8,0.0" // Edit 3 THD waveform values and phase
angles
WAV:EDIT:THD:DATA 4, "8.8,0.0" // Edit 4 THD waveform values and phase
angles
WAV:EDIT:THD:DATA 5, "8.8,0.0" // Edit 5 THD waveform values and phase
angles
WAV:EDIT:THD:SAVE:LOC "5.csv" // Save the present edit THD wave data to
the local file, and specify the file name (if the file name is the same, it is
considered to modify the present waveform, if the file name does not exist, it is
considered to create a new file)
WAVE "5.csv"      //Select THD wave 5.csv
VOLTage 220       //Set voltage 220V
OUTP 1            //Enable the output
FETC:VOLT:HARM? A,4 // Measurement of the voltage harmonic
    
```

amplitude of phase A, 4th harmonic

FETC:VOLT:HARM:DIS? A,4 // Measurement of phase A, voltage harmonic component of the 4th harmonic

FETC:VOLT:HARM:THD? A // Measurement of total harmonic distortion of phase A voltage

FETC:ARR:VOLT:HARM:? A,10 //This command is used to measure the harmonic amplitude of each harmonic of the voltage. the value of NR1 ranges from 0 to 50, the 0th represents the DC component, the 1st represents the fundamental wave, and the 2nd to 50th are the harmonic components. In this command, if you assign a value of 10 to NR1, the result will list the harmonic amplitude of the voltage from 0th to 10th.

## Chapter3 SCPI status register

You can get the current status of the electronic load by reading the operation status registers. The electronic load records the different status of the instrument through the four status register group, the four status register group are: status byte register, standard event register, query status register and operation status register. Status byte register records the information of the other status register.

The following table describes the status signals.

### For Power Source

Bit name	Bit	Decimal value	Definition
<b>Questionable Status Register</b>			
OV	0	1	Output is disabled by the over-voltage protection.
OC_Rms	1	2	Output is disabled by the over-current protection.RMS
OC_Peak	2	4	Output is disabled by the over-current protection. PEAK
OP_POSITIVE	3	8	Output is disabled by the over power protection. POSITIVE
sync_unlock	4	16	External Synchronization Loss of Lock
UV	5	32	Output is disabled by the under-voltage protection.
OT	6	64	Output is disabled by the over-temperature protection.
UC	7	128	Output is disabled by the under-current protection.
Errsense	8	256	Sense error
Share	9	512	Current sharing failure
Rvs	10	1024	Output terminals reversed
INH	11	2048	External output inhibited
PS	12	4096	Error protection bit (protect shutdown)
OSC	13	8192	Loop oscillation failure
UNR	14	16384	Unknown internal fault of the instrument
OC_Dc	15	32768	Capacitor overcurrent
WTG	16	32768	Command Communication Watchdog Protection
UT	17	65536	under-temperature protection
<b>Operation Status Register</b>			
OPT-WTG	1	2	1 is Waiting for trigger
OPT_ACTIVE	2	4	1 is excuting this function
NU_BIT4	4	16	Reserved, not used
NU_BIT5	5	32	Reserved, not used
OFF	6	64	The status of the instrument is off.

CC	7		Output is in constant current.
CV	8		Output is in constant voltage.
CW	9		Output is in constant current.
CR	10		Output is in constant resistance.
NU_BIT8	11		Reserved, not used
CAL	12		Calibration is in progress
DEV_Type0	13		Device type 0,Used in conjunction with device type 1
DEV_Type1	14		Device type 1
WORK_Mode0	15		Work mode 0
WORK_Mode1	16		Work mode 1
WORK_FUNC	17-21		0=normal,1=list,2=sweep,3=ext analog,4=law,5=island,6=signal simulator,7=signal sample,8=aircraft test,9=interharmonic func
SURGE_Sag	22		Surge/Trap mode
DIMMING	23		Dimming mode
sync_mode	24-25		External synchronization mode
REMOTE_LOCK	26		Remote control lock
LOCAL_LOCK	27		Local control lock
sense	28		Sense enable
Rmt	29		Remote control mode
<b>Standard Event Register</b>			
OPC	0	1	All commands before and including *OPC have been executed.
QYE	2	4	The instrument tried to read the output buffer but it was empty, a new command line was received before a previous query has been read, or both the input and output buffers are full.
DDE	3	8	A device-specific error, including a self-test error, calibration error or other device-specific error occurred.
EXE	4	16	An execution error occurred.
CME	5	32	A command syntax error occurred.
PON	7	128	Power has been cycled since the last time the event register was read or cleared.
<b>Status Byte Register</b>			
EAV	2	4	
QUES	3	8	This bit is set to 1 when any one status of enabled query status register changes.
MAV	4	16	Output buffer available.
ESB	5	32	Bit ESB is set to 1 when the status of an enabled standard event status.

RQS/MSS	6	64	Register changes.
OPER	7	128	If the status of enabled operation register changes, then this bit is set to 1.

## For Load

Bit name	Bit	Decimal value	Definition
<b>Questionable Status Register</b>			
OV	0	1	Over Voltage protection
OC_Rms	1	2	RMS Over current protection
OC_Peak	2	4	PEAK over current protection
OP_POSITIVE	3	8	Over positive power protection
UV	5	32	Under voltage
OT	6	64	Over temperature protection
ERR_SENSE	8	256	Sense error
INH	11	2048	Input inhibit
PS	12	4096	protect state
OSC	13	8192	Oscillating circuit
OV_Peak	16	65536	Over peak voltage protection
FE	17	131072	Frequency error
WDOG	18	262144	Watch dog protection
OP_NEG	19	524288	Negative power protection
UT	20	1048576	under-temperature protection
VE	21	2097152	Input Voltage Abnormal Protection
<b>Operation Status Register</b>			
LIST_WTG	0	1	LIST waiting for trigger signal
LIST_ACTIVE	1	2	LIST is running
OFF	2	4	Input is off
CC	3	8	Constant current
CV	4	16	Constant voltage
CW	5	32	Constant power
CR	6	64	Constant resistance
CS	7	128	Constant apparent power
REMOTE_LOCK	8	256	Remote lock
LOCAL_LOCK	9	512	Local lock
RMT	10	1024	Remote mode
CAL	11	2048	Calibration
DEV_TYPE	12--13		Device type(single phase/ three phase/reverse phase) (bit13:bit12->00b/01b/10b)
OPERATION_MODE	14--15		Operation mode(source/load/current source)
SENSE	16	65536	SENSE enabled

Bit name	Bit	Decimal value	Definition
<b>Questionable Status Register</b>			
WORK_FUNC	17--19		Work function (NORMAL/LIST/SWEEP)
CONST_MODE	20--23		Constant mode (BIT23:BIT20) AC:CC/CR/CP/CS/NCR->01b/11b/10b/100b/110b; DC:CV/CC/CP/CR/CC+CV/CR+CV/CP+CV/CC+CR/CC+CV+CP+CR->00b/01b/10b/11b/100b/101b/110b/111b/1000b;
WORK_MODE	24	16777216	Work mode (AC/DC)
SURGE_SAG	25	33554432	Surge and sag
EXT_ANALOG	26	67108864	Analog
SYNC_MODE	27	134217728	External Synchronization
RECTIFIED	28	268435456	Rectified mode
UPF	29	536870912	Unit power factor
LINE_TYPE	30	1073741824	Connection type(DeLta or WYE)
PHASE_LACK	31	2147483648	Phase lost

## Chapter4 STATus Commands

### STATus:QUEStionable[:EVENT]?

This command can be used to read the value in query event register. The power supply will return a decimal number corresponding to the binary weighted sum of each unit digit of register. These digits will be latched. After executing this command, the query event register will be cleared.

#### Query syntax

STATus:QUEStionable[:EVENT]?

#### Arguments

None

#### Returns

<NR1>

#### Example

```
-> STAT:QUES?
<- 4140
```

#### Related syntax

STATus:QUEStionable:ENABLE

The definition of query event enable register is as follows

Bit	7	6	5	4	3	2	1	0
Name	OT	FAN err	OPP	OCPpeak	OCPrms	UVPrms	OVPpeak	OVPrms
Value Bit	128	64	32	16	8	4	2	1
Weight								

### STATus:QUEStionable:CONDition?

This command is used to read the value of query condition register.

This is a read-only register, which directly reflects those bits in the instrument's problem state that are set to 1 or 0, and will not be latched. After the command is executed, the value of the query condition register will not be cleared.

#### Query syntax

STATus:QUEStionable:CONDition?

#### Arguments

None

#### Returns

<NR1> This is a decimal value with a binary weighted sum.

## STATus:QUEStionable:ENABLE <NR1>

Sets the value of the enable register for the Questionable Status group. The enable register is a mask for enabling specific bits from the Operation Event register to set the QUES (questionable summary) bit of the Status Byte register. STATus:PRESet clears all bits in the enable register. \*CLS does not clear the enable register, but does clear the event register.

### Syntax

STATus:QUEStionable:ENABLE <state>

### Arguments

0-0x7ffffff

### Default value

0|OFF

### Example

STAT:QUES:ENAB 128

### Query syntax

STATus:QUEStionable:ENABLE?

### Returns

<NR1>

## STATus:QUEStionable:NTRansition <NR1>

Sets the value of the NTR (Negative-Transition) registers. These registers serve as a polarity filter between the Questionable Condition and Questionable Event registers. When a bit in the NTR register is set to 1, then a 1-to-0 transition of the corresponding bit in the Questionable Condition register causes that bit in the Questionable Event register to be set. STATus:PRESet sets all bits in the PTR registers and clears all bits in the NTR registers.

- If the same bits in both NTR and PTR registers are set to 1, then any transition of that bit at the Questionable Condition register sets the corresponding bit in the Questionable Event register.
- If the same bits in both NTR and PTR registers are set to 0, then no transition of that bit at the Questionable Condition register can set the corresponding bit in the Questionable Event register.
- The value returned is the binary-weighted sum of all enabled bits in the register.

### Syntax

STATus:QUEStionable:NTRansition <NR1>

## Arguments

0-0x7ffffff

## Default value

0

## Example

STAT:QUES:NTR 128

## Query syntax

STATus:QUEStionable:NTRansition?

## Returns

<NR1> This is a decimal value with a binary weighted sum.

## STATus:QUEStionable:PTRansition

Sets the value of the PTR (Positive-Transition) registers. These registers serve as a polarity filter between the Questionable Condition and Questionable Event registers. When a bit in the PTR register is set to 1, then a 0-to-1 transition of the corresponding bit in the Questionable Condition register causes that bit in the Questionable Event register to be set. STATus:PRESet sets all bits in the PTR registers and clears all bits in the NTR registers.

## Syntax

STATus:QUEStionable:PTRansition <NR1>

## Arguments

0-0x7ffffff

## Default value

0

## Example

STAT:QUES:PTR 128

## Query syntax

STATus:QUEStionable:PTRansition?

## Returns

<NR1> This is a decimal value with a binary weighted sum.

## STATus:OPERation[:EVENT]?

This command can read the parameter from operation event register. After executing this order, operation event register is reset.

### Query syntax

STATus:OPERation[:EVENT]?

### Arguments

None

### Returns

<NR1>

### Related syntax

STATus:OPERation:ENABle

Bit definition of operation event register:

Bit	7	6	5	4	3	2	1	0
Name	n.u	n.u	n.u	n.u	n.u	WTG	LIST	CAL
Value Bit Weight						4	2	1

## STATus:OPERation:CONDition?

This command can read the parameter from the operation condition register.

This is a read-only register, which directly reflects those bits in the operating state of the instrument are set to 1 or 0, and will not be latched. After the command is executed, the value of the query condition register will not be cleared.

### Query syntax

STATus:OPERation:CONDition?

### Arguments

None

### Example

STATus:OPERation:CONDition?

### Returns

<NR1> This is a decimal value with a binary weighted sum.

## STATus:OPERation:ENABle <NR1>

Sets the value of the enable register for the Operation Status group. The enable register is a mask for enabling specific bits from the Operation Event register to set the OPER (operation summary) bit of the Status Byte register. STATus:PRESet clears all bits in the enable register. \*CLS does not clear the enable register, but does clear the event register.

### Syntax

STATus:OPERation:ENABle <NR1>

## Arguments

0-0x7ffffff

## Default value

0|OFF

## Example

STATus:OPERation:ENABle 128

## Query syntax

STATus:OPERation:ENABle?

## Returns

<NR1>

# STATus:OPERation:NTRansition<NR1>

Sets the value of the NTR (Negative-Transition) registers. These registers serve as a polarity filter between the Operation Condition and Operation Event registers. When a bit in the NTR register is set to 1, then a 1-to-0 transition of the corresponding bit in the Operation Condition register causes that bit in the Operation Event register to be set. STATus:PRESet sets all bits in the PTR registers and clears all bits in the NTR registers.

- If the same bits in both NTR and PTR registers are set to 1, then any transition of that bit at the Operation Condition register sets the corresponding bit in the Operation Event register.
- If the same bits in both NTR and PTR registers are set to 0, then no transition of that bit at the Operation Condition register can set the corresponding bit in the Operation Event register.
- The value returned is the binary-weighted sum of all enabled bits in the register.

## Syntax

STATus:OPERation:NTRansition <NR1>

## Arguments

0-0x7ffffff

## Default value

0

## Example

STATus:OPERation:NTRansition 128

## Query syntax

STATus:OPERation:NTRansition?

## Returns

<NR1>

## STATus:OPERation:PTRansition

Sets the value of the PTR (Positive-Transition) registers. These registers serve as a polarity filter between the Operation Condition and Operation Event registers. When a bit in the PTR register is set to 1, then a 0-to-1 transition of the corresponding bit in the Operation Condition register causes that bit in the Operation Event register to be set. STATus:PRESet sets all bits in the PTR registers and clears all bits in the NTR registers.

## Syntax

STATus:OPERation:PTRansition <NR1>

## Arguments

0-0x7ffffff

## Default value

0

## Example

STATus:OPERation:PTRansition 128

## Query syntax

STATus:OPERation:PTRansition?

## Returns

<NR1>

## STATus:PRESet

This command is used to preset the value of the status register.

## Syntax

STATus:PRESet

## Example

STAT: PRES

## Chapter5 SYSTem Subsystem

### SYSTem:VERSion?

This command queries the SCPI version of the instrument.

#### Syntax

SYSTem:VERSion?

#### Arguments

None

#### Reset value

Not applicable

#### Example

```
- > SYST:VERS?
< - "1993.1"
```

#### Returns

SRD

### SYSTem:ERRor?

This command reads the error code and error information.

#### Syntax

SYSTem:ERRor?

#### Arguments

None

#### Example

```
- > SYST:ERR?
< - 0,"NO_ERR"
```



#### Note

- ◆ “- >” indicates the commands that you send to instrument.
- ◆ “< -” indicates the response from instrument.

### SYSTem:PRESet

This command is used to make the instrument in a state suitable for panel operation(reset).

#### Syntax

SYSTem:PRESet

## Example

SYST:PRES

## SYSTEM:POSetup <CPD>

This command is used to set and query some parameters or working status when the instrument is powered on.

- RST: The default value indicates that the factory initialization value is displayed when the instrument is powered on. The specific parameters are described in \*RST.
- LAST\_ON: Indicates when powered on, the instrument will remain the same parameter settings as last time you turned off the instrument.
- LAST\_OFF: Indicates when powered on, the instrument will remain the same settings as last time you turned off the instrument, but the output state is Off.

## Syntax

SYSTEM:POSetup <CPD>

## Arguments

RST|LAST|LAST\_OFF

## Default value

RST

## Returns

None

## Example

SYST:POS RST

## Query syntax

SYSTEM:POSetup?

## SYSTEM:CLEAr

This command is used to clear the error queue.

## Syntax

SYSTEM:CLEAr

## Example

SYST:CLE

## SYSTEM:REMote

This command takes the instrument out of front-panel control mode and switches

it to remote control mode.

#### Syntax

SYSTem:REMOte

#### Example

SYST:REM

## **SYSTem:LOCAl**

This command is used to switch the power supply into the control from the front panel.

#### Syntax

SYSTem:LOCAl

#### Example

SYST:LOC

## **SYSTem:RWLock**

This command locks the power supply in remote control mode. When this command is executed, pressing the LOCAL button does not switch the instrument to local control mode.

#### Syntax

SYSTem:RWLock

#### Arguments

None

#### Reset value

Not applicable

#### Example

SYST:RWL

## **SYSTem:BEEPer:IMMediate**

This command tests the beeper function of the power supply. If it passes the test, a beep is issued.

#### Syntax

SYSTem:BEEPer:IMMediate

#### Arguments

None

**Reset value**

Not applicable

**Example**

SYST:BEEP:IMM

**SYSTem:BEEPer[:STATe] <CPD>**

This command enables or disables the beeper function of the power supply.

**Syntax**

SYSTem:BEEPer[:STATe] &lt;CPD&gt;

**Arguments**

OFF|ON

**Default value**

ON

**Returns**

OFF/ON

**Example**

SYST:BEEP OFF

**Related syntax**

SYSTem:BEEPer[:STATe]?

**SYSTem:BRIGhtness:LEVel <NR1>**

This command is used to set and query the screen brightness of the present power supply, the setting range is 1-10.

**Syntax**

SYSTem:BRIGhtness:LEVel &lt;NR1&gt;

**Arguments**

1-10

**Returns**

&lt;NR1&gt;

**Default value**

8

**Example**

SYST:BRIG:LEVel 10

### Query syntax

SYSTem:BRIGhtness:LEVel?

## **SYSTem:TOUCh[:STATe] <CPD>**

This command is used to set and query the touch screen status of the screen, 0|OFF means the touch screen is turned off, 1|ON means the touch screen is turned on.

### Syntax

SYSTem:TOUCh[:STATe] <CPD>

### Arguments

<CPD>

0|OFF|1|ON

### Returns

0|1

### Example

SYST:TOUC 0

### Query syntax

SYST:TOUC?

## **SYSTem:LANGUage <CPD>**

This command is used to set and query the language display of the power supply, Chinese or English can be selected.

### Syntax

SYSTem:LANGUage <CPD>

### Arguments

ENGLish|CHINese

### Example

SYST:LANG CHIN

### Query syntax

SYSTem:LANGUage?

## **SYSTem:SOFT:KEYBoard[:STATe] <CPD>**

This command is used to set and query the UI soft keyboard switch of the present power supply.

### Syntax

SYSTem:SOFT:KEYBoard[:STATe] <CPD>

## Arguments

0|OFF|1|ON

## Example

SYST:SOFT:KEYB 1

## Query syntax

SYSTem:SOFT:KEYBoard[:STATe]?

## **SYSTem:KNOB:IMMEDIATE:EFFective <CPD>**

This command is used to set and query whether the parameters adjusted by the knob take effect immediately.

## Syntax

SYSTem:KNOB:IMMEDIATE:EFFective <CPD>

## Arguments

0|OFF|1|ON

## Default value

0

## Returns

0|1|

## Example

SYST:KNOB:IMM:EFF 1

## Query syntax

SYSTem:KNOB:IMMEDIATE:EFFective?

## **SYSTem:COMMunicate:USB:TYPE <CPD>**

This command is used to set and query the USB interface type. IT7900 series power supply USB can be set as the host or device type, used to set the USB interface for communication or as a storage disk. When set as host type, it is used as a storage disk, and when set as device type, it is used as a communication interface.

## Syntax

SYSTem:COMMunicate:USB:TYPE <CPD>

## Arguments

DEVice|HOST

## Defaults

HOST

## Returns

DEVice|HOST

## Example

SYST:COMM:USB:TYPE HOST

## Query syntax

SYSTem:COMMunicate:USB:TYPE?

## **SYSTem:COMMunicate:SElect <CPD>**

This command is used to set and query the communication method. This series instrument comes standard with four communication interfaces: USB, LAN, VCP and CAN, and supports two optional communication interfaces: GPIB, RS-232. And the RS232 and GPIB options can be selected only after the communication board corresponding to RS232 and GPIB is successfully inserted into the corresponding position on the rear panel of the instrument.

## Syntax

SYSTem:COMMunicate:SElect <CPD>

## Arguments

TMC|VCP

## Defaults

VCP

## Returns

TMC|VCP

## Example

SYST:COMM:SEL VCP //Set the USB communication interface to VCP

## Query syntax

SYSTem:COMMunicate:SElect?

## **SYSTem:COMMunicate:GPIB:ADDRess <NR1>**

This command sets and queries the GPIB address of the power supply.

## Syntax

SYSTem:COMMunicate:GPIB:ADDRess <NR1>

## Arguments

<NR1>

Settable range :1~30

## Default value

1

## Returns

&lt;NR1&gt;

## Example

SYST:COMM:GPIB:ADDR 2

## Query syntax

SYSTem:COMMunicate:GPIB:ADDRess?

**SYSTem:COMMunicate:SERial:BAUDrate <CPD>**

This command sets and queries the baud rate of the serial port.

## Syntax

SYSTem:COMMunicate:SERial:BAUDrate &lt;CPD&gt;

## Arguments

&lt;CPD&gt;

115200|57600|38400|19200|9600|4800

## Default value

9600

## Returns

&lt;CPD&gt;

## Example

SYST:COMM:SER:BAUD 4800

## Query syntax

SYSTem:COMMunicate:SERial:BAUDrate?

**SYSTem:COMMunicate:LAN:IP[:CONFIguration] <ip>**

This command is used to set and query the IP address of the instrument.

## Syntax

SYSTem:COMMunicate:LAN:IP[:CONFIguration] &lt;SPD&gt;

## Arguments

&lt;SPD&gt;

## Defaults

"192.168.0.11"

## Returns

<SPD>

## Example

```
SYST:COMM:LAN:IP "192.168.0.11"
```

## Query syntax

```
SYSTem:COMMunicate:LAN:IP[:CONFiguration]?
```

# **SYSTem:COMMunicate:LAN:IP[:CONFiguration]:MODE <CPD>**

This command is used to set and query the IP mode of the LAN port.

- MANual: the user manually sets the IP-related parameters.
- AUTO: the system automatically configures IP related parameters.

## Syntax

```
SYSTem:COMMunicate:LAN:IP[:CONFiguration]:MODE <CPD>
```

## Arguments

<CPD>

AUTO|MANual

## Default value

MANual

## Returns

AUTO|MANual

## Example

```
SYST:COMM:LAN:IP:MODE AUTO //Set the IP mode of the LAN interface to  
automatic configuration mode.
```

## Query syntax

```
SYSTem:COMMunicate:LAN:IP[:CONFiguration]:MODE?
```

# **SYSTem:COMMunicate:LAN:SMASK <SPD>**

This command is used to set and query the subnet mask of the LAN.

## Syntax

```
SYSTem:COMMunicate:LAN:SMASK <SPD>
```

## Arguments

<SPD>

**Default value**

"255.255.255.0"

**Returns**

<SPD>

**Example**

SYST:COMM:LAN:SMAS "255.255.255.1" //This command is used to set the subnet mask of the LAN.

**Query syntax**

SYSTem:COMMunicate:LAN:SMASk?

**SYSTem:COMMunicate:LAN:DGATeway <SPD>**

This command is used to set and query the gateway address of the LAN communication.

**Syntax**

SYSTem:COMMunicate:LAN:DGATeway <SPD>

**Arguments**

<SPD>

**Default value**

"192.168.0.1"

**Example**

SYST:COMM:LAN:DGAT "192.168.0.1"

**Query syntax**

SYST:COMM:LAN:DGAT?

**SYSTem:COMMunicate:LAN:RAWSocketport <port>**

This command is used to set and query the socket port of the LAN communication.

**Syntax**

SYSTem:COMMunicate:LAN:RAWSocketport <port>

**Arguments**

<SPD>

**Default value**

"30000"

### Example

```
SYSTem:COMMunicate:LAN:RAWSocketport 30001 //Set the socket port to  
30001
```

### Query syntax

```
SYSTem:COMMunicate:LAN:RAWSocketport? //Query the socket port of  
LAN interface.
```

## **SYSTem:OPERation:CATalog?**

Queries the operating modes supported by the device.

### Syntax

```
SYSTem:OPERation:CATalog?
```

### Arguments

Null

### Returns

```
VOLTage|LOAD|CURRent
```

## **SYSTem:OPERation:MODE <CPD>**

Sets the operation mode of the machine.

### Syntax

```
SYSTem:OPERation:MODE <CPD>
```

### Arguments

```
VOLTage|LOAD|CURRent
```

### Example

```
SYSTem:OPERation:MODE VOLT
```

### Query syntax

```
SYSTem:OPERation:MODE?
```

### Returns

```
VOLTage
```

## **SYSTem:FUNCTion <CPD>**

This command is used to set the mode of the current power supply, including single-phase/three-phase/reverse/multi-channel. Multi-channel mode is not supported in load mode.

### Syntax

```
SYSTem:FUNCTion <device>
```

**Arguments**

ONE|THRee|DIFFeRence|MULTiChannel

**Default value**

ONE

**Returns**

ONE|THRee|DIFFeRence|MULTiChannel

**Example**

SYST:FUNC ONE

**Query syntax**

SYSTem:FUNCTion?

**SYSTem:FIBer:STATe?**

This command is used to detect the fiber status.

**Syntax**

SYSTem:FIBer:STATe?

**Example**

SYST:FIB:STAT?

---

## Chapter6 ABORt Subsystem

---

### **ABORt:ACQuire**

This command is used to stop the sweep function.

#### Syntax

ABORt:ACQuire

#### Example

ABOR:ACQ

### **ABORt:LIST**

This command is used to discard the present measurement.

#### Syntax

ABORt:LIST

#### Example

ABOR:LIST

### **ABORt:SWEep**

This command is used to stop the sweep function.

#### Syntax

ABORt:SWEep

#### Example

ABOR:SWE

### **ABORt:SURGesag**

This command is used to stop the surge/trap wave function.

#### Syntax

ABORt:SURGesag

#### Example

ABORt:SURGesag

---

## Chapter7 INITiate Subsystem

---

### **INITiate[:IMMediate]:ACQuire**

This command is used to Initiates the measurement trigger system.

#### Syntax

INITiate[:IMMediate]:ACQuire

#### Example

INIT:ACQ

### **INITiate[:IMMediate]:LIST**

This command is used to start up the LIST function.

#### Syntax

INITiate[:IMMediate]:LIST

#### Example

INIT:LIST

### **INITiate[:IMMediate]:SWEep**

This command is used to initialize the sweep function.

#### Syntax

INITiate[:IMMediate]:SWEep

#### Example

INIT:SWE

### **INITiate[:IMMediate]:SURGesag**

This command is used to initialize the surge/trap wave function.

#### Syntax

INITiate[:IMMediate]:SURGesag

#### Example

INIT:SURG

---

## Chapter8 CONFigure IO Subsystem

---

### **[CONFigureable:]IO:SElect <NR1>**

This command is used to select and query IO.

#### Syntax

```
[CONFigureable:]IO:SElect <NR1>
```

#### Argument

<NR1>

[1,7]

#### Query syntax

```
[CONFigureable:]IO:SElect?
```

#### Returns

<NR1>

#### Example

```
IO:SEL 7
```

### **[CONFigureable:]IO:REVerse <NR1>,<CPD>**

This command is used to set and query whether the IO port signal is reversed. The first parameter is the IO number, and the second parameter is the reverse state.

#### Syntax

```
[CONFigureable:]IO:REVerse <NR1>,<CPD>
```

#### Argument

<NR1>,<CPD>

[1,7],0|OFF|1|ON

#### Query syntax

```
[CONFigureable:]IO:REVerse? <NR1>
```

#### Returns

CPD

#### Example

```
IO:REV 7,0
```

### **[CONFigureable:]IO:TYPE <NR1>,<CPD>**

This command is used to set and query the IO type.

Note:

1: LIVing|LATCh

2: PSClear

3: PSState

4: SYIN|SYOut

5: OFFState

6: TIN1|TOUT1

7: TIN2|TOUT2

Only specific IO can be configured for the above special functions. IORD|IOWR all IO can be configured.

## Syntax

[CONFigureable:]IO:TYPE <NR1>,<CPD>

## Argument

NR1: [1,7]

CPD:

LIVing|LATCh|PSClear|PSState|SYIN|SYOut|OFFState|TIN1|TIN2|TOUT1|TOUT2|IORD|IOWR

## Query syntax

[CONFigureable:]IO:TYPE? <NR1>

## Returns

CPD

## Example

IO:TYPE 1,LIV

## [CONFigureable:]IO:TOUT:SOURce <CPD1>,<CPD2>

This command is used to set and query the trig source of IO-6 and IO-7 and whether the function is on or off.

Note: this command should be used in conjunction with IO:SElect, that is, select IO-6 or IO-7, and then set the trigger source.

## Syntax

IO:TOUT:SOURce <CPD1>,<CPD2>

## Argument

CPD1:AC|DC|FREQuency|LIST (For source mode)

CPD1:AC|DC|LIST (For load mode)

CPD2:0|OFF|1|ON

### Query syntax

IO:TOUT:SOURce? <CPD>

### Returns

<CPD>

### Example

IO:TOUT:SOURce ON

## **[CONFigureable:]IO:STATE <NR1>,<CPD>**

When IO is set to output mode, it can output high level (False) or low level (True). This command is used to set and query the output level status, 0 means FALSE, 1 means True.

### Syntax

[CONFigureable:]IO:STATE <NR1>,<CPD>

### Argument

NR1:[1,7]

CPD:0|OFF|1|ON

### Query syntax

[CONFigureable:]IO:STATE?

### Example

IO:STATE 1,ON

## Chapter9 TRIGger Subsystem

### TRIGger:LIST:SOURce <source>

This command is used to set and query the trigger source of the LIST function.

#### Syntax

TRIGger:LIST:SOURce <source>

#### Argument

<CPD>  
 IMMEDIATE|MANual|BUS|TRIG1|TRIG2

#### Query syntax

TRIGger:LIST:SOURce?

#### Returns

IMMEDIATE|MANual|BUS|TRIG1|TRIG2

#### Example

TRIG:LIST:SOUR MAN //The trigger source of LIST function is selected as manual panel trigger.

### TRIGger:SWEEP:SOURce <CPD>

This command is used to set and query the trigger source of SWEEP function.

#### Syntax

TRIGger:SWEEP:SOURce <CPD>

#### Argument

<CPD>  
 IMMEDIATE|MANual|BUS|TRIG1|TRIG2

#### Query syntax

TRIGger:SWEEP:SOURce?

#### Returns

IMMEDIATE|MANual|BUS|TRIG1|TRIG2

#### Example

TRIG:SWE:SOUR MAN

## TRIGger:SURGesag:SOURce <CPD>

This command is used to set and query the trigger source of the surge/trap wave function.

### Syntax

TRIGger:SURGesag:SOURce <CPD>

### Argument

<CPD>  
IMMediate|MANual|BUS|TRIG1|TRIG2

### Query syntax

TRIGger:SURGesag:SOURce?

### Returns

IMMediate|MANual|BUS|TRIG1|TRIG2

### Example

TRIG:SURG:SOUR MAN

## TRIGger:SCOPE:SOURce <CPD>

This command is used to set and query the trigger source of the oscilloscope function.

### Syntax

TRIGger:SCOPE:SOURce <CPD>

### Argument

<CPD>  
<1-6>|TRIG1|TRIG2

### Query syntax

TRIGger:SCOPE:SOURce?

### Example

TRIG:SCOP:SOUR TRIG1

## TRIGger:SCOPE:MODE <CPD>

This command is used to set and query the mode of the oscilloscope function.

### Syntax

TRIGger:SCOPE:MODE <CPD>

### Argument

<CPD>

AUTO|NORMal

#### Query syntax

TRIGger:SCOPE:MODE?

#### Returns

AUTO|NORMal

#### Example

TRIG:SCOP:MODE AUTO

## TRIGger:SCOPE:SLOPe <CPD1>

This command is used to set and query the slope of the oscilloscope function.

#### Syntax

TRIGger:SCOPE:SLOPe <CPD1>

#### Argument:

<CPD>

RISE|FALL|BOTH

#### Query syntax

TRIGger:SCOPE:SLOPe?

#### Returns

RISE|FALL|BOTH

#### Example

TRIG:SCOP:SLOP BOTH

## TRIGger:FORCe

This command is used to trigger.

#### Syntax

TRIGger:FORCe

#### Example

TRIGger:FORCe

---

## Chapter10 PARAllel Subsystem

---

### PARAllel:ROLE <role>

This command sets and queries the power supply to single, slave or master mode in the parallel operation.

#### Syntax

PARAllel:ROLE <role>

#### Argument

<CPD>  
SINGle|SLAVe|MASTer

#### Query syntax

PARAllel:ROLE?

#### Returns

SINGle|SLAVe|MASTer

#### \*RST

SINGle

#### Example

```
PAR:ROLE SLAV           //Set the machine to slave mode.  
PAR:ROLE?              //Query the parallel role of the present instrument.
```

### PARAllel:NUMBer <number>

This command sets and queries the total instrument number in the parallel operation, and the setting range is 2-16.

#### Syntax

PARAllel:NUMBer <number>

#### Argument

<NR1>

#### Query syntax

PARAllel:NUMBer?

#### Returns

<NR1>

#### Example

```
PAR:NUMB 3             //Set the total number of parallel machines to 3.
```

PAR:NUMB? //Query the total number of parallel machines.

## **PARallel:NODE:NUMBER?**

This command is used to obtain the total number of nodes after the optical fiber is paralleled.

### Syntax

PARallel:NODE:NUMBER?

### Argument

<NR1>

1~64

### Example

PAR:NODE:NUMB?

---

## Chapter11 SCOPE Subsystem

---

### **SCOPE:AUTO**

This is an automatic setting command of the oscilloscope.

#### Syntax

SCOPE:AUTO

#### Example

SCOPE:AUTO

### **SCOPE:RUN**

This is an operation command of the oscilloscope.

#### Syntax

SCOPE:RUN

#### Example

SCOPE:RUN

### **SCOPE:SINGLE**

This command is used to capture single-shot oscilloscope data.

#### Syntax

SCOPE:SINGLE

#### Example

SCOPE:SINGLE

### **SCOPE:STOP**

This is a stop command of the oscilloscope.

#### Syntax

SCOPE:STOP

#### Example

SCOPE:STOP

### **SCOPE:TIMEbase:SCALE <NRf>**

This command is used to set and query the time scale of the oscilloscope, unit: s.  
<0.001-1.0>

### Syntax

SCOPE:TIMEbase:SCALE <NRf>

### Argument

[MINimum|MAXimum]

### Query syntax

SCOPE:TIMEbase:SCALE?

### Returns

<NRf>

### Example

SCOPE:TIMEbase:SCALE 0.5

## SCOPE:VOLTage:SCALE <NRf>

This command is used to set and query the voltage scale of the oscilloscope, unit: V.

### Syntax

SCOPE:VOLTage:SCALE <NRf>

### Argument

[MINimum|MAXimum]

### Query syntax

SCOPE:VOLTage:SCALE?

### Returns

<NRf>

### Example

SCOPE:VOLTage:SCALE 10

## SCOPE:CURREnt:SCALE <NRf>

This command is used to set and query the current scale of the oscilloscope, unit: A.

### Syntax

SCOPE:CURREnt:SCALE <NRf>

### Argument

[MINimum|MAXimum]

### Query syntax

SCOPE:CURREnt:SCALE?

## Returns

<NRf>

## Example

SCOPE:CURRent:SCALE 30

## SCOPE:TIMEbase:DELay <NRf>

This command is used to set and query the trigger delay of the oscilloscope, unit: s.

## Syntax

SCOPE:TIMEbase:DELay <NRf>

## Argument

[MINimum|MAXimum]

## Query syntax

SCOPE:TIMEbase:DELay?

## Returns

<NRf>

## Example

SCOPE:TIMEbase:DELay 3

## SCOPE:TRIGger:SOURce

This command is used to set the trigger source of surge/sag function.

## Syntax

SCOPE:TRIGger:SOURce

## Argument

MANual|BUS|TRIG1|TRIG2

## Query syntax

SCOPE:TRIGger:SOURce?

## Returns

MANual|BUS|TRIG1|TRIG2

## Example

SCOPE:TRIGger:SOURce TRIG1

## SCOPE:TRIGger:LEVel <NRf>

This command is used to set and query the trigger level of the oscilloscope.

### Syntax

SCOPE:TRIGger:LEVel <NRf>

### Argument

[MINimum|MAXimum]

### Query syntax

SCOPE:TRIGger:LEVel?

### Returns

<NRf>

### Example

SCOPE:TRIGger:LEVel MIN

## **SCOPE:TRIGger:SLOPe <CPD>**

This command is used to set and query the trigger edge of the oscilloscope.

### Syntax

SCOPE:TRIGger:SLOPe <CPD>

### Argument

<RiSE|FALL|BOTH>

### Query syntax

SCOPE:TRIGger:SLOPe?

### Returns

<RiSE|FALL|BOTH>

### Example

SCOPE:TRIGger:SLOPe BOTH

## **SCOPE:TRIGger:MODE <CPD>**

This command is used to set and query the trigger mode of the oscilloscope.

### Syntax

SCOPE:TRIGger:MODE <CPD>

### Argument

<AUTO|NORMAl>

### Query syntax

SCOPE:TRIGger:MODE?

## Returns

<AUTO|NORMAL>

## Example

SCOPE:TRIGger:MODE AUTO

## SCOPE:LINE:SELECTION

This command is used to set and query the curve displayed by the oscilloscope, up to 6 curves can be displayed.

## Syntax

SCOPE:LINE:SELECTION

## Argument

<1-6>,<Off|On|0|1>

## Query syntax

SCOPE:LINE:SELECTION?

## Example

SCOPE:LINE:SELECTION 1,ON

## SCOPE:STATUS?

Query the present status of the oscilloscope.

## Syntax

SCOPE:STATUS?

## Returns

"Stop"|"Ready"  
"Roll"|"Auto"|"Trig'd"

## Example

SCOPE:STATUS?

## SCOPE:RSTate?

Query the running status of the oscilloscope.

## Syntax

SCOPE:RSTate?

## Returns

"RUN"|"STOP"  
"SINGLE"

## Example

SCOPe:RState?

## SCOPe:WAVeform:DATA?

This command is used to get the data of the oscilloscope.

## Syntax

SCOPe:WAVeform:DATA?

## Example

SCOPe:WAVeform:DATA?

## SCOPe:RANGe:CATalog?

This command is used to get voltage and current scale range options.

## Syntax

SCOPe:RANGe:CATalog?

## Returns

2/5/10/20/50/100/200/500,0.2/0.5/1/2/5/10/20/50

## Example

SCOPe:RANGe:CATalog?

## SCOPe:RECOrd:LENGth <0.6|6|60|600>

Oscilloscope data points collected in one second, 0.6 that is 600 points, 600 that is 600000, with the time scale and sampling frequency, sampling frequency multiplied by the screen time scale to be less than or equal to the length of the record, such as, sampling frequency 6s, time scale 1s, the record length is set to 0.6kpts, then the collection of 100 points per second.

## Syntax

SCOPe:RECOrd:LENGth <0.6|6|60|600>

## Returns

<0.6|6|60|600>

## Query syntax

SCOPe:RECOrd:LENGth?

## Example

SCOPe:RECOrd:LENGth 6

## SCOPe:SAMPLe:MODE <NORMAl|PEAK>

This command is used to set sampling mode of Oscilloscope.

NORMAL: Acquisition of data points by equal interval mode

PEAK: Acquisition of data points by peak-to-peak mode

### Syntax

SCOPE:SAMPLE:MODE <NORMAL|PEAK>

### Argument

<NORMAL|PEAK>

### Query syntax

SCOPE:SAMPLE:MODE?

### Example

SCOPE:RECORD:LENGTH 6

## SCOPE:DATA:TAG?

Queries the sample data identification of the oscilloscope.

### Syntax

SCOPE:DATA:TAG?

### Returns

Return: <NR1>,<NR1> ,<NR1> ,<NR1> ,<NR1>

The first one is the starting point of the display

The second one shows the end time point

The third one is the data start time point

The fourth is the data end time point

The fifth is the data trigger time point

### Example

SCOPE:DATA:TAG?

## SCOPE:PRINT:TYPE <OFF|POST|RAW|BOTH>

Set the data type for the oscilloscope's printout.

### Syntax

SCOPE:PRINT:TYPE <OFF|POST|RAW|BOTH>

### Argument

<OFF|POST|RAW|BOTH>

### Query syntax

SCOPE:PRINT:TYPE?

Example

SCOP:PRIN:TYPE OFF

## Chapter12 SOURce Subsystem (Source)

### [SOURce:]FUNCTion <CPD1>[,CPD2]

This command is used to set and query the working mode of the power supply.

Syntax:

FUNCTion <CPD1>[,CPD2]

Arguments:

CPD1:DC|AC|DCAC|ACDC

CPD2:CH1|CH2|CH3

CPD1: No DC or DCAC under three-phase

CPD2: Select a channel, this parameter needs to be input only in multi-channel mode

Query syntax:

FUNCTion? [CH1|CH2|CH3]

Returns:

<CPD1>:DC|AC|DCAC|ACDC

<CPD2>:CH1|CH2|CH3

\*RST:

AC

Example

```

FUNC AC           //Set the instrument work mode to AC mode
FUNC AC,CH1      //Set the CH1 to AC mode in multi-channel mode.
FUNC? CH1        //Query the channel 1 work mode
    
```

### [SOURce:]FUNCTion:MODE <CPD>

This command is used to set and query the functional mode of the power supply.

Syntax:

FUNCTion:MODE <mode>

Arguments:

NORMal|LIST|SWEep

Query syntax:

FUNCTion:MODE?

Returns:

NORMal|LIST|SWEep

\*RST:

NORMal

Example

FUNC:MODE LIST

### **[SOURce:]CURRent:PROTection:RMS <NRf+> [,CH1|CH2|CH3]**

Set the RMS current protection value of the power supply.

Note: the second parameter [,CH1|CH2|CH3] is optional and only valid in multi-channel mode.

Syntax:

CURRent:PROTection:RMS <NRf+> [,CH1|CH2|CH3]

Arguments:

MAXimum|MINimum|DEFault

Query syntax:

CURRent:PROTection:RMS? [CH1|CH2|CH3],[MAXimum|MINimum|DEFault]

Returns:

MAXimum|MINimum|DEFault

Example

```
CURR:PROT:RMS 30 //Set the RMS protection level to 30A
CURR:PROT:RMS 10,1 // Set the CH1 RMS protection level to 30A under
multi-channel mode
CURR:PROT:RMS? //Query the RMS protection level
CURR:PROT:RMS? 1 //Query the CH1 RMS protection level
```

### **[SOURce:]CURRent:PROTection:DELay <NRf+> [,CH1|CH2|CH3]**

Set the RMS current protection delay time, the unit is: s

Syntax:

CURRent:PROTection:DELay <NRf+> [,CH1|CH2|CH3]

Arguments:

MAXimum|MINimum|DEFault

Query syntax:

CURRent:PROTection:DELay? [CH1|CH2|CH3],[MAXimum|MINimum|DEFault]

Returns:

MAXimum|MINimum|DEFault

Example

CURR:PROT:DEL 0.5

CURR:PROT:DEL 10,1

### **[SOURce:]CURRent:PROTection:DELay? [CH1|CH2|CH3],[MAXimum|MINimum|DEFault]**

Query the RMS current protection delay time.

Note: both parameters of this query command are optional.

Syntax:

CURRent:PROTection:DELay? [CH1|CH2|CH3],[MAXimum|MINimum|DEFault]

Arguments:

MAXimum|MINimum|DEFault

Returns:

MAXimum|MINimum|DEFault

Example

CURR:PROT:DEL?

CURR:PROT:DEL? MAX|MIN

CURR:PROT:DEL? 1, MAX|MIN

### **[SOURce:]CURRent:PROTection:MODE <CPD> [,CH1|CH2|CH3]**

This command sets and queries the mode of RMS current protection.

SHUTup: If the measured RMS current value is greater than or equal to the set value and greater than the protection delay time, protection is generated and the output of the machine is turned off.

LIMit: In the same way, when the protection is generated, the machine will still output with the Limit value.

Syntax:

CURRent:PROTection:MODE <CPD> [,CH1|CH2|CH3]

Arguments:

LIMit|SHUTup

Query syntax:

CURRent:PROTection:MODE? [CH1|CH2|CH3]

Returns:

LIMit|SHUTup

**[SOURce:]CURRENT:PROTECTION:PEAK <NRf+> [,CH1|CH2|CH3]**

This command sets the peak current protection value of the power supply.

Note: the second parameter [,CH1|CH2|CH3] is optional and only valid in multi-channel mode.

**Syntax:**

CURRENT:PROTECTION:PEAK <NRf+> [,CH1|CH2|CH3]

**Arguments:**

MAXimum|MINimum|DEFault

**Query syntax:**

CURRENT:PROTECTION:PEAK? [CH1|CH2|CH3],[MAXimum|MINimum|DEFault]

**Returns:**

MAXimum|MINimum|DEFault

**Example**

CURR:PROT:PEAK 30

CURR:PROT:PEAK 10,1

**[SOURce:]CURRENT:PROTECTION:PEAK?  
[CH1|CH2|CH3],[MAXimum|MINimum|DEFault]**

This command is used to query the peak current protection value of the power supply.

Note: both parameters of this query command are optional.

**Syntax:**

CURRENT:PROTECTION:PEAK? [CH1|CH2|CH3],[MAXimum|MINimum|DEFault]

**Arguments:**

MAXimum|MINimum|DEFault

**Returns:**

MAXimum|MINimum|DEFault

**Example**

CURR:PROT:PEAK?

CURR:PROT:PEAK? MAX|MIN

CURR:PROT:PEAK? 1,MAX|MIN

**[SOURce:]CURRENT:PROTECTION:PEAK:DELAY<NRf+>  
[,CH1|CH2|CH3]**

This command sets the peak current protection delay time, the unit is: s.

**Syntax:**

CURRent:PROTection:PEAK:DELay <NRf+> [,CH1|CH2|CH3]

**Arguments:**

MAXimum|MINimum|DEFault

**Query syntax:**

CURRent:PROTection:PEAK:DELay?  
[CH1|CH2|CH3],[MAXimum|MINimum|DEFault]

**Returns:**

MAXimum|MINimum|DEFault

**Example**

CURR:PROT:PEAK:DEL 0.5  
CURR:PROT:PEAK:DEL 10,1

## **[SOURce:]CURRent:PROTection:PEAK:DELay? [CH1|CH2|CH3],[MAXimum|MINimum|DEFault]**

This command queries the peak current protection delay time.

Note: both parameters of this query command are optional.

**Syntax:**

[SOURce]CURRent:PROTection:PEAK:DELay?  
[CH1|CH2|CH3],[MAXimum|MINimum|DEFault]

**Arguments:**

MAXimum|MINimum|DEFault

**Returns:**

MAXimum|MINimum|DEFault

**Example**

CURRent:PROTection:PEAK:DELay?  
CURRent:PROTection:PEAK:DELay? MAX|MIN  
CURRent:PROTection:PEAK:DELay? 1, MAX|MIN

## **[SOURce:]CURRent:LIMit:HIGH <NRf+> [,CH1|CH2|CH3]**

This command sets and queries the upper limit of RMS current.

Note: the second parameter is optional and only valid in multi-channel mode.

**Syntax:**

CURRent:LIMit:HIGH <NRf+> [,CH1|CH2|CH3]

**Arguments:**

MAXimum|MINimum|DEFault

**Query syntax:**

CURRent:LIMit:HIGH? [CH1|CH2|CH3],[MAXimum|MINimum|DEFault]

**Returns:**

MAXimum|MINimum|DEFault

**Example:**

```
CURR:LIMit:HIGH 5           //Set the power supply current limit value to 5A.
CURR:LIMit:HIGH 5 ,CH1     //In multi-channel mode, set the current limit value
                             of channel 1 to 5A.
```

## **[SOURce:]CURRent:LIMit:LOW <NRf+> [,CH1|CH2|CH3]**

This command sets and queries the lower limit of RMS current.

Note: the second parameter is optional and only valid in multi-channel mode.

**Syntax:**

CURRent:LIMit:LOW <NRf+> [,CH1|CH2|CH3]

**Arguments:**

MAXimum|MINimum|DEFault

**Query syntax:**

CURRent:LIMit:LOW? [CH1|CH2|CH3],[MAXimum|MINimum|DEFault]

**Returns:**

MAXimum|MINimum|DEFault

**Example:**

```
CURR:LIMit:LOW 1           //Set the current lower limit to 1A
CURR:LIMit:LOW 1 ,1       //Under multi-channel mode, set the current lower
                             limit to 1A
```

## **[SOURce:]CURRent[:LEVel][:IMMediate][:AMPLitude][:AC] <NRf+>[,NRf+][,NRf+]**

Set and query the upper limit of RMS current, which has the same function as the command [SOURce:]CURRent:LIMit:HIGH <NRf+> [,CH1|CH2|CH3].

**Syntax:**

CURRent[:LEVel][:IMMediate][:AMPLitude][:AC] <NRf+>[,NRf+][,NRf+]

**Arguments:**

<NRf+>

MAXimum|MINimum|DEFault

Query syntax:

CURRent[:LEVeI][:IMMediate][:AMPLitude][:AC]?

Returns:

MAXimum|MINimum|DEFault

Related syntax:

[SOURce:]CURRent:LIMit:HIGH <NRf+> [,CH1|CH2|CH3]

Example:

```
CURR 30 //Under single mode, set the current RMS to 30A
CURR 30,20,10 //Under multi-channel or 3-three phase mode, set the current
RMS to 30A,20A,10A
```

## **[SOURce:]CURRent[:LEVeI][:IMMediate][:AMPLitude]:DC <NRf+>,[NRf+],[NRf+]**

DC current limit value setting command in normal mode.

<NRf+>: DC current setting value.

Syntax:

CURRent[:LEVeI][:IMMediate][:AMPLitude]:DC <NRf+>,[NRf+],[NRf+]

Query syntax:

CURRent[:LEVeI][:IMMediate][:AMPLitude]:DC?

Returns

<NRf+>

Example:

CURRent:DC 30

## **[SOURce:]VOLTage[:LEVeI][:IMMediate][:AMPLitude][:AC] <NRf+>,[NRf+],[NRf+]**

This command is used to set and query the AC voltage RMS.

In the three-phase mode, the three parameters of the command will be set to the corresponding A/B/C three-phase. If the command contains one Arguments, the A/B/C will be set at the same time (in this case, whether it is balanced or unbalanced,all so).

Syntax:

VOLTage[:LEVeI][:IMMediate][:AMPLitude][:AC] <NRf+>,[NRf+],[NRf+]

**Arguments:**

MAXimum|MINimum|DEFault

**Query syntax:**

VOLTage[:LEVel][:IMMediate][:AMPLitude][:AC]? [MAXimum|MINimum|DEFault]

**Returns:**

MAXimum|MINimum|DEFault

**Example:**

VOLTage 220 //Under single mode, set the Voltage RMS to 220V  
 VOLTage 20,30,40 //Under multi-channel or 3-three phase mode, set the current RMS to 30A,20A,10A

## [SOURce:]VOLTage:LIMit:HIGH <NRf+> [,CH1|CH2|CH3]

This command sets and query the upper limit of RMS voltage.

Note: the second parameter is optional and only valid in multi-channel mode.

**Syntax:**

VOLTage:LIMit:HIGH <NRf+> [,CH1|CH2|CH3]

**Arguments:**

MAXimum|MINimum|DEFault

**Query syntax:**

VOLTage:LIMit:HIGH? [CH1|CH2|CH3],[MAXimum|MINimum|DEFault]

**Returns:**

MAXimum|MINimum|DEFault

**Example:**

VOLTage:LIMit:HIGH 300 //Set the voltage upper limit to 300V  
 VOLTage:LIMit:HIGH 300,1 //Set the voltage upper limit of CH1 or A phase to 300V  
 VOLTage:LIMit:HIGH? //Query the voltage upper limit

## [SOURce:]VOLTage:LIMit:LOW <NRf+> [,CH1|CH2|CH3]

This command sets and query the lower limit of RMS voltage.

Note: the second parameter is optional and only valid in multi-channel mode.

**Syntax:**

VOLTage:LIMit:LOW <NRf+> [,CH1|CH2|CH3]

**Arguments:**

MAXimum|MINimum|DEFault

Query syntax:

VOLTage:LIMit:LOW? [CH1|CH2|CH3],[MAXimum|MINimum|DEFault]

Returns:

MAXimum|MINimum|DEFault

Example:

```
VOLTage:LIMit:LOW -11 //set the lower voltage to -11V
VOLTage:LIMit:LOW -11,1 //set lower voltage of CH1 to -11V
VOLTage:LIMit:LOW? //Query the lower volage setting
```

## **[SOURce:]PVOLTage[:LEVel][:IMMediate][:AMPLitude][:AC] <phase>,<NRf+>**

It is used to set and query the AC voltage of a certain phase in normal mode.

phase: phase identification.

NRf+: AC voltage setting value.

Syntax:

PVOLTage[:LEVel][:IMMediate][:AMPLitude][:AC] <phase>,<NRf+>

Arguments:

A|B|C

Query syntax:

PVOLTage[:LEVel][:IMMediate][:AMPLitude][:AC]? <phase>,[MAXimum|MINimum|DEFault]

Returns:

A|B|C,<NRf+>

Example:

```
PVOLTage B,300.0
PVOLTage B,MAX
PVOL? B
PVOL? B,MAX
```

## **[SOURce:]VOLTage[:LEVel][:IMMediate][:AMPLitude]:DC <NRf+>,[NRf+],[NRf+]**

DC voltage setting command in normal mode.

<NRf+>: DC voltage setting value.

Syntax:

VOLTage[:LEVel][:IMMediate][:AMPLitude]:DC <NRf+>,[NRf+],[NRf+]

Query syntax:

VOLTage[:LEVel][:IMMediate][:AMPLitude]:DC?

\*RST:

0V

Example

VOLTage:DC 300.0

VOLTage:DC?

VOLT:DC? MIN

## **[SOURce:]PVOLTage[:LEVel][:IMMediate][:AMPLitude]:DC <phase>,<NRf+>**

In normal mode, set and query the DC voltage value of a phase.

phase: phase identification.

NRf+: DC voltage setting value.

Syntax:

PVOLTage [:LEVel][:IMMediate][:AMPLitude]:DC <phase>,<NRf+>

Query syntax:

PVOLTage[:LEVel][:IMMediate][:AMPLitude]:DC? <phase> [MAXimum|MINimum|DEFAULT]

Example

PVOLTage:DC C,30.0

PVOLTage:DC? B

PVOL:DC? B,MIN

## **[SOURce:]VOLTage:SLOPe[:AC][:IMMediate] <NRf+>,[NRf+],[NRf+]**

This command is used to set and query the AC voltage slope in normal mode.

<NRf+>: AC voltage slope setting value

Syntax:

VOLTage:SLOPe[:AC][:IMMediate] <NRf+>,[NRf+],[NRf+]

Query syntax:

VOLTage:SLOPe[:AC][:IMMediate]? [MAXimum|MINimum|DEFAULT]

Example

VOLTage:SLOPe 300.0

VOLT:SLOP 300.0,500,800

VOLT:SLOP?  
 VOLT:SLOP? MAX

## **[SOURce:]PVOLtage:SLOPe[:IMMediate][:AC] <phase>,<NRf+>**

Set and query the AC voltage slope of a phase in normal mode.  
 phase: phase identification.  
 NRf+: AC voltage slope setting value.

Syntax:

PVOLtage:SLOPe[:IMMediate][:AC] <phase>,<NRf+>

Query syntax:

PVOLtage:SLOPe[:AC][:IMMediate]? <phase>,[MAXimum|MINimum|DEFault]

Example

PVOL:SLOP C,300.0  
 PVOL:SLOP?  
 PVOL:SLOP? C,MAX

## **[SOURce:]VOLTage:SLOPe[:IMMediate]:DC <NRf+>,[NRf+],[NRf+]**

This command is used to set and query the DC voltage slope in normal mode.  
 <NRf+>: DC voltage slope setting value

Syntax:

[SOURce]VOLTage:SLOPe[:IMMediate]:DC <NRf+>,[NRf+],[NRf+]

Query syntax:

VOLTage:SLOPe[:IMMediate]:DC? [MAXimum|MINimum| DEFault]

Example

VOLT:SLOP:DC 300.0  
 VOLT:SLOP:DC?  
 VOLT:SLOP:DC? MAX

## **[SOURce:]PVOLtage:SLOPe[:IMMediate]:DC <phase>,<NRf+>**

Set and query the DC voltage slope in normal mode.  
 Phase: phase identification.  
 NRf+: DC voltage slope setting value.

**Syntax:**

[SOURce]PVOLtage:SLOPe[:IMMediate]:DC <phase>,<NRf+>

**Query syntax:**

PVOLtage:SLOPe[:IMMediate]:DC? <phase>,[MAXimum|MINimum|DEFault]

**\*RST:**

10V/ms

**Example**

PVOL:SLOP:DC C,300.0

PVOL:SLOP:DC? C

PVOL:SLOP:DC? C,MAX

## **[SOURce:]FREQuency[:IMMediate] <NRf+>[,NRf+][,NRf+]**

This command is used to set and query the frequency value in normal mode.

<NRf+>: frequency setting value.

Note: in multi-channel, this command must carry three parameters to set at the same time, or use PFREquency to set a separate frequency.

**Syntax:**

FREQuency[:IMMediate] <NRf+>[,NRf+][,NRf+]

**Arguments:**

MAXimum|MINimum|DEFault

**Query syntax:**

FREQuency[:IMMediate]? [MAXimum|MINimum|DEFault]

**Returns:**

MAXimum|MINimum|DEFault

**\*RST:**

50Hz

**Example**

FREQuency 300.0

FREQuency?

## **[SOURce:]PFREQuency[:IMMediate] <phase>,<NRf+>**

Set and query the frequency value of a phase.

**Syntax:**

PFREquency[:IMMediate] <phase>,<NRf+>

Query syntax:

PFREquency[:IMMediate]? <phase>

Example

```
PFREquency A,300.0           //Set the frequency of phase A to 300.0Hz
PFREquency? A                //Query the frequency value of phase A
```

## **[SOURce:]FREQuency:SLOPe[:IMMediate] <NRf+>[,NRf+][,NRf+]**

This command is used to set and query the slope of the frequency in normal mode.

<NRf+>: frequency setting value.

Syntax:

FREQuency:SLOPe[:IMMediate] <NRf+>[,NRf+][,NRf+]

Query syntax:

FREQuency:SLOPe[:IMMediate]? <phase>

\*RST:

1000Hz/ms

Example

```
FREQuency:SLOPe 300.0
FREQ:SLOP 300.0
FREQ:SLOP? C
```

## **[SOURce:]PFREquency:SLOPe[:IMMediate] <phase>,<NRf+>**

Set and query the frequency slope of a phase in normal mode. Invalid in DC mode.

<NRf+>: frequency setting value

Syntax:

PFREquency:SLOPe[:IMMediate] <phase>,<NRf+>

Query syntax:

PFREquency:SLOPe[:IMMediate]? <phase>

\*RST:

1000Hz/ms

Example

```
PFRE:SLOP C,300.0
```

PFRE:SLOP? C

## **[SOURce:]POWER:LIMit:HIGH <NRf+> [,CH1|CH2|CH3]**

This command sets and queries the upper limit of power protection.

Note: the second parameter is optional and valid in multi-channel mode/three-phase.

Syntax:

POWER:LIMit:HIGH <NRf+> [,CH1|CH2|CH3]

Arguments:

MAXimum|MINimum|DEFault

Query syntax:

POWER:LIMit:HIGH? [CH1|CH2|CH3][,MAXimum|MINimum|DEFault]

Example

POWER:LIMit:HIGH 20 //Set the upper limit of the power protection value to 20VA.

POWER:LIMit:HIGH 20,2 //Set the upper power limit of channel 2 to 20VA.

POWER:LIMit:HIGH? 1 //Query the power upper limit of channel 1.

## **[SOURce:]POWER:LIMit:LOW <NRf+> [,CH1|CH2|CH3]**

This command sets and queries the lower limit of power protection.

Note: the second parameter is optional and valid in multi-channel mode/three-phase.

Syntax:

POWER:LIMit:LOW <NRf+> [,CH1|CH2|CH3]

Arguments:

MAXimum|MINimum|DEFault

Query syntax:

POWER:LIMit:LOW? [CH1|CH2|CH3][,MAXimum|MINimum|DEFault]

Example

POWER:LIMit:LOW 10 //Set the lower limit of the power protection value to 10VA.

POWER:LIMit:LOW 10,1 //Set the lower power limit of channel 1 to 10VA.

POWER:LIMit:LOW? 1 //Query the lower power limit of channel 1.

## **[SOURce:] POWER:LIMit:DELay <NRf+> [,CH1|CH2|CH3]**

This command sets and queries the power protection delay time, the unit is: s.

Syntax:

POWER:LIMit:DELay <NRf+> [,CH1|CH2|CH3]

**Arguments:**

MAXimum|MINimum|DEFault

**Query syntax:**

POWER:LIMit:DELay? [CH1|CH2|CH3][,MAXimum|MINimum|DEFault]

**Example**

```
POWER:LIMit:DELay 3 //The delay time of over power protection is set to 3s
POWER:LIMit:DELay 3,2 //Set the over-power protection delay time of
channel 2 to 3 seconds.
POWER:LIMit:DELay? 2 // Query the over-power protection delay time of
channel 2.
```

## [SOURce:]ANGLE:DIFFerence[:IMMediate] <type>,<NRf+>

This command is used to set and query the angle difference in Normal mode.

<type>: angle difference type information

BA: angle difference between B and A

CA: angle difference between C and A

<NRf+>: angle difference setting value

Note: meaningful in three-phase unbalanced mode.

**Syntax:**

ANGLE:DIFFerence[:IMMediate] <type>,<NRf+>

**Query syntax:**

ANGLE:DIFFerence[:IMMediate]? <type>, [MAXimum|MINimum|DEFault]

**Example**

```
ANGL:DIFFerence BA,300.0 //Set the angle difference between B and A to
300.0°.
ANGL:DIFFerence? CA //Query the angle difference between C and A.
```

## [SOURce:]WAVE[:IMMediate] <wave>,[wave],[wave]

This command is used to set and query the waveform in Normal mode.

<wave>: waveform index value.

- Sine
- Square
- Saw
- Triangle
- Trapezoid
- Clipped-sine

**Syntax:**

WAVE[:IMMEDIATE] <wave>,[wave],[wave]

**Query syntax:**

WAVE?

**Example**

```
WAVE SIN           //Set the waveform to Sine in the present mode.
WAVE?             //Query the waveform in present mode.
```

## **[SOURce:]PWAVE[:IMMEDIATE] <phase>,<wave>**

This command is used to set and query the waveform of specified phase in Normal mode.

<phase>: phase index value.

<wave>: waveform index value.

- Sine
- Square
- Saw
- Triangle
- Trapezoid
- Clipped-sine

**Syntax:**

PWAVE[:IMMEDIATE] <phase>,<wave>

**Query syntax:**

PWAVE? <phase>]

**\*RST:**

0-Sine

**Example**

```
PWAV C,"Sine"     //Set the waveform of phase C to Sine.
PWAV? C          //Query the waveform of C phase.
```

## **[SOURce:]DIMMING[:STATE] <CPD>[,CH1|CH2|CH3]**

This command is used to set and query the dimming function switch.

**Syntax:**

DIMMING[:STATE] <CPD>[,CH1|CH2|CH3]

**Arguments:**

0|OFF|1|ON

Query syntax:

DIMMing[:STATe]? [CH1|CH2|CH3]

Returns:

0|1

Example:

DIMMing 1,2 //enable the dimming function of CH2.  
 DIMMing? 1 //Query the dimming function status of CH1

## **[SOURce:]DIMMing:EDGE <CPD>[,CH1|CH2|CH3]**

This command is used to set and query the dimming edge.

Syntax:

DIMMing:EDGE <CPD>[,CH1|CH2|CH3]

Arguments:

FRONT|BACK

Query syntax:

DIMMing:EDGE? [CH1|CH2|CH3]

Returns:

FRONT|BACK

## **[SOURce:]DIMMing:PHASe <NRf>[,CH1|CH2|CH3]**

This command is used to set and query the dimming phase.

Syntax:

DIMMing:PHASe <NRf>[,CH1|CH2|CH3]

Arguments:

MAXimum|MINimum|DEFault

Query syntax:

DIMMing:PHASe? [CH1|CH2|CH3]

Returns:

MAXimum|MINimum|DEFault

## **[SOURce:]EXTErn:PROGrama[:STATe] <CPD>**

This command is used to set and query the external control state.

Syntax:

EXTErn:PROGrama[:STATe] <CPD>

**Arguments:**

0|OFF|1|ON

**Query syntax:**

EXTern:PROGrama[:STATe]?

**Example**

EXT:PROG ON

**[SOURce:]EXTern:PROGrama:MODE <CPD>**

This command is used to set and query the external programming mode.

**Syntax:**

EXTern:PROGrama:MODE &lt;CPD&gt;

**Arguments:**

AM|INSTant

**Query syntax:**

EXTern:PROGrama:MODE?

**Example**

EXT:PROG:MODE INSTant

**[SOURce:]EXTern:MONitor:PHASe <phase>**

This command is used to set which phase to monitor, when three phases and multiple channels are used.

**Syntax:**

EXTern:MONitor:PHASe &lt;phase&gt;

**Arguments:**

A|B|C

**Query syntax:**

EXTern:MONitor:PHASe?

**Example**

```
EXTern:MONitor:PHASe A           //monitor A phase
EXTern:MONitor:PHASe?           //query the phase to monitor
```

**[SOURce:]EXTern:PROGrama:VOLTage:RANGe <range>**

This command is used to set the voltage level for external simulation. Either 50V/1 or 100V/1 can be selected.

This setting is valid for both external analog and external voltage monitoring.

**Syntax:**

```
EXTErn:PROGrama:VOLTage:RANGe <range>
```

**Arguments:**

```
50V/1V|100V/1V
```

**Query syntax:**

```
EXTErn:PROGrama:VOLTage:RANGe?
```

**Example:**

```
EXTErn:PROGrama:VOLTage:RANGe 50V/1V
```

```
EXTErn:PROGrama:VOLTage:RANGe?
```

**[SOURce:]CONFIgure:HARMonic:THD:FORMula <CPD>**

This command is used to set and query the calculation formula of harmonic distortion. Whether to use the fundamental wave (1st order) component data as the denominator f% or all the harmonic measurement data as the denominator r%.

**Syntax:**

```
CONFIgure:HARMonic:THD:FORMula <CPD>
```

**Arguments:**

```
FUNDamental|TOTal
```

**Query syntax:**

```
CONFIgure:HARMonic:THD:FORMula?
```

**Example**

```
CONF:HARM:THD:FORM TOTAL //Set the harmonic measurement formula to r%
```

**[SOURce:]CONFIgure:HARMonic:TABLE:TYPE <CPD>**

This command is used to set and query the display type of the harmonic distortion table.

**Syntax:**

```
CONFIgure:HARMonic:TABLE:TYPE <CPD>
```

**Arguments:**

```
<ALL|EVEN|ODD>
```

**Query syntax:**

```
CONFIgure:HARMonic:TABLE:TYPE?
```

## Example

```
CONF:HARM:TABL:TYPE ODD
```

## **[SOURce:]CONFigure:HARMonic:TABLE:SElect <CPD>**

This command is used to set and query the data type of the harmonic distortion list, whether it is voltage harmonic or current harmonic.

### Syntax:

```
CONFigure:HARMonic:TABLE:SElect <CPD>
```

### Arguments:

```
<U|I>
```

### Query syntax:

```
CONFigure:HARMonic:TABLE:SElect?
```

## Example

```
CONF:HARM:TABL:SEL U //Select to display voltage harmonic data.
```

## **[SOURce:]CONFigure:HARMonic:TABLE:PHASe[:MODE] <CPD>**

This command is used to set the phase of harmonic waveform selection B or C phase to lead or lag phase A.

### Syntax:

```
[SOURce:]CONFigure:HARMonic:TABLE:PHASe[:MODE] <CPD>
```

### Arguments:

```
< BEFore|AFTer >
```

### Query syntax:

```
[SOURce:]CONFigure:HARMonic:TABLE:PHASe[:MODE]?
```

## Example

```
CONF:HARM:TABL:PHAS BEF
```

## **[SOURce:]VOLTage:PROTection:PEAK <NRf+> [A|B|C|CH1|CH2|CH3]**

This command sets the peak voltage protection point.

### Syntax:

```
[SOURce:]VOLTage:PROTection:PEAK <NRf+> [A|B|C|CH1|CH2|CH3]
```

### Arguments:

```
MAXimum|MINimum|DEFault
```

### Query syntax:

```
[SOURce:]VOLTage:PROTection:PEAK?
```

[A|B|C|CH1|CH2|CH3][,MAXimum|MINimum|DEFault]

Example:

VOLTage:PROTection:PEAK 300

### **[SOURce:]VOLTage:PROTection:DELay <NRf+> [A|B|C|CH1|CH2|CH3]**

This command sets the peak voltage protection delay.

Syntax:

[SOURce:]VOLTage:PROTection:DELay <NRf+> [A|B|C|CH1|CH2|CH3]

Arguments:

MAXimum|MINimum|DEFault

Query syntax:

[SOURce:]VOLTage:PROTection:DELay?  
[A|B|C|CH1|CH2|CH3][,MAXimum|MINimum|DEFault]

Example:

VOLTage:PROTection:DELay 5

### **[SOURce:]CURRent:INRush:MODE <CPD>**

Set the inrush current measurement mode.

Syntax:

[SOURce:]CURRent:INRush:MODE <CPD>

Arguments:

NORMal|CUSTom|DISable

Query syntax:

[SOURce:]CURRent:INRush:MODE?

Example

CURRent:INRush:MODE DISable

### **[SOURce:]CURRent:INRush:DELay <NRf+>**

Set the delay time for measuring inrush current.

Syntax:

[SOURce:]CURRent:INRush:DELay <CPD>

Arguments:

MAXimum|MINimum

Query syntax:

```
[SOURce:]CURRent:INRush:DELay?
```

Example

```
[SOURce:]CURRent:INRush:DELay 10
```

## **[SOURce:]CURRent:INRush:HOLD < NRf+>**

Set the duration for measuring inrush current (effective measurement time window, starting from the end of the delay period).

Syntax:

```
[SOURce:]CURRent:INRush:HOLD <CPD>
```

Arguments:

```
MAXimum|MINimum
```

Query syntax:

```
[SOURce:]CURRent:INRush:HOLD?
```

Example

```
[SOURce:]CURRent:INRush:HOLD 10
```

## **[SOURce:]VOLTage:LINE:MODE <mode>**

Set the system voltage setting mode.

Syntax:

```
[SOURce:]VOLTage:LINE:MODE <mode>
```

Arguments:

```
LN|LL
```

Query syntax:

```
[SOURce:]VOLTage:LINE:MODE?
```

Example

```
VOLTage:LINE:MODE LN
```

## **[SOURce:]VOLTage:LINE:VAB <value>**

This command is used to set the A-B line voltage. It is effective when the [SOURce:]VOLTage:LINE:MODE <mode> command is set to LL.

Syntax:

```
[SOURce:]VOLTage:LINE:VAB <value>
```

Arguments:

```
MAXimum|MINimum
```

Query syntax:

[SOURce:]VOLTage:LINE:VAB?

Example

VOLTage:LINE:VAB 30

## **[SOURce:]VOLTage:LINE:VBC <value>**

This command is used to set the B-C line voltage. It is effective when the [SOURce:]VOLTage:LINE:MODE <mode> command is set to LL.

Syntax:

[SOURce:]VOLTage:LINE:VBC <value>

Arguments:

MAXimum|MINimum

Query syntax:

[SOURce:]VOLTage:LINE:VBC?

Example

VOLTage:LINE:VBC 30

## **[SOURce:]VOLTage:LINE:VCA <value>**

This command is used to set the C-A line voltage. It is effective when the [SOURce:]VOLTage:LINE:MODE <mode> command is set to LL.

Syntax:

[SOURce:]VOLTage:LINE:VCA <value>

Arguments:

MAXimum|MINimum

Query syntax:

[SOURce:]VOLTage:LINE:VCA?

Example

VOLTage:LINE:VCA 30

## **[SOURce:]VOLTage:LINE:APPLY:APPRoximate**

This command is used to set the current approximate setpoint.

Syntax:

[SOURce:]VOLTage:LINE:APPLY:APPRoximate

Arguments:

MAXimum|MINimum

Query syntax:

[SOURce:]VOLTage:LINE:APPRoximate?

Example

V VOLT:LINE:APPLY:APPR

---

## Chapter13 Output Commands (Source)

---

### **OUTPut[:STATe] <CPD>**

This command sets and query the output state of the power supply.

Syntax:

```
OUTPut[:STATe] <CPD>
```

Arguments:

```
0|OFF|1|ON
```

Query syntax:

```
OUTPut[:STATe]?
```

Returns:

```
0|OFF|1|ON
```

Example

```
OUTP ON //Turn on the power output.
```

### **OUTPut:PROTection:CLEAr**

This command is used to clear the protection status.

Syntax:

```
OUTPut:PROTection:CLEAr
```

Example

```
OUTP:PROT:CLE
```

### **OUTPut:PROTection:WDOG[:STATe] <CPD>**

This command enables or disables the state of the communication watchdog.

Syntax:

```
OUTPut:PROTection:WDOG[:STATe] <CPD>
```

Arguments:

```
0|OFF|1|ON
```

Returns:

```
0|1
```

Example

```
OUTP:PROT:WDOG ON
```

## OUTPut:PROTection:WDOG:DELaY <NRf+>

This command sets and queries the time of the communication watchdog, unit: s.

### Syntax:

OUTPut:PROTection:WDOG:DELaY <NRf+>

### Arguments:

MINimum|MAXimum|DEFault

### Query syntax:

OUTPut:PROTection:WDOG:DELaY?

### Returns:

MINimum|MAXimum|DEFault

### Example

OUTPut:PROTection:WDOG:DELaY 100

## OUTPut:IMPedance[:STATe] <CPD>[,A|B|C|CH1|CH2|CH3]

This command is used to set and query the output state of the impedance.

0|OFF indicates that the function is turned off.

1|ON indicates that the function is turned on.

A|B|C|CH1|CH2|CH3 means to specify a phase or a channel in three-phase mode or multi-channel mode.

### Syntax:

OUTPut:IMPedance[:STATe] <CPD>[,A|B|C|CH1|CH2|CH3]

### Arguments:

0|OFF|1|ON

### Query syntax:

OUTPut:IMPedance[:STATe]? [A|B|C|CH1|CH2|CH3]

### Returns:

0|OFF|1|ON

### Example

OUTP:IMP ON //Turn on the output impedance.

OUTP:IMP OFF,A //Turn off the output impedance function of phase A.

## OUTPut:IMPedance:RESistance:LEVel <NRf+>[,A|B|C|CH1|CH2|CH3]

Set and query the resistance value of the output impedance. It is valid after the output impedance function is turned on.

**Syntax:**

OUTPut:IMPedance:RESistance:LEVel <NRf+>[,A|B|C|CH1|CH2|CH3]

**Arguments:**

MINimum|MAXimum|DEFault

**Query syntax:**

OUTPut:IMPedance:RESistance:LEVel? [A|B|C|CH1|CH2|CH3]

**Returns:**

MINimum|MAXimum|DEFault

**Example:**

OUTP:IMP:RES:LEV 10  
OUTP:IMP:RES:LEV 100,A

## **OUTPut:IMPedance:INDuctance:LEVel <NRf>[,A|B|C|CH1|CH2|CH3]**

This command is used to set and query the output inductance value.

**Syntax:**

OUTPut:IMPedance:INDuctance:LEVel <NRf>[,A|B|C|CH1|CH2|CH3]

**Arguments:**

MINimum|MAXimum|DEFault

**Query syntax:**

OUTPut:IMPedance:INDuctance:LEVel? [A|B|C|CH1|CH2|CH3]

**Returns:**

MINimum|MAXimum|DEFault

**Example**

OUTP:IMP:IND:LEV 10  
OUTP:IMP:IND:LEV 5,A

## **OUTPut:OFF:MODE <CPD>**

This command is used to set the output mode when the power output is OFF.

OPENz: disconnect the output relay and the output terminal is in a high-impedance state.

HIGHz: the output relay is closed and the output terminal is in a high-impedance state.

SHORT: the output terminal L and N are shorted.

**Syntax:**

```
OUTPut:OFF:MODE <CPD>
```

**Arguments:**

```
OPENz|HIGHz|SHORT
```

**Example:**

```
OUTP:OFF:MODE SHORT //Set the output terminals L and N to be shorted  
when the machine is OFF.
```

**OUTPut:SHORT:DELAy <NRf+>**

This command is used to set the instrument short circuit relay delay time.

Note: The time unit is ms

Single-phase, three-phase, reverse phase, and multi-channel each store one copy of data

Single-phase, reverse phase: [0~100]

Three-phase, multi-channel: [20~100]

**Syntax:**

```
OUTPut:SHORT:DELAy <NRf+>
```

**Arguments:**

```
MINimum|MAXimum|DEFault
```

**Query syntax:**

```
OUTPut:SHORT:DELAy?
```

**Returns:**

```
MINimum|MAXimum|DEFault
```

**Example:**

```
OUTP:ON:PHAS:MODE IMM
```

**OUTPut:ON:PHASe:MODE <CPD>**

This command is used to set and query the phase control mode when the power output is turned on:

PHASe: when the power is turned on, the output starts at the set phase angle

IMMEDIATE: the output starts at phase 0 when the machine is ON

SLOPe: The output starts with a set slope value when the machine is on.

**Syntax:**

```
OUTPut:ON:PHASe:MODE <CPD>
```

**Argument:**

```
PHASe|IMMEDIATE|SLOPe
```

Query syntax:

OUTPut:ON:PHASe:MODE?

Returns:

PHASe|IMMEDIATE|SLOPe

Example

OUTP:ON:PHAS:MODE IMM

## **OUTPut:ON:PHASe:LEVel <NRf+>**

This command is used to set and query the starting phase angle when the power output is turned on.

Syntax:

OUTPut:ON:PHASe:LEVel <NRf+>

Arguments:

MINimum|MAXimum|DEFault

Query syntax:

OUTPut:ON:PHASe:LEVel?

Returns:

MINimum|MAXimum|DEFault

Example

OUTP:ON:PHAS:LEV 30

## **OUTPut:ON:SLOPe:LEVel <NRf+>**

Sets the value of the slope at which the instrument outputs ON. When the ON/OFF phase mode is set to SLOPe, the instrument will start outputting at that slope at the moment of ON.

Syntax:

OUTPut:ON:SLOPe:LEVel <NRf+>

Arguments:

MINimum|MAXimum|DEFault

Query Syntax:

OUTPut:ON:SLOPe:LEVel?

Returns:

MINimum|MAXimum|DEFault

Example:

```
OUTPut:ON:SLOPe:LEVeL 200
```

## **OUTPut:OFF:SLOPe:LEVeL <NRf+>**

Sets the value of the slope at which the instrument outputs OFF. When the ON/OFF phase mode is set to SLOPe, the instrument will start outputting at that slope at the moment of OFF.

Syntax:

```
OUTPut:OFF:SLOPe:LEVeL <NRf+>
```

Arguments:

```
MINimum|MAXimum|DEFault
```

Query Syntax:

```
OUTPut:OFF:SLOPe:LEVeL?
```

Returns:

```
MINimum|MAXimum|DEFault
```

Example:

```
OUTPut:OFF:SLOPe:LEVeL 100
```

## **OUTPut:OFF:PHASe:MODE <CPD>**

This command is used to set and query the phase control mode when the power output is turned off:

PHASe: when the power output is OFF, the output will be turned off at the set phase angle

IMMEDIATE: when the power output is OFF, the output is turned off at 0 phase angle

Slope: The output starts with a set slope value when the machine is on.

Syntax:

```
OUTPut:OFF:PHASe:MODE <CPD>
```

Arguments:

```
PHASe|IMMEDIATE|SLOPe
```

Query syntax:

```
OUTPut:OFF:PHASe:MODE?
```

Returns:

```
PHASe|IMMEDIATE|SLOPe
```

Example

```
OUTP:OFF:PHAS:MODE PHAS
```

## **OUTPut:OFF:PHASe:LEVel <NRf+>**

This command is used to set and query the phase angle when the power output is turned off.

### Syntax:

OUTPut:OFF:PHASe:LEVel <NRf+>

### Arguments:

MINimum|MAXimum|DEFault

### Query syntax:

OUTPut:OFF:PHASe:LEVel?

### Returns:

MINimum|MAXimum|DEFault

### Example

OUTP:OFF:PHAS:LEV 45

## **OUTPut:BALance[:STATe] <CPD>**

In the three-phase mode, it is used to set and query the state of the output balance mode.

### Syntax:

OUTPut:BALance[:STATe] <CPD>

### Arguments:

0|OFF|1|ON

### Query syntax:

OUTPut:BALance[:STATe]?

### Returns:

0|OFF|1|ON

### Example

OUTP:BAL ON

---

## Chapter14 SENSE Commands (Source)

---

### **SENSe[:REMOte][:STATe] <CPD>**

This command enables or disables the sense function.

Syntax:

```
SENSe[:REMOte][:STATe] <CPD>
```

Arguments:

```
<OFF|ON|0|1>
```

Default value:

```
0|OFF
```

Query syntax:

```
SENSe[:REMOte][:STATe]?
```

Returns:

```
<OFF|ON|0|1>
```

Example

```
SENS ON
```

### **SENSe:FILTer[:STATe] <CPD>**

This command sets and queries the state of meter filter switch.

Syntax:

```
SENSe:FILTer[:STATe] <CPD>
```

Arguments:

```
0|OFF|1|ON
```

Query syntax:

```
SENSe:FILTer[:STATe]?
```

Returns:

```
0|OFF|1|ON
```

Example

```
SENSe:FILT OFF
```

### **SENSe:FILTer:LEVel <CPD>**

This command is used to set and query the filter level of the meter.

**Syntax:**

```
SENSe:FILTer:LEVel <CPD>
```

**Arguments:**

```
SLOW|MEDIUM|FAST
```

**Query syntax:**

```
SENSe:FILTer:LEVel?
```

**Returns:**

```
SLOW|MEDIUM|FAST
```

**Example**

```
SENS:FILT:LEV FAST
```

**SENSe:LOOP:SPEed <CPD>**

This command is used to set and query the loop speed.

**Syntax:**

```
SENSe:LOOP:SPEed <speed>
```

**Arguments:**

```
HIGH|LOW
```

**Default value:**

```
HIGH
```

**Query syntax:**

```
SENSe:LOOP:SPEed?
```

**Returns:**

```
HIGH|LOW
```

**Example**

```
SENS:LOOP:SPE LOW
```

**SENSe:EXTeRnal:FREQuency <CPD> [CH1, CH2, CH3]**

This command is used to set and query the external frequency lock function.  
the second parameter is optional and only valid in multi-channel mode.

**Syntax:**

```
SENSe:EXTeRnal:FREQuency <CPD> [CH1, CH2, CH3]
```

**Arguments:**

OFF|FREQuency|PHASe

**Query syntax:**

SENSe:EXTernal:FREQuency?

**Returns:**

OFF|FREQuency|PHASe

**Example:**

SENS:EXT:FREQ OFF

## **SENSe:EXTernal:FREQuency:OFFSet:HIGH <NRf>,[CH1, CH2, CH3]**

Set and query the frequency upper limit value of the external frequency lock function. the second parameter is optional and only valid in multi-channel mode.

Meaning: when the external frequency lock function is turned on, and the external frequency of the machine is within the current set frequency range, the external frequency will be used, otherwise the frequency set by the user will be used for output.

**Syntax:**

SENSe:EXTernal:FREQuency:OFFSet:HIGH <NRf>,[CH1, CH2, CH3]

**Arguments:**

MAXimum|MINimum|DEFault

**Query syntax:**

SENSe:EXTernal:FREQuency:OFFSet:HIGH? [CH1, CH2, CH3]

**Returns:**

<NRf>

**Example:**

SENS:EXT:FREQ:OFFS:HIGH 100

## **SENSe:EXTernal:FREQuency:OFFSet:LOW <NRf>,[CH1, CH2, CH3]**

Set and query the frequency lower limit value of the external frequency lock function. the second parameter is optional and only valid in multi-channel mode.

Meaning: when the external frequency lock function is turned on, and the external frequency of the machine is within the current set frequency range, the external frequency will be used, otherwise the frequency set by the user will be used for output.

**Syntax:**

```
SENSe:EXTernal:FREQuency:OFFSet:LOW <NRf>,[CH1, CH2, CH3]
```

**Arguments:**

```
MAXimum|MINimum|DEFault
```

**Query syntax:**

```
SENSe:EXTernal:FREQuency:OFFSet:LOW? [CH1, CH2, CH3]
```

**Returns:**

```
<NRf>
```

**Example:**

```
SENS:EXT:FREQ:OFFS:LOW 50
```

## **SENSe:EXTernal:FREQuency:PHASe <NRf>,[CH1, CH2, CH3]**

This command is used to set and query the angular difference between the machine and the external frequency.

Meaning: when the external frequency lock function is turned on, the output phase of the machine maintains a fixed angular difference with the external frequency.

**Syntax:**

```
SENSe:EXTernal:FREQuency:PHASe <NRf>,[CH1, CH2, CH3]
```

**Arguments:**

```
MAXimum|MINimum|DEFault
```

**Query syntax:**

```
SENSe:EXTernal:FREQuency:PHASe? [CH1, CH2, CH3]
```

**Returns:**

```
<NRf>
```

**Example:**

```
SENS:EXT:FREQ:PHAS 1
```

## **SENSe:EXTernal:FREQuency:EXCeption <CPD>,[CH1, CH2, CH3]**

Set and query the working mode when the external frequency is out of lock.

Meaning: when the external frequency lock function is turned on, the processing method when the external frequency is inconsistent with the set value.

STOP: turn off the output.

SETFrequency: output at the frequency set by the user.

**Syntax:**

```
SENSe:EXTernal:FREQuency:EXCeption <CPD>,[CH1, CH2, CH3]
```

**Arguments:**

```
STOP|SETFrequency
```

**Query syntax:**

```
SENSe:EXTernal:FREQuency:EXCeption?
```

**Returns:**

```
STOP|SETFrequency
```

**Example:**

```
SENS:EXT:FREQ:EXC STOP
```

**SENSe:EXTernal:FREQuency:SYNC <CPD>**

When setting the fiber synchronization slave, you can set this item, select local to refresh the amplitude in time, select fiber to refresh the amplitude following the host amplitude refresh change.

**Syntax:**

```
SENSe:EXTernal:FREQuency:SYNC <CPD>
```

**Arguments:**

```
LOCa||FIBer
```

**Query syntax:**

```
SENSe:EXTernal:FREQuency:SYNC?
```

**Returns:**

```
LOCa||FIBer
```

**Example:**

```
SENSe:EXTernal:FREQuency:SYNC FIBer
```

## Chapter15 FETCh & MEASure Commands (Source)

---

### FETCh[:SCALar]:CURRent[:AC]?

### MEASure[:SCALar]:CURRent[:AC]?

This command is used to read the effective value of current.

Note: this command parameter is optional. If there is no parameter, it will return the value of A, B, C three-phase by default.

Syntax:

```
FETCh[:SCALar]:CURRent? [A|B|C|CH1|CH2|CH3]
```

Arguments:

```
[A|B|C|CH1|CH2|CH3]
```

Returns:

```
<NRf>...
```

Example:

```
FETC:CURR? A
```

### FETCh[:SCALar]:CURRent:DC?

### MEASure[:SCALar]:CURRent:DC?

This command is used to read the DC component of current.

Note: this command parameter is optional. If there is no parameter, it will return the value of A, B, C three-phase by default.

Syntax:

```
FETCh[:SCALar]:CURRent? [A|B|C|CH1|CH2|CH3]
```

Arguments:

```
[A|B|C|CH1|CH2|CH3]
```

Returns:

```
<NRf>...
```

Example:

```
FETC:CURR:DC?
```

## **FETCh[:SCALar]:CURRent:AMPLitude:MAXimum:POSitive?**

### **MEASure[:SCALar]:CURRent:AMPLitude:MAXimum:POSitive?**

This command is used to read the positive peak value of current.

Note: this command parameter is optional. If there is no parameter, it will return the value of A, B, C three-phase by default.

Syntax:

```
FETCh[:SCALar]:CURRent:AMPLitude:MAXimum:POSitive?  
[A|B|C|CH1|CH2|CH3]
```

Arguments:

```
[A|B|C|CH1|CH2|CH3]
```

Returns:

```
<NRf>...
```

Example:

```
FETC:CURR:AMP:MAX:POS?
```

## **FETCh[:SCALar]:CURRent:AMPLitude:MAXimum:NEGative?**

### **MEASure[:SCALar]:CURRent:AMPLitude:MAXimum:NEGative?**

This command is used to read the negative peak value of current.

Note: this command parameter is optional. If there is no parameter, it will return the value of A, B, C three-phase by default.

Syntax:

```
FETCh[:SCALar]:CURRent:AMPLitude:MAXimum:NEGative?  
[A|B|C|CH1|CH2|CH3]
```

Arguments:

```
[A|B|C|CH1|CH2|CH3]
```

Returns:

```
<NRf>...
```

Example:

```
FETC:CURR:AMP:MAX:NEG?
```

## **FETCh[:SCALar]:CURRent:AMPLitude:MAXimum?**

### **MEASure[:SCALar]:CURRent:AMPLitude:MAXimum?**

This command is used to read the peak value of current.

Note: this command parameter is optional. If there is no parameter, it will return the value of A, B, C three-phase by default.

**Syntax:**

```
FETCh[:SCALar]:CURRent:AMPlitude:MAXimum? [A|B|C|CH1|CH2|CH3]
```

**Arguments:**

```
[A|B|C|CH1|CH2|CH3]
```

**Returns:**

```
<NRf>...
```

**Example:**

```
FETC:CURR:AMP:MAX?
```

## **FETCh[:SCALar]:CURRent:CFACtor?**

## **MEASure [:SCALar]:CURRent:CFACtor?**

This command is used to read the current crest factor values of A, B, C three-phase.

Note: this command parameter is optional. If there is no parameter, it will return the value of A, B, C three-phase by default.

**Syntax:**

```
FETCh[:SCALar]:CURRent:CFACtor? [A|B|C|CH1|CH2|CH3]
```

**Arguments:**

```
[A|B|C|CH1|CH2|CH3]
```

**Returns:**

```
<NRf>...
```

**Example:**

```
FETC:CURR:CFAC?
```

## **FETCh[:SCALar]:FREQUency?**

## **MEASure[:SCALar]:FREQUency?**

This command is used to read the frequency value.

Note: this command parameter is optional. If there is no parameter, it will return the value of A, B, C three-phase by default.

**Syntax:**

```
FETCh[:SCALar]:FREQUency? [A|B|C|CH1|CH2|CH3]
```

Arguments:

[A|B|C|CH1|CH2|CH3]

Returns:

<NRf>...

Example:

FETC[:SCAL]:FREQ?

## **FETCh[:SCALar]:POWer[:REAL]?**

## **MEASure[:SCALar]:POWer[:REAL]?**

This command is used to read the real power value.

Note: this command parameter is optional. If there is no parameter, it will return the value of A, B, C three-phase by default.

Syntax:

FETCh[:SCALar]:POWer [:REAL]? [A|B|C|CH1|CH2|CH3]

Arguments:

[A|B|C|CH1|CH2|CH3]

Returns:

<NRf>...

Example:

FETC:POWer?

## **FETCh[:SCALar]:POWer:APParent?**

## **MEASure[:SCALar]:POWer:APParent?**

This command is used to read the apparent power value.

Note: this command parameter is optional. If there is no parameter, it will return the value of A, B, C three-phase by default.

Syntax:

FETCh[:SCALar]:POWer:APParent? [A|B|C|CH1|CH2|CH3]

Arguments:

[A|B|C|CH1|CH2|CH3]

Returns:

<NRf>...

Example:

```
FETC:POW:APP?
```

## **FETCh[:SCALar]:POWer:REACtive?**

## **MEASure[:SCALar]:POWer:REACtive?**

This command is used to read the reactive power value.

Note: this command parameter is optional. If there is no parameter, it will return the value of A, B, C three-phase by default.

Syntax:

```
FETCh[:SCALar]:POWer:REACtive? [A|B|C|CH1|CH2|CH3]
```

Arguments:

```
[A|B|C|CH1|CH2|CH3]
```

Returns:

```
<NRf>...
```

Example:

```
FETC:POW:REAC?
```

## **FETCh[:SCALar]:POWer:PFACtor?**

## **MEASure[:SCALar]:POWer:PFACtor?**

This command is used to read the power factor value.

Note: this command parameter is optional. If there is no parameter, it will return the value of A, B, C three-phase by default.

Syntax:

```
FETCh[:SCALar]:POWer:PFACtor? [A|B|C|CH1|CH2|CH3]
```

Arguments:

```
[A|B|C|CH1|CH2|CH3]
```

Returns:

```
<NRf>...
```

Example:

```
FETC:POW:PFAC?
```

## **FETCh[:SCALar]:VOLTage[:AC]?**

### **MEASure[:SCALar]:VOLTage[:AC]?**

This command is used to read the effective value of voltage.

Note: this command parameter is optional. If there is no parameter, it will return the value of A, B, C three-phase by default.

Syntax:

```
FETCh[:SCALar]:VOLTage? [A|B|C|CH1|CH2|CH3]
```

Arguments:

```
[A|B|C|CH1|CH2|CH3]
```

Returns:

```
<NRf>...
```

Example:

```
FETC:VOLT?
```

## **FETCh[:SCALar]:VOLTage:DC?**

### **MEASure[:SCALar]:VOLTage:DC?**

This command is used to read the DC component of voltage.

Note: this command parameter is optional. If there is no parameter, it will return the value of A, B, C three-phase by default.

Syntax:

```
FETCh[:SCALar]:VOLTage:DC? [A|B|C|CH1|CH2|CH3]
```

Arguments:

```
[A|B|C|CH1|CH2|CH3]
```

Returns:

```
<NRf> ...
```

Example:

```
FETC:VOLT:DC?
```

## **FETCh[:SCALar]:VOLTage:AMPLitude:MAXimum?**

### **MEASure[:SCALar]:VOLTage:AMPLitude:MAXimum?**

This command is used to read the peak value of voltage.

Note: this command parameter is optional. If there is no parameter, it will return

the value of A, B, C three-phase by default.

Syntax:

```
FETCh[:SCALar]:VOLTage:AMPLitude:MAXimum? [A|B|C|CH1|CH2|CH3]
```

Arguments:

```
[A|B|C|CH1|CH2|CH3]
```

Returns:

```
<NRf>...
```

Example:

```
FETC:VOLT:AMP:MAX?
```

## **FETCh[:SCALar]:VOLTage:AMPLitude:MAXimum:POSitive?**

## **MEASure[:SCALar]:VOLTage:AMPLitude:MAXimum:POSitive?**

This command is used to read the positive peak value of voltage.

Note: this command parameter is optional. If there is no parameter, it will return the value of A, B, C three-phase by default.

Syntax:

```
FETCh[:SCALar]:VOLTage:AMPLitude:MAXimum:POSitive?  
[A|B|C|CH1|CH2|CH3]
```

Arguments:

```
[A|B|C|CH1|CH2|CH3]
```

Returns:

```
<NRf> ...
```

Example:

```
FETC:VOLT:AMP:MAX:POS?
```

## **FETCh[:SCALar]:VOLTage:AMPLitude:MAXimum:NEGative?**

## **MEASure[:SCALar]:VOLTage:AMPLitude:MAXimum:NEGative?**

This command is used to read the negative peak value of voltage.

Note: this command parameter is optional. If there is no parameter, it will return the value of A, B, C three-phase by default.

Syntax:

```
FETCh[:SCALar]:VOLTage:AMPLitude:MAXimum:NEGative?  
[A|B|C|CH1|CH2|CH3]
```

Arguments:

[A|B|C|CH1|CH2|CH3]

Returns:

<NRf> ...

Example:

FETC:VOLT:AMP:MAX:NEG?

## FETCh[:SCALAr]?

## MEASure[:SCALAr]?

This command is used to get all METER data.

Note: this command parameter is optional. If there is no parameter, it will return the value of A, B, C three-phase by default.

Syntax:

FETCh[:SCALAr]? [A|B|C|CH1|CH2|CH3]

Arguments:

[A|B|C|CH1|CH2|CH3]

Returns:

<NRf> ...

Example:

FETC?

- When the optional parameter is set to [A|B|C|CH1|CH2|CH3], the returns are <float>, ..., <float> (17+2=19 floating meter values), and the meter values are in order:  
 (Urms, Irms, P, Upp, Upn, Ipp, Ipn, Freq, CF, PF, S, Q, Udc, Idc, Uthd, Ipeak, Ithd, Uac, Iac)
- When the optional parameter is set to default, the returns are <float>, ..., <float> (17\*3+6+6=63 floating meter values), and the meter values are in order:  
 (A\_Urms, A\_Irms, A\_P, A\_Upp, A\_Upn, A\_Ipp, A\_Ipn, A\_Freq, A\_CF, A\_PF, A\_S, A\_Q, A\_Udc, A\_Idc, A\_Uthd, A\_Ipeak, A\_Ithd, B\_Urms, B\_Irms, B\_P, B\_Upp, B\_Upn, B\_Ipp, B\_Ipn, B\_Freq, B\_CF, B\_PF, B\_S, B\_Q, B\_Udc, B\_Idc, B\_Uthd, B\_Ipeak, B\_Ithd, C\_Urms, C\_Irms, C\_P, C\_Upp, C\_Upn, C\_Ipp, C\_Ipn, C\_Freq, C\_CF, C\_PF, C\_S, C\_Q, C\_Udc, C\_Idc, C\_Uthd, C\_Ipeak, C\_Ithd, total\_P, total\_S, total\_Q, Uca, Uba, Ucb, Uac\_a, Uac\_b, Uac\_c, lac\_a, lac\_b, lac\_c)

MEASure?

- When the optional parameter is set to [A|B|C|CH1|CH2|CH3], the returns are <float>,...,<float> (17 floating meter values), and the meter values are in order:  
 (Urms,Irms,P,Upp,Upn,Ipp,Ipn,Freq,CF,PF,S,Q,Udc,Idc,Uthd,Ipeak,Ithd)
- When the optional parameter is set to default, the returns are<float>,...,<float> (17\*3+6=57 floating meter values), and the meter values are in order:  
 (A\_Urms,A\_Irms,A\_P,A\_Upp,A\_Upn,A\_Ipp,A\_Ipn,A\_Freq,A\_CF,A\_PF,A\_S,A\_Q,A\_Udc,A\_Idc,A\_Uthd,A\_Ipeak,A\_Ithd,  
 B\_Urms,B\_Irms,B\_P,B\_Upp,B\_Upn,B\_Ipp,B\_Ipn,B\_Freq,B\_CF,B\_PF,B\_S,B\_Q,B\_Udc,B\_Idc,B\_Uthd,B\_Ipeak,B\_Ithd,  
 C\_Urms,C\_Irms,C\_P,C\_Upp,C\_Upn,C\_Ipp,C\_Ipn,C\_Freq,C\_CF,C\_PF,C\_S,C\_Q,C\_Udc,C\_Idc,C\_Uthd,C\_Ipeak,C\_Ithd,  
 total\_P,total\_S,total\_Q,Uba,Uca,Ucb)

## FETCh[:SCALar]:POWer[:REAL]:TOTAl?

## MEASure[:SCALar]:POWer[:REAL]:TOTAl?

This command is used to read the total power value.

Syntax:

FETCh[:SCALar]:POWer [:REAL]?

Arguments:

None

Returns:

<NRf>

Example:

FETC:POW?

## FETCh[:SCALar]:POWer:APParent:TOTAl?

## MEASure[:SCALar]:POWer:APParent:TOTAl?

This command is used to read the total apparent power value.

Syntax:

FETCh[:SCALar]:POWer:APParent?

Arguments:

None

Returns:

<NRf>

Example:

```
FETC:POW:APP:TOT?
```

## **FETCh[:SCALar]:POWer:REACtive:TOTal?**

## **MEASure[:SCALar]:POWer:REACtive:TOTal?**

This command is used to read the total reactive power value.

Syntax:

```
FETCh[:SCALar]:POWer:REACtive?
```

Arguments:

None

Returns:

<NRf>

Example:

```
FETC:POW:REAC:TOT?
```

## **FETCh[:SCALar]:LTLVoltage[:AC]?**

## **MEASure[:SCALar]:LTLVoltage[:AC]?**

This command is used to read the line voltage value between B and A, or between C and A, or between C and B.

Syntax:

```
FETCh[:SCALar]:LTLVoltage? <BA|CA|CB>
```

Arguments:

<BA|CA|CB>

Returns:

<NRf>

Example:

```
FETC:LTLV? CB
```

**FETCh[:SCALar]:VOLTage:HARMonic[:AMPLitude]?  
<[A|B|C|CH1|CH2|CH3]>,<NR1>**

**MEASure[:SCALar]:VOLTage:HARMonic[:AMPLitude]?  
<[A|B|C|CH1|CH2|CH3]>,<NR1>**

This command is used to measure the amplitude of voltage harmonics.

Syntax:

FETCh[:SCALar]:VOLTage:HARMonic[:AMPLitude]?  
<[A|B|C|CH1|CH2|CH3]>,<NR1>

Arguments:

<[A|B|C|CH1|CH2|CH3]>,<NR1>  
NR1: 0-50

Returns:

<NRf>

Example:

FETC:VOLT:HARM? A,4

**FETCh[:SCALar]:CURRent:HARMonic[:AMPLitude]?  
<[A|B|C|CH1|CH2|CH3]>,<NR1>**

**MEASure[:SCALar]:CURRent:HARMonic[:AMPLitude]?  
<[A|B|C|CH1|CH2|CH3]>,<NR1>**

This command is used to measure the amplitude of current harmonics.

Syntax:

FETCh[:SCALar]:CURRent:HARMonic[:AMPLitude]?  
<[A|B|C|CH1|CH2|CH3]>,<NR1>

Arguments:

<[A|B|C|CH1|CH2|CH3]>,<NR1>  
NR1: 0-50

Returns:

<NRf>

Example:

FETC:CURR:HARM? A,5

**FETCh[:SCALar]:VOLTage:HARMonic:DISTort?**  
**<[A|B|C|CH1|CH2|CH3]>,<NR1>**

**MEASure[:SCALar]:VOLTage:HARMonic:DISTort?**  
**<[A|B|C|CH1|CH2|CH3]>,<NR1>**

This command is used to measure voltage harmonic components.

Syntax:

FETCh[:SCALar]:VOLTage:HARMonic:DISTort? <[A|B|C|CH1|CH2|CH3]>,<NR1>

Arguments:

<[A|B|C|CH1|CH2|CH3]>,<NR1>

NR1: 0-50

Returns:

<NRf>

Example:

FETC:VOLT:HARM:DIST? A,8

**FETCh[:SCALar]:CURRent:HARMonic:DISTort?**  
**<[A|B|C|CH1|CH2|CH3]>,<NR1>**

**MEASure[:SCALar]:CURRent:HARMonic:DISTort?**  
**<[A|B|C|CH1|CH2|CH3]>,<NR1>**

This command is used to measure current harmonic components.

Syntax:

FETCh[:SCALar]:CURRent:HARMonic:DISTort?  
<[A|B|C|CH1|CH2|CH3]>,<NR1>

Arguments:

<[A|B|C|CH1|CH2|CH3]>,<NR1>

NR1: 0-50

Returns:

<NRf>

Example:

FETC:CURR:HARM:DIST? 3,10

**FETCh[:SCALar]:VOLTage:HARMonic:PHASe?  
<[A|B|C|CH1|CH2|CH3]>,<NR1>**

**MEASure[:SCALar]:VOLTage:HARMonic:PHASe?  
<[A|B|C|CH1|CH2|CH3]>,<NR1>**

This command is used to measure the phase of voltage harmonics.

Syntax:

FETCh[:SCALar]:VOLTage:HARMonic:PHASe? <[A|B|C|CH1|CH2|CH3]>,<NR1>

Arguments:

<[A|B|C|CH1|CH2|CH3]>,<NR1>

NR1: 0-50

Returns:

<NRf>

Example:

FETC:VOLT:HARM:PHAS? 2,5

**FETCh[:SCALar]:CURRent:HARMonic:PHASe?  
<[A|B|C|CH1|CH2|CH3]>,<NR1>**

**MEASure[:SCALar]:CURRent:HARMonic:PHASe?  
<[A|B|C|CH1|CH2|CH3]>,<NR1>**

This command is used to measure the phase of current harmonics.

Syntax:

FETCh[:SCALar]:CURRent:HARMonic:PHASe?  
<[A|B|C|CH1|CH2|CH3]>,<NR1>

Arguments:

<[A|B|C|CH1|CH2|CH3]>,<NR1>

NR1: 0-50

Returns:

<NRf>

Example:

FETC:CURR:HARM:PHAS? 2,10

## **FETCh[:SCALar]:VOLTage:HARMonic:THD? <[A|B|C|CH1|CH2|CH3]>**

## **MEASure[:SCALar]:VOLTage:HARMonic:THD? <[A|B|C|CH1|CH2|CH3]>**

This command is used to measure the total harmonic distortion of the voltage.

### Syntax:

FETCh[:SCALar]:VOLTage:HARMonic:THD? <[A|B|C|CH1|CH2|CH3]>

### Arguments:

<[A|B|C|CH1|CH2|CH3]>

### Returns:

<NRf>

### Example:

FETC: VOLT:HARM:THD? C

## **FETCh[:SCALar]:CURRent:HARMonic:THD? <[A|B|C|CH1|CH2|CH3]>**

## **MEASure[:SCALar]:CURRent:HARMonic:THD? <[A|B|C|CH1|CH2|CH3]>**

This command is used to measure the total harmonic distortion of the current.

### Syntax:

FETCh[:SCALar]:CURRent:HARMonic:THD? <[A|B|C|CH1|CH2|CH3]>

### Arguments:

<[A|B|C|CH1|CH2|CH3]>

### Returns:

<NRf>

### Example:

FETC: CURR:HARM:THD? A

**FETCh[:SCALar]:ARRay:VOLTage:HARMonic[:AMPLitude]? <[A|B|C|CH1|CH2|CH3]>,<NR1>**

**MEASure[:SCALar]:ARRay:VOLTage:HARMonic[:AMPLitude]? <[A|B|C|CH1|CH2|CH3]>,<NR1>**

This command is used to measure each harmonic amplitude of the voltage.

Meaning: the value range of NR1 is 0-50, the 0th order represents the DC component, the 1st order represents the fundamental wave, and the 2nd to 50th order the harmonic components. In this command, if NR1 is assigned a value of 10, the result will list the harmonic amplitude of the voltage from 0 to 10th.

Syntax:

```
FETCh[:SCALar]:ARRay:VOLTage:HARMonic[:AMPLitude]?  
<[A|B|C|CH1|CH2|CH3]>,<NR1>
```

Arguments:

```
<[A|B|C|CH1|CH2|CH3]>,<NR1>
```

Returns:

```
<NRf>
```

Example:

```
FETC:ARR:VOLT:HARM? B,11
```

**FETCh[:SCALar]:ARRay:CURREnt:HARMonic[:AMPLitude]? <[A|B|C|CH1|CH2|CH3]>,<NR1>**

**MEASure[:SCALar]:ARRay:CURREnt:HARMonic[:AMPLitude]? <[A|B|C|CH1|CH2|CH3]>,<NR1>**

This command is used to measure each harmonic amplitude of the current.

Syntax:

```
FETCh[:SCALar]:ARRay:CURREnt:HARMonic[:AMPLitude]?  
<[A|B|C|CH1|CH2|CH3]>,<NR1>
```

Arguments:

```
<[A|B|C|CH1|CH2|CH3]>,<NR1>
```

```
NR1: 0-50
```

Returns:

```
<NRf>
```

Example:

```
FETC:ARR:CURR:HARM? A,6
```

**FETCh[:SCALar]:ARRay:VOLTage:HARMonic:PHASe?  
<[A|B|C|CH1|CH2|CH3]>,<NR1>**

**MEASure[:SCALar]:ARRay:VOLTage:HARMonic:PHASe?  
<[A|B|C|CH1|CH2|CH3]>,<NR1>**

This command is used to measure each harmonic phase of the voltage.

Syntax:

FETCh[:SCALar]:ARRay:VOLTage:HARMonic:PHASe?  
<[A|B|C|CH1|CH2|CH3]>,<NR1>

Arguments:

<[A|B|C|CH1|CH2|CH3]>,<NR1>  
NR1: 0-50

Returns:

<NRf>

Example:

FETC:ARR:VOLT:HARM:PHAS? 3,6

**FETCh[:SCALar]:ARRay:CURREnt:HARMonic:PHASe?  
<[A|B|C|CH1|CH2|CH3]>,<NR1>**

**MEASure[:SCALar]:ARRay:CURREnt:HARMonic:PHASe?  
<[A|B|C|CH1|CH2|CH3]>,<NR1>**

This command is used to measure each harmonic phase of the current.

Syntax:

FETCh[:SCALar]:ARRay:CURREnt:HARMonic:PHASe?  
<[A|B|C|CH1|CH2|CH3]>,<NR1>

Arguments:

<[A|B|C|CH1|CH2|CH3]>,<NR1>  
NR1: 0-50

Returns:

<NRf>

Example:

FETC:ARR:CURR:HARM:PHAS? 4

**FETCh[:SCALar]:ARRay:VOLTage:HARMonic:DISTort?  
<[A|B|C|CH1|CH2|CH3]>,<NR1>**

**MEASure[:SCALar]:ARRay:VOLTage:HARMonic:DISTort?  
t? <[A|B|C|CH1|CH2|CH3]>,<NR1>**

This command is used to measure each harmonic distortion of the voltage.

Syntax:

FETCh[:SCALar]:ARRay:VOLTage:HARMonic:DISTort?  
<[A|B|C|CH1|CH2|CH3]>,<NR1>

Arguments:

<[A|B|C|CH1|CH2|CH3]>,<NR1>  
NR1: 0-50

Returns:

<NRf>

Example:

FETC:ARR:VOLT:HARM:DIST? 6

**FETCh[:SCALar]:ARRay:CURREnt:HARMonic:DISTort?  
<[A|B|C|CH1|CH2|CH3]>,<NR1>**

**MEASure[:SCALar]:ARRay:CURREnt:HARMonic:DISTort?  
t? <[A|B|C|CH1|CH2|CH3]>,<NR1>**

This command is used to measure each harmonic distortion of the current.

Syntax:

FETCh[:SCALar]:ARRay:CURREnt:HARMonic:DISTort?  
<[A|B|C|CH1|CH2|CH3]>,<NR1>

Arguments:

<[A|B|C|CH1|CH2|CH3]>,<NR1>  
NR1: 0-50

Returns:

<NRf>

Example:

FETC:ARR:CURR:HARM:DIST? 6

## **FETCh[:SCALar]:WHOur[:ACTive][:SUM]?**

This command is used to read the sum of the most recent positive and negative watt-hours.

Syntax:

FETCh[:SCALar]:WHOur[:ACTive][:SUM]?

Arguments:

<NRf>

Example:

FETCh:WHOur?

## **FETCh[:SCALar]:WHOur[:ACTive]:POSitive?**

This command is used to read the most recently consumed positive watt-hour.

Syntax:

FETCh[:SCALar]:WHOur[:ACTive]:POSitive?

Arguments:

<NRf>

Example:

FETCh:WHOur:POSitive?

## **FETCh[:SCALar]:WHOur[:ACTive]:NEGative?**

This command is used to read the negative watt-hour of the nearest feedback power supply.

Syntax:

FETCh[:SCALar]:WHOur[:ACTive]:NEGative?

Arguments:

<NRf>

Example:

FETCh:WHOur:NEGative?

## **FETCh[:SCALar]:AHOuR[:ACTive][:SUM]?**

This command is used to read the sum of the most recent positive and negative amp hours.

Syntax:

FETCh[:SCALar]:AHOuR[:ACTive][:SUM]?

Arguments:

<NRf>

Example:

FETCh:AHOur?

## **FETCh[:SCALar]:AHOur[:ACTive]:POSitive?**

This command is used to read the most recently consumed positive amp-hour.

Syntax:

FETCh[:SCALar]:AHOur[:ACTive]:POSitive?

Arguments:

<NRf>

Example:

FETCh:AHOur:POSitive?

## **FETCh[:SCALar]:AHOur[:ACTive]:NEGative?**

This command is used to read the negative amp-hour of the nearest feedback power supply.

Syntax:

FETCh[:SCALar]:AHOur[:ACTive]:NEGative?

Arguments:

<NRf>

Example:

FETCh:AHOur:NEGative?

## **FETCh[:SCALar]:ENERgy:TIME?**

This command is used to read the most recent integration time.

Syntax:

FETCh[:SCALar]:ENERgy:TIME?

Arguments:

<NRf>

Example:

FETCh:ENERgy:TIME?

## **VETCor:OEDer <NR1>**

This command is used to set and query the order of the vector diagram.

**Syntax:**

VETCor:OEDer

**Arguments:**

&lt;NR1&gt;

NR1: 0-50

**Returns:**

&lt;NRf&gt;

**Query syntax**

VETC:OED?

**Example:**

VETC:OED 19

**MEASure[:SCALar]:VECTor:DATA?****FETCh[:SCALar]:VECTor:DATA?**

This command is used to query the vector data of present order.

**Syntax:**

MEASure[:SCALar]:VECTor:DATA?

FETCh[:SCALar]:VECTor:DATA?

**Arguments:**

Null

**Returns:**

&lt;NRf&gt;,&lt;NRf&gt;,&lt;NRf&gt;,&lt;NRf&gt;,&lt;NRf&gt;,&lt;NRf&gt;

**Example:**

MEAS:VECTor:DATA?

**MEASure[:SCALar]:VECTor:TYPE <CPD>****FETCh[:SCALar]:VECTor:TYPE <CPD>**

This command is used to set the vector type.

**Syntax:**

MEASure[:SCALar]:VECTor:TYPE &lt;CPD&gt;

FETCh[:SCALar]:VECTor:TYPE &lt;CPD&gt;

Arguments:

<U|I>

Returns:

U|I

Query syntax:

VETCor:TYPE?

Example:

VETC:TYPE I

## VETCor:DATA?

This command is used to query the vector data corresponding to the present order.

Syntax:

VETCor:DATA?

Arguments:

None

Returns:

<NRf>,<NRf>,<NRf>,<NRf>,<NRf>,<NRf>

Example:

VETCor:DATA?

## VETCor:TYPE <CPD>

This command is used to set and query the vector type.

Syntax:

VETCor:TYPE <CPD>

Arguments:

<U||ALL>

Returns:

U||ALL

Query syntax

VETCor:TYPE??

Example:

VETC:TYPE I

---

## Chapter16 ARB Subsystem (Source)

---

### [ARB:]LIST:STATe?

This command is used to query the running status of the list: IDLE: stop, WTG: waiting for trigger, ACTive: running.

#### Syntax

[ARB:]LIST:STATe?

#### Example

LIST:STAT?

### [ARB:]LIST:REPeat <NR1>

This command is used to set and query the number of cycles that the list runs.

#### Syntax

[ARB:]LIST:REPeat <NR1>

#### Argument:

<NR1>|MINimum|MAXimum|DEFault

#### \*RST

0

#### Query syntax

[ARB:]LIST:REPeat?

#### Returns

<NR1>

#### Example

LIST:REP 10

### [ARB:]LIST:TERMinate <CPD>

This command is used to set and query the way to end the list operation. There are three ways to end:

NORMal: after the list runs, it will automatically return to normal.

LAST: keep the output of the last step after the list runs.

OFF: turn off the output after the list operation is over and still in the list mode.

#### Syntax

[ARB:]LIST:TERMinate <CPD>

## Argument

<CPD>  
 NORMal|LAST|OFF

## Query syntax

[ARB:]LIST:TERMinate

## Returns

NORMal|LAST|OFF

## \*RST

OFF

## Example

LIST:TERM LAST

## [ARB:]LIST:RUNTime:STATe?

This command is used to query the runtime information of List, in which loop the list is presently running, and at which step it is presently running.

Return value: <NR1>,<NR1> The first is the number of cycles presently running, and the second is the position of the present running step.

## Syntax

[ARB:]LIST:RUNTime:STATe?

## Returns

<NR1>,<NR1>

## Example

LIST:RUNTime:STATe?

## [ARB:]LIST:RCL <string>

This command is used to call back the saved list file and query the file name presently called.

## Syntax

[ARB:]LIST:RCL <string>

## Query syntax

[ARB:]LIST:RCL?

## Example

LIST:RCL test.csv

## [ARB:]LIST:STEP:COUNT <NR1>

This command is used to set and query the total number of steps in the list.

## Syntax

[ARB:]LIST:STEP:COUNT <NR1>

## Argument

<NR1>|MINimum|MAXimum|DEFault

## Query syntax

[ARB:]LIST:STEP:COUNT?

## Returns

<NR1>

## \*RST

10

## Example

LIST:STEP:COUN 10

## [ARB:]LIST:CLEAr

This command is used to clear the list configuration.

## Syntax

[ARB:]LIST:CLEAr

## Example

LIST:CLE

## [ARB:]LIST:STEP <NR1>,<string>

This command is used to configure and query the list step parameters.

<NR1>: step index

<string>: the parameters are separated by commas, and the specific order is as follows:

- Three phase

A\_Vac: AC voltage of A Phase

B\_Vac: AC voltage of B Phase

C\_Vac: AC voltage of C Phase

A\_Vac\_slew: AC voltage slope of phase A

B\_Vac\_slew: AC voltage slope of phase B

C\_Vac\_slew: AC voltage slope of phase C

A\_Vdc: DC voltage of A Phase

B\_Vdc : DC voltage of B Phase

C\_Vdc : DC voltage of C Phase

A\_Vdc\_slew: DC voltage slope of phase A

B\_Vdc\_slew: DC voltage slope of phase B

C\_Vdc\_slew: DC voltage slope of phase C

Phase mode: CONTInues|PHASe

A\_start: starting angle of phase A

ba\_diff: phase difference of BA

ba\_diff\_slew: Phase differenct slew rate of BA

ca\_diff : phase difference of CA

ca\_diff\_slew : Phase differenct slew rate of CA

Frequency: Frequency

Frequency\_slew: frequency slope

A\_wave: waveform type of phase A

B\_wave: waveform type of phase B

C\_wave: waveform type of phase C

Step Jump para1: step jump mode, TIME|TRIGger|PHASe

Step Jump para2: if the para1 is set to TIME, this parameter is time value. If the para1 is set to TRIGger, this parameter is IMMe or PHASe. And if para1 is set to PHASe, this parameter is angle value.

Step Jump para3: if para1 is set to TRIGger and para2 is set to PHASe, this parameter is angle value.

Trig\_out: output a trigger signal.

- Single mode/ Reverse mode:

Vac : AC voltage

Vac\_slew : AC voltage slope

Vdc : DC voltage

Vdc\_slew : DC voltage slope

Phase mode: CONTInues|PHASe

Start: start angle

Frequency : frequency

Frequency\_slew : frequency slope

wave : waveform type

Step Jump para1: step jump mode, TIME|TRIGger|PHASe

Step Jump para2: if the para1 is set to TIME, this parameter is time value. If the para1 is set to TRIGger, this parameter is IMMe or PHASe. And if para1 is set to PHASe, this parameter is angle value.

Step Jump para3: if para1 is set to TRIGger and para2 is set to PHASe, this parameter is angle value.

Trig\_out: output a trigger signal.

## Syntax

```
[ARB:]LIST:STEP <NR1>,<string>
```

## Query syntax

```
[ARB:]LIST:STEP? <NR1>
```

## Example

```
list:step
-1,"10,10,10,100,100,100,0.5,0.5,0.5,20,20,20,PHASe,356.9,30,100,40,120,100,
101,Sine,Sine,Sine,TRIG,PHASE,55,OFF"
```

```
//single phase mode
```

```
list:step
-1,"10,10,10,100,100,100,0.5,0.5,0.5,20,20,20,PHASe,356.9,30,100,40,120,100,
101,Sine,Sine,Sine,TRIG,PHASE,55,OFF"
```

```
//three phase mode
```

## [ARB:]LIST:STEP:ITEM <NR1>,<NR2>,<string>

This command is used to configure and query the phase parameters of a certain step in the list.

<NR1>: Step index , [1,100]

<NR2>:

Note: The following are all the parameter IDs of the three-phase mode, those marked with "single-phase" indicate that they can be used to set and query the corresponding parameter values in the single-phase mode.

A phase AC voltage ID:	0 (single-phase)
B phase AC voltage ID:	1
C phase AC voltage ID:	2
A phase AC voltage slope ID:	3 (single-phase)
B phase AC voltage slope ID:	4
C phase AC voltage slope ID:	5
A phase DC voltage ID:	6 (single-phase)
B phase DC voltage ID:	7
C phase DC voltage ID:	8
A phase DC voltage slope ID:	9 (single-phase)
B phase DC voltage slope ID:	10
C phase DC voltage slope ID:	11
Phase mode ID:	12 (single-phase)(PHASe CONTInues)
A Phase start angle ID:	13 (single-phase)
B Phase start angle ID:	14(Reserved)
C Phase start angle ID:	15(Reserved)
A Phase frequency ID:	16 (single-phase)
B Phase frequency ID:	17(Reserved)

C Phase frequency ID: 18(Reserved)  
 A Phase frequency slope ID: 19 (single-phase)  
 B Phase frequency slope ID: 20(Reserved)  
 C Phase frequency slope ID: 21(Reserved)  
 A Phase waveform type ID: 22 (single-phase)  
 B Phase waveform type ID: 23  
 C Phase waveform type ID: 24  
 Step jump 1 ID: 25 (single-phase) (TIME|TRIGger|PHASe)  
 Step jump 2 ID: 26 (single-phase) (When Step jump 1 ID is TIME, this parameter is the time value; when Step jump 1 ID is TRIGger, this parameter can be IMMEDIATE/PHASe; when Step jump 1 ID is PHASe, this parameter is the angle value)  
 Trigger Pulse ID: 27 (single-phase) (OFF|ON)  
 BA angle ID 28  
 BA angle slope ID 29  
 CA angle ID 30  
 CA angle slope ID 31  
 Step jump 3 ID 32 (single-phase) (This parameter is meaningful only when jump Step jump 1 ID is TRIGger and Step jump 2 ID is PHASe, which is the angle value)  
 <string>: This parameter is the corresponding parameter value for the ID specified by NR2.

## Syntax

LIST:STEP:ITEM <NR1>,<NR2>,<string>

## Query syntax

LIST:STEP:ITEM? <NR1>,<item>

## Example

```

LIST:STEP:ITEM 1,0,"100" //Set A-phase AC voltage to 100V in step 1
LIST:STEP:ITEM 1,22,"Sine" //Set the A-phase waveform type to Sine in step1
LIST:STEP:ITEM? 1,0 //Query A-phase AC voltage value
  
```

## **[ARB:]LIST:STEP:ITEM? <NR1>,<item>**

This command is used to query the phase parameters of a certain step in the list.

## Syntax

[ARB:]LIST:STEP:ITEM? <NR1>,<item>

## Argument:

<NR1>,<item>

Returns:

<NRf+>

Example

LIST:STEP:ITEM? 1,6

## **[ARB:]LIST:NAME?**

This command is used to query the path name of the presently opened list file.

Syntax

[ARB:]LIST:NAME?

Example

LIST:NAME?

## **[ARB:]LIST:SAVe <filename>**

This command is used to save the file to the /mnt/emm\_user/user\_data/sys/list/ directory. If the file name already exists, the present file will be overwritten, if it does not exist, it will be saved as a new file.

Syntax

[ARB:]LIST:SAVe <filename>

Example

LIST:SAVe "123"

## **[ARB:]LIST:CONFigure**

This command is used to make the presently configured list parameters take effect.

Syntax

[ARB:]LIST:CONFigure

Example

LIST:CONF

## **[ARB:]LIST:CREate**

This command is used to create a list.

Syntax

[ARB:]LIST:CREate

Example

LIST:CRE

## **[ARB:]LIST:FILE:NUMBER?**

This command is used to query the number of list files under the present device type.

### Syntax

```
[ARB:]LIST:FILE:NUMBER?
```

### Example

```
LIST:FILE:NUMB?
```

## **[ARB:]LIST:FILE:NAME? <index>**

This command is used to query the name of a list file according to the index.

### Syntax

```
[ARB:]LIST:FILE:NAME? <index>
```

### Argument:

```
<NR1>
```

### Example

```
LIST:FILE:NAME? 1
```

## **[ARB:]LIST:FILE:DELeTe <filename>**

This command is used to delete the list file.

### Syntax

```
[ARB:]LIST:FILE:DELeTe <filename>
```

### Argument

```
<CPD>
```

### Example

```
LIST:FILE:DEL "123"
```

## **[ARB:]LIST:STEP:DELeTe <NR1>**

This command is used to delete the list step.

### Syntax

```
[ARB:]LIST:STEP:DELeTe <NR1>
```

### Argument

```
<NR1>
```

### Example

```
LIST:STEP:DELeTe 1 //delete the step1
```

## [ARB:]LIST:STEP:EDIT <NR1>,<string>

This command is used to edit the list step parameter.

Note: This command only modifies the parameters of the currently existing steps, and does not add new steps.

### Syntax

```
[ARB:]LIST:STEP:EDIT <NR1>,<string>
```

### Argument

<NR1>: step number

<string>: step parameters

### Example

```
list:step:edit  
1,"10,10,10,100,100,100,0.5,0.5,0.5,20,20,20,PHASe,356.9,30,100,40,120,100,1  
01,Sine,Sine,Sine,TRIG,PHASE,55,OFF" //edit the step parameters for three  
phase  
list:step:edit 1,"9.2,100,21,20,PHASe,359.9,100,100,Sine,TRIG,phase,123,ON"  
//edit the step parameters for single phase
```

## LIST:STEP:JUMP <NR1>

The command is used to set the step number of the loop skip, for example, when set to 2, the subsequent loop skips the previous two steps and starts from step 3.

NR1: the minimum value is 0, i.e. all steps without skipped steps are looped; the maximum value is less than the total number of steps.

### Syntax

```
LIST:STEP:JUMP <NR1>
```

### Argument

<NR1>: step number

### Query Syntax

```
LIST:STEP:JUMP? [MAXimum|MINimum]
```

### Example

```
LIST:STEP:JUMP 2
```

## Chapter17 SWEEp Subsystem (Source)

### **SWEEp:VOLTage:STARt <NRf+>[,<NRf+>,<NRf+>]**

This command is used to set and query the start voltage of Sweep.

<NRf+>: initial voltage setting value, or initial voltage MINimum or MAXimum or DEFault setting

Note:

In single-phase (including AC, ACDC, DC, DCAC), there is only one parameter; in three-phase, three parameters must be taken.

#### Syntax

SWEEp:VOLTage:STARt <NRf+>[,<NRf+>,<NRf+>]

#### Argument

<NRf+>[,<NRf+>,<NRf+>]

#### \*RST

0

#### Query syntax

SWEEp:VOLTage:STARt? [A|B|C][MAXimum|MINimum|DEFault]

#### Returns

<NR2>

#### Example

SWEEp:VOLTage:STARt 100 //Set the starting voltage of sweep to 100V.

SWEEp:VOLTage:STARt? //Query the setting value of sweep starting voltage.

SWEEp:VOLTage:STARt? MAX //Query the maximum value of sweep initial Voltage.

### **SWEEp:VOLTage:STOP <NRf+>[,<NRf+>,<NRf+>]**

This command is used to set and query the stop voltage of sweep.

<NRf+>: stop voltage setting value, or stop voltage MINimum or MAXimum or DEFault setting.

Note:

In single-phase (including AC, ACDC, DC, DCAC), there is only one parameter; in three-phase, three parameters must be taken.

#### Syntax

SWEEp:VOLTage:STOP <NRf+>[,<NRf+>,<NRf+>]

## Argument

<NRf+>[,<NRf+>,<NRf+>]

## Query syntax

SWEep:VOLTage:STOP? [A|B|C][MAXimum|MINimum|DEFault]

## Returns

<NR2>

## Example

```
SWEep:VOLTage:STOP 90           //Set the stop voltage of sweep to 90V.
SWEep:VOLTage:STOP?             //Query the presently set stop voltage.
SWEep:VOLTage:STOP? MAX        //Query the maximum value of stop voltage.
```

## **SWEep:VOLTage:STEP <NRf+>[,<NRf+>,<NRf+>]**

This command is used to set and query the step voltage of sweep.

<NRf+>: step voltage setting value, or step MINimum or MAXimum or DEFault setting.

Note:

In single-phase (including AC, ACDC, DC, DCAC), there is only one parameter; in three-phase, three parameters must be taken.

## Syntax

SWEep:VOLTage:STEP <NRf+>[,<NRf+>,<NRf+>]

## Argument

<NRf+>[,<NRf+>,<NRf+>]

## \*RST

0

## Query syntax

SWEep:VOLTage:STEP? [A|B|C][MAXimum|MINimum|DEFault]

## Returns

<NR2>

## Example

```
SWEep:VOLTage:STEP 1 // Set the step voltage of sweep to 1V.
SWEep:VOLTage:STEP? // Query the presently set step voltage.
SWEep:VOLTage:STEP? MAX // Query the maximum value of step voltage.
```

## **SWEep:FREQ:START <NRf+>[,<NRf+>,<NRf+>]**

This command is used to set and query the start frequency of sweep.

<NRf+>: the set value of the start frequency, or the MINimum or MAXimum or DEFault setting of start frequency.

Note:

In single-phase (including AC, ACDC, DC, DCAC), there is only one parameter; in three-phase, three parameters must be taken.

### Syntax

SWEep:FREQ:START <NRf+>[,<NRf+>,<NRf+>]

### Argument

<NRf+>[,<NRf+>,<NRf+>]

### \*RST

0

### Query syntax

SWEep:FREQ:START? [A|B|C][MAXimum|MINimum|DEFault]

### Returns

<NR2>

### Example

```
SWEep:FREQ:START 1 //Set the start frequency of sweep to 1Hz.
SWEep:FREQ:START? //Query the presently set start frequency.
SWEep:FREQ:START? MAX //Query the maximum value of the start frequency.
```

## **SWEep:FREQ:STOP <NRf+>[,<NRf+>,<NRf+>]**

This command is used to set and query the stop frequency of sweep.

<NRf+>: stop frequency setting value, or stop frequency MINimum or MAXimum or DEFault setting.

Note:

In single-phase (including AC, ACDC, DC, DCAC), there is only one parameter; in three-phase, three parameters must be taken.

### Syntax

SWEep:FREQ:STOP <NRf+>[,<NRf+>,<NRf+>]

### Argument

<NRf+>[,<NRf+>,<NRf+>]

### \*RST

0

### Query syntax

SWEep:FREQ:STOP? [A|B|C][MAXimum|MINimum|DEFault]

## Returns

<NR2>

## Example

```
SWEep:FREQ:STOP 1 //Set the stop frequency of sweep to 1Hz.
SWEep:FREQ:STOP? //Query the presently set stop frequency.
SWEep:FREQ:STOP? MAX //Query the maximum value of the stop frequency.
```

## **SWEep:FREQ:STEP <NRf+>[,<NRf+>,<NRf+>]**

This command is used to set and query step frequency of sweep.

<NRf+>: step frequency setting value, or step frequency MINimum or MAXimum or DEFault setting.

Note:

In single-phase (including AC, ACDC, DC, DCAC), there is only one parameter; in three-phase, three parameters must be taken.

## Syntax

SWEep:FREQ:STEP <NRf+>[,<NRf+>,<NRf+>]

## Argument

<NRf+>[,<NRf+>,<NRf+>]

## \*RST

0

## Query syntax

SWEep:FREQ:STEP? [A|B|C][MAXimum|MINimum|DEFault]

## Returns

< NR2>

## Example

```
SWEep:FREQ:STEP 1 //Set the step frequency of sweep to 1Hz.
SWEep:FREQ:STEP? //Query the presently set step frequency.
SWEep:FREQ:STEP? MAX //Query the maximum value of step frequency.
```

## **SWEep:TIME:STEP <NRf+>[,<NRf+>,<NRf+>]**

This command is used to set and query the single-step execution time of sweep. It is valid when the mode is TIME.

<NRf+>: step time setting value, or step time MINimum or MAXimum or DEFault setting.

Note:

In single-phase (including AC, ACDC, DC, DCAC), there is only one parameter; in three-phase, three parameters must be taken.

## Syntax

SWEEp:TIME:STEP <NRf+>[,<NRf+>,<NRf+>]

## Argument

<NRf+>[,<NRf+>,<NRf+>]

## \*RST

0

## Query syntax

SWEEp:TIME:STEP? [A|B|C][MAXimum|MINimum|DEFAULT]

## Returns

<NR2>

## Example

```
SWEEp:TIME:STEP 1 //Set the step time of sweep to 1S.
SWEEp:TIME:STEP? //Query the presently set step time.
SWEEp:TIME:STEP? MAX //Query the maximum value of step time.
```

## SWEEp:MODE <mode>

This command is used to set and query the switching mode between the single steps of the sweep function, and it can be set to TIME or TRIG mode.

## Syntax

SWEEp:MODE <mode>

## Argument

TIME|TRIG

## \*RST

TIME

## Query syntax

SWEEp:MODE?

## Returns

TIME|TRIG

## Example

```
SWEEp:MODE TIME //Set sweep mode to TIME.
```

## SWEEp:PRIority<priority>

This command is used to set and query the priority of sweep.

<priority>: sweep priority VOLT|FREQ|VF|VOLT\_WAVE|FREQ\_WAVE|VF\_WAVE

## Syntax

SWEEp:PRlority<priority>

## Argument

VOLT|FREQ|VF|VOLT\_WAVE|FREQ\_WAVE|VF\_WAVE

## \*RST

VOLT

## Query syntax

SWEEp:PRlority?

## Returns

VOLT|FREQ|VF|VOLT\_WAVE|FREQ\_WAVE|VF\_WAVE

## Example

```
SWEEp:PRlority VOLT //Set the priority of sweep to VOLT.
SWEEp:PRlority?
```

## SWEEp:WAVeform <type>,<NR1>

This command is used to set and query the sweep waveform.

<type> sweep waveform

- Sine
- Square
- Saw
- Triangle
- Trapezoid
- Clipped-sine
- DST-01(30)
- Userdefined waveform

<NR1>: waveform number

## Syntax

SWEEp:WAVeform <type>,<NR1>

## Argument

<"Sine"|"Square"|"Triangle"|"Saw"|"Trapezoid"|"Clipped-sine"|"DST-01(30)"|"filename">

## \*RST

SINe

## Query syntax

SWEEp:WAVeform? <NR1>

## Returns

<"Sine"|"Square"|"Triangle"|"Saw"|"Trapezoid"|"Clipped-sine"|"DST-01(30)"|"filename">

## Example

```
SWEEp:WAVEform SINE,1 //Set sweep waveform to sine.
SWEEp:WAVEform? 1 //Query sweep waveform type.
```

## SWEEp:FINish <mode>

This command is used to set and query the end status of sweep.

<type>: sweep wave type NORMal|LAST|OFF

## Syntax

SWEEp:FINish <mode>

## Argument

NORMal|LAST|OFF

## \*RST

NORMal

## Query syntax

SWEEp:FINish?

## Returns

NORMal|LAST|OFF

## Example

```
SWEEp:FINish NORMal //Set the end state of sweep to NORMal.
SWEEp:FINish? //Query the end status of sweep.
```

## SWEEp:TRIG:SOURce <mode>

This command is used to set the trigger source of Sweep function.

## Syntax

SWEEp:TRIG:SOURce <mode>

## Argument

MANual|BUS|TRIG1|TRIG2

## \*RST

MANual

## Query syntax

SWEEp:TRIG:SOURce?

## Returns

MANual|BUS|TRIG1|TRIG2

## Example

SWEep:TRIG:SOURce MANual

## **SWEep:STEP:REPeat <NR1>**

Set the number of sweep repetitions, set 0 for infinite loop.

## Syntax

SWEep:STEP:REPeat <NR1>

## Argument

1-65535

## Query syntax

SWEep:STEP:REPeat? [MAXimum|MINimum]

## Example

SWEep:STEP:REPeat <NR1>

## **SWEep:SAVe <string>**

Save the sweep file.

## Syntax

SWEep:SAVe <string>

## Argument

<string>

## Example

SWEep:SAVe "sweep1.ini"

## **SWEep:RECall <string>**

Recall the sweep file.

## Syntax

SWEep:RECall <string>

## Argument

<string>

## Example

SWEep:RECall "sweep1.ini"

## **SWEep:STATe?**

This command is used to query the running status of sweep.

### Syntax

SWEep:STATe?

### Example

SWE:STAT?

## Chapter18 SURGesag Subsystem (Source)

### **SURGesag:MODE <mode>**

This command is used to set and query the surge/trap wave generating mode.

<mode>: surge/trap wave operating mode PERiod|TRIG.

PERiod generates surge/trap wave periodically, TRIG generates surge/trap wave when triggered.

#### Syntax

SURGesag:MODE <mode>

#### Argument

PERiod|TRIG

#### Query syntax

SURGesag:MODE?

#### Returns

PERiod|TRIG

#### Example

SURGesag:MODE PERiod //Set surge/trap wave generating mode to periodic mode.

SURGesag:MODE? // Query the surge/trap wave generating mode.

### **SURGesag:PHASe:STARt <NRf+>**

This command is used to set and query the initial phase of the surge/trap wave.

<NRf+>: start phase setting value, or start phase MINimum or MAXimum or DEFault setting.

#### Syntax

SURGesag:PHASe:STARt <NRf+>

#### Argument

<NRf+>

#### Unit

Degree (°)

#### \*RST

0

#### Query syntax

SURGesag:PHASe:STARt? [MAXimum|MINimum|DEFault]

## Returns

<NRf+>

## Example

```

SURGesag:PHASe:STARt 90 //Set the initial phase of the surge/trap wave
                           to 90°.
SURGesag:PHASe:STARt? //Query the presently set starting phase.
SURGesag:PHASe:STARt? MAX // Query the maximum value of the starting
                           phase.
    
```

## **SURGesag:PHASe:WIDTh <NRf+>**

This command is used to set and query the surge/trap wave angle width.

<NRf+>: angle width setting value

## Syntax

SURGesag:PHASe:WIDTh <NRf+>

## Argument

<NRf+>

## Unit

Degree (°)

## \*RST

0

## Query syntax

SURGesag:PHASe:WIDTh? [MAXimum|MINimum|DEFAULT]

## Returns

<NRf+>

## Example

```

SURGesag:PHASe:WIDTh 320.0 //Set the angular width to 320°.
SURGesag:PHASe:WIDTh? //Query the set value of angle width.
SURGesag:PHASe:WIDTh? MIN // Query the minimum value of the angle
                           width.
    
```

## **SURGesag:ACTion <action>**

This command is used to set and query the trigger action of the surge/trap wave.

<action>: trigger action setting mode IMMEDIATE|PHASe.

## Syntax

SURGesag:ACTion <action>

## Argument

IMMediate|PHASe

## \*RST

IMMediate

## Query syntax

SURGesag:ACTion?

## Returns

IMMediate|PHASe

## Example

SURGesag:ACTion IMMediate //Set the present trigger action to IMMediate.

SURGesag:ACTion IMMediate?

## **SURGesag:TRIG:SOURce <source>**

This command is used to set the trigger source of surge/sag function.

## Syntax

SURGesag:TRIG:SOURce <source>

## Argument

MANual|BUS|TRIG1|TRIG2

## Query syntax

SURGesag:TRIG:SOURce?

## Returns

MANual|BUS|TRIG1|TRIG2

## Example

SURGesag:TRIG:SOURce TRIG1

## **SURGesag:SYMMetry <bool>**

This command is used to set and query the symmetry mode switch of the surge/trap wave.

## Syntax

SURGesag:SYMMetry <bool>

## Argument

0 | OFF | 1 | ON

## \*RST

OFF

### Query syntax

SURGesag:SYMMetry?

### Returns

0 | OFF | 1 | ON

### Example

SURGesag:SYMMetry 1 //Turn on symmetry mode.

SURGesag:SYMMetry? //Query the switch status of symmetric mode.

## **SURGesag:REPeat:COUNT <NR1>**

This command is used to set and query the number of continuous surge/trap waves.

<NR1+>: set value of continuously generated surge/trap waves.

### Syntax

SURGesag:REPeat:COUNT <NR1>

### Argument

<NR1>

### \*RST

1

### Query syntax

SURGesag:REPeat:COUNT?

### Returns

<NR1>

### Example

SURGesag:REPeat:COUNT 5 //Set the number of continuous surge/trap waves to 5.

## **SURGesag:PERiod:COUNT <NR1>**

This command is used to set and query the period interval of the surge/trap wave occurrence.

<NR1+>: the period interval setting value of the surge/trap wave occurrence.

### Syntax

SURGesag:PERiod:COUNT <NR1>

### Argument

<NR1>

\*RST

1

Query syntax

SURGesag:PERiod:COUNT?

Returns

<NR1>

Example

SURGesag: PERiod:COUNT 5 //set the period interval of the surge/trap wave occurrence to 5.

## **SURGesag:VALue:SElect <mode>**

This command is used to set and query the setting mode of the surge/trap wave dropping value.

<mode>: the expression mode of the surge/trap wave dropping value  
PERCent|SETTing

Syntax

SURGesag:VALue:SElect <mode>

Argument

PERCent|SETTing

\*RST

PERCent

Query syntax

SURGesag:VALue:SElect <mode>

Returns

PERCent|SETTing

Example

SURGesag:VALue:SElect PERCent //Set the mode of the drop value to percent

SURGesag:VALue:SElect?

## **SURGesag:VALue:PERCent <NRf+>**

This command is used to set and query the percentage of the drop value of the surge/trap wave.

<NRf+>: dropping percentage setting value.

Syntax

SURGesag:VALue:PERCent <NRf+>

## Argument

<NRf+>

## \*RST

0

## Query syntax

SURGesag:VALue:PERCent?

## Returns

<NRf+>

## Example

```
SURGesag:VALue:PERCent 10 //Set the drop percentage to 10%
```

```
SURGesag:VALue:PERCent? //Query the set drop percentage
```

## **SURGesag:VALue <NRf+>**

This command is used to set and query the drop value of the trap wave.

<NRf+> drop set value

## Syntax

SURGesag:VALue <NRf+>

## Argument

<NRf+>

## \*RST

0

## Query syntax

SURGesag:VALue?

## Returns

<NRf+>

## Example

```
SURGesag:VALue 20 //Set the drop value to 20V
```

```
SURGesag:VALue? //Query the set value of the drop value
```

```
SURGesag:VALue? MAX //Query the maximum value of the drop set value.
```

## **SURGesag:PHASe:ENABLE <A|B|C|AB|AC|BC|ABC>**

This command is used to set and query the phase of surge/sag, available only in three-phase mode.

### Syntax

SURGesag:PHASe:ENABle <A|B|C|AB|AC|BC|ABC>

### Argument

<A|B|C|AB|AC|BC|ABC>

### Query syntax

SURGesag:PHASe:ENABle?

### Returns

<NRf+>

### Example

SURGesag:PHASe:ENABle ABC

## **SURGesag:ANGLE:ENABle <SYNC|SPEC>**

This command is used to set and query the synchronization method of dropping between three phases, SYNC means synchronous dropping, SPEC means dropping at the respective specified phase. Only available in three-phase mode.

### Syntax

SURGesag:ANGLE:ENABle < SYNC|SPEC >

### Argument

<SYNC|SPEC>

### Query syntax

SURGesag:ANGLE:ENABle?

### Returns

<NRf+>

### Example

SURGesag:ANGLE:ENABle SYNC

## **SURGesag:SAVe <string>**

Save the surge/sag file.

### Syntax

SURGesag:SAVe <string>

### Argument

<string>

### Example

SURGesag:SAVe "sweep1.ini"

## **SURGesag:RECall <string>**

Recall the surge/sag file.

### Syntax

SURGesag:RECall <string>

### Argument

<string>

### Example

SURGesag:RECall "sweep1.ini"

## **SURGesag:STATe?**

This command is used to query the running status of the surge/trap wave.

### Syntax

SURGesag:STATe?

### Example

SURGesag:STATe? //Query the running status of the surge/trap wave.

---

## Chapter19 SCOPE Subsystem (Source)

---

### SCOPE:AUTO

This is an automatic setting command of the oscilloscope.

#### Syntax

SCOPE:AUTO

#### Example

SCOPE:AUTO

### SCOPE:RUN

This is an operation command of the oscilloscope.

#### Syntax

SCOPE:RUN

#### Example

SCOPE:RUN

### SCOPE:SINGLE

This command is used to capture single-shot oscilloscope data.

#### Syntax

SCOPE:SINGLE

#### Example

SCOPE:SINGLE

### SCOPE:STOP

This is a stop command of the oscilloscope.

#### Syntax

SCOPE:STOP

#### Example

SCOPE:STOP

### SCOPE:TIMEbase:SCALE <NRf>

This command is used to set and query the time scale of the oscilloscope, unit: s.  
<0.001-1.0>

### Syntax

SCOPE:TIMEbase:SCALE <NRf>

### Argument

[MINimum|MAXimum]

### Query syntax

SCOPE:TIMEbase:SCALE?

### Returns

<NRf>

### Example

SCOPE:TIMEbase:SCALE 0.5

## **SCOPE:VOLTage:SCALE <NRf>**

This command is used to set and query the voltage scale of the oscilloscope, unit: V.

### Syntax

SCOPE:VOLTage:SCALE <NRf>

### Argument

[MINimum|MAXimum]

### Query syntax

SCOPE:VOLTage:SCALE?

### Returns

<NRf>

### Example

SCOPE:VOLTage:SCALE 10

## **SCOPE:CURREnt:SCALE <NRf>**

This command is used to set and query the current scale of the oscilloscope, unit: A.

### Syntax

SCOPE:CURREnt:SCALE <NRf>

### Argument

[MINimum|MAXimum]

### Query syntax

SCOPE:CURREnt:SCALE?

## Returns

<NRf>

## Example

SCOPE:CURRent:SCALE 30

## **SCOPE:TIMEbase:DELay <NRf>**

This command is used to set and query the trigger delay of the oscilloscope, unit: s.

## Syntax

SCOPE:TIMEbase:DELay <NRf>

## Argument

[MINimum|MAXimum]

## Query syntax

SCOPE:TIMEbase:DELay?

## Returns

<NRf>

## Example

SCOPE:TIMEbase:DELay 3

## **SCOPE:TRIGger:SOURce**

This command is used to set the trigger source of surge/sag function.

## Syntax

SCOPE:TRIGger:SOURce

## Argument

MANual|BUS|TRIG1|TRIG2

## Query syntax

SCOPE:TRIGger:SOURce?

## Returns

MANual|BUS|TRIG1|TRIG2

## Example

SCOPE:TRIGger:SOURce TRIG1

## **SCOPE:TRIGger:LEVel <NRf>**

This command is used to set and query the trigger level of the oscilloscope.

**Syntax**`SCOPE:TRIGger:LEVel <NRf>`**Argument**`[MINimum|MAXimum]`**Query syntax**`SCOPE:TRIGger:LEVel?`**Returns**`<NRf>`**Example**`SCOPE:TRIGger:LEVel MIN`**SCOPE:TRIGger:SLOPe <CPD>**

This command is used to set and query the trigger edge of the oscilloscope.

**Syntax**`SCOPE:TRIGger:SLOPe <CPD>`**Argument**`<RISE|FALL|BOTH>`**Query syntax**`SCOPE:TRIGger:SLOPe?`**Returns**`<RISE|FALL|BOTH>`**Example**`SCOPE:TRIGger:SLOPe BOTH`**SCOPE:TRIGger:MODE <CPD>**

This command is used to set and query the trigger mode of the oscilloscope.

**Syntax**`SCOPE:TRIGger:MODE <CPD>`**Argument**`<AUTO|NORMal>`**Query syntax**`SCOPE:TRIGger:MODE?`

## Returns

<AUTO|NORMAL>

## Example

SCOPE:TRIGger:MODE AUTO

## SCOPE:LINE:SELECTION

This command is used to set and query the curve displayed by the oscilloscope, up to 6 curves can be displayed.

## Syntax

SCOPE:LINE:SELECTION

## Argument

<1-6>,<Off|On|0|1>

## Query syntax

SCOPE:LINE:SELECTION?

## Example

SCOPE:LINE:SELECTION 1,ON

## SCOPE:STATUS?

Query the present status of the oscilloscope.

## Syntax

SCOPE:STATUS?

## Returns

"Stop"|"Ready"  
"Roll"|"Auto"|"Trig'd"

## Example

SCOPE:STATUS?

## SCOPE:RSTate?

Query the running status of the oscilloscope.

## Syntax

SCOPE:RSTate?

## Returns

"RUN"|"STOP"  
"SINGLE"

## Example

SCOPe:RSTate?

## SCOPe:WAVeform:DATA?

This command is used to get the data of the oscilloscope.

## Syntax

SCOPe:WAVeform:DATA?

## Example

SCOPe:WAVeform:DATA?

## SCOPe:RANGe:CATalog?

This command is used to get voltage and current scale range options.

## Syntax

SCOPe:RANGe:CATalog?

## Returns

2/5/10/20/50/100/200/500,0.2/0.5/1/2/5/10/20/50

## Example

SCOPe:RANGe:CATalog?

## SCOPe:RECOrd:LENGth <0.6|6|60|600>

Oscilloscope data points collected in one second, 0.6 that is 600 points, 600 that is 600000, with the time scale and sampling frequency, sampling frequency multiplied by the screen time scale to be less than or equal to the length of the record, such as, sampling frequency 6s, time scale 1s, the record length is set to 0.6kpts, then the collection of 100 points per second.

## Syntax

SCOPe:RECOrd:LENGth <0.6|6|60|600>

## Returns

<0.6|6|60|600>

## Query syntax

SCOPe:RECOrd:LENGth?

## Example

SCOPe:RECOrd:LENGth 6

## SCOPe:SAMPLe:MODE <NORMAl|PEAK>

This command is used to set sampling mode of Oscilloscope.

NORMAL: Acquisition of data points by equal interval mode

PEAK: Acquisition of data points by peak-to-peak mode

### Syntax

SCOPE:SAMPLE:MODE <NORMAL|PEAK>

### Argument

<NORMAL|PEAK>

### Query syntax

SCOPE:SAMPLE:MODE?

### Example

SCOPE:RECORD:LENGTH 6

## **SCOPE:DATA:TAG?**

Queries the sample data identification of the oscilloscope.

### Syntax

SCOPE:DATA:TAG?

### Returns

Return: <NR1>,<NR1> ,<NR1> ,<NR1> ,<NR1>

The first one is the starting point of the display

The second one shows the end time point

The third one is the data start time point

The fourth is the data end time point

The fifth is the data trigger time point

### Example

SCOPE:DATA:TAG?

## Chapter20 WAVEform Subsystem (Source)

### WAVEform[:IMMediate] <WAVEform>,[WAVEform],[WAVEform]

This command is used to set and query the waveform in Normal mode. For the waveform with parameters, the parameters are set to default values.

#### Syntax

WAVEform[:IMMediate] <WAVEform>,[WAVEform],[WAVEform]

#### Arguments

<"Sine"|"Square"|"Triangle"|"Saw"|"Trapezoid"|"Clipped-sine"|"DST-01(30)"|"file name">,  
 <"Sine"|"Square"|"Triangle"|"Saw"|"Trapezoid"|"Clipped-sine"|"DST-01(30)"|"file name">,  
 <"Sine"|"Square"|"Triangle"|"Saw"|"Trapezoid"|"Clipped-sine"|"DST-01(30)"|"file name">,  
 <"Sine"|"Square"|"Triangle"|"Saw"|"Trapezoid"|"Clipped-sine"|"DST-01(30)"|"file name">,>

#### \*RST

Sine

#### Query syntax

WAVEform?

#### Returns

<string>

#### Example

```
WAVE "Sine" // Set the waveform to Sine.
WAVE "Sine","Saw","Square" // Set three channel waveforms separately, valid
                             under three-phase unbalanced or multi-channel.
WAVE?
```

### PWAVEform[:IMMediate] <phase/chan>,<WAVEform>

This command is used to set and query the waveform of a phase/channel in Normal mode. For waveforms with parameters, the parameters are set to default values.

#### Syntax

PWAVEform[:IMMediate] <phase/chan>,<WAVEform>

#### Arguments

<A|B|C|CH1|CH2|CH3>,  
 <"Sine"|"Square"|"Triangle"|"Saw"|"Trapezoid"|"Clipped-sine"|"DST-01(30)"|"file name">

\*RST

Sine

Query syntax

PWAVEform? <phase/chan>

Returns

<string>

Example

```
PWAVE CH1,"Sine" // Set the channel 1 waveform of the current mode to Sine.
PWAVE A,"Sine"   // Set the phase A waveform of the current mode to Sine.
PWAVE? A         // Query the waveform of phase A.
PWAVE? CH1       // Query the waveform of channel 1.
```

### WAVEform:EDIT:PARAmeter <phase/chan>,<percent1>

This command is used to set and query the waveform parameters of a phase/channel (for example, the percentage of clipping wave. For waveform types without parameters, this parameter is invalid).

Syntax

WAVEform:EDIT:PARAmeter <phase/chan>,<percent1>

Arguments

<A|B|C|CH1|CH2|CH3>,<0-0.5>|<0-0.25>

Query syntax

WAVEform:EDIT:PARAmeter? <phase/chan>

Returns

<NRF>

Example

```
WAVE:EDIT:PAR 0.25,0.25,0.25
WAVE:EDIT:PAR? // Query waveform parameters of all phases/channels.
WAVE:EDIT:PAR? A //Query the waveform parameters of phase A.
WAVE:EDIT:PAR? CH1 // Query the waveform parameters of channel 1.
```

### WAVEform:EDIT:THD:CLEAr

This command is used to clear the edited memory data of the THD wave.

Syntax

WAVEform:EDIT:THD:CLEAr

## Example

```
WAVE:EDIT:THD:CLE
```

## **WAVEform:EDIT:THD:IMP**ort <filename>

This command is used to import the existing THD wave file into the editing memory and query the name of the THD wave file imported from the external storage.

## Syntax

```
WAVEform:EDIT:THD:IMP
```

ort <filename>

## Arguments

```
"filename"
```

## Query syntax

```
WAVEform:EDIT:THD:IMP?
```

## Returns

```
<string>
```

## Example

```
WAVE:EDIT:THD:IMP "Thd01.csv"
```

```
WAVE:EDIT:THD:IMP?
```

## **WAVEform:EDIT:THD:FORM**ula <formula>

This command is used to set and query the distortion factor calculation method of the edited THD wave.

## Syntax

```
WAVEform:EDIT:THD:FORM
```

ula <formula>

## Arguments

```
<%F|%R>
```

## Query syntax

```
WAVEform:EDIT:THD:FORM?
```

## Returns

```
<CPD>
```

## Example

```
WAVE:EDIT:THD:FORM %F
```

```
WAVE:EDIT:THD:FORM?
```

## **WAVEform:EDIT:THD:FUND**amental:PHASe <phase>

This command is used to set and query the initial phase of the THD waveform

base wave.

### Syntax

WAVEform:EDIT:THD:FUNDamental:PHASe <phase>

### Arguments

MAXimum|MINimum|DEFault

### Query syntax

WAVEform:EDIT:THD:FUNDamental:PHASe? [MAXimum|MINimum|DEFault]

### Returns

MAXimum|MINimum|DEFault

### Example

WAV:EDIT:THD:FUND:PHAS 30

WAV:EDIT:THD:FUND:PHAS?

## **WAVEform:EDIT:THD:DATA <order>,<string>**

This command is used to set and query the THD value and phase parameter of a certain order of harmonics

### Syntax

WAVEform:EDIT:THD:DATA <order>,<string>

### Arguments

<2-50>,<"thd,phase">

### Query syntax

WAVEform:EDIT:THD:DATA? <order>

### Returns

<string>

### Example

WAVE:EDIT:THD:DATA 2, "9.8,0.0"

WAVE:EDIT:THD:DATA? 2

## **WAVEform:EDIT:THD:SAVE:LOCAL <filename>**

This command is used to save the presently edited THD wave data to a local file, and specify the file name (if the file name is the same, it is regarded as modifying the present waveform, if the file name does not exist, it is regarded as creating a new file)

### Syntax

WAVEform:EDIT:THD:SAVE:LOCAL <filename>

## Arguments

"filename"

## Example

```
WAVE:EDIT:THD:SAVE:LOC "THD01.csv"
```

## **WAVEform:EDIT:THD:SAVE:UDISk <filename>**

This command is used to save the presently edited THD wave data to a U disk file, and specify the file name (if the file name is the same, it is regarded as modifying the current waveform, if the file name does not exist, it is regarded as creating a new file)

## Syntax

```
WAVEform:EDIT:THD:SAVE:UDISk <filename>
```

## Arguments

"filename"

## Example

```
WAVE:EDIT:THD:SAVE:UDIS "THD01.csv"
```

## **WAVEform:EDIT:THD:DELeTe <filename>**

This command is used to delete the custom THD waveforms file in the system.

## Syntax

```
WAVEform:EDIT:THD:DELeTe <filename>
```

## Arguments

"filename"

## Example

```
WAV:EDIT:THD:DEL "THD01.csv"
```

## **WAVEform:EDIT:THD:FILE:NUMBer?**

This command is used to get the number of THD custom waveform files (file\_number) stored locally on the device.

## Syntax

```
WAVEform:EDIT:THD:FILE:NUMBer?
```

## Example

```
WAV:EDIT:THD:FILE:NUMB?
```

## **WAVEform:EDIT:THD:FILE:NAME? <index>**

Query the name of THD waveform file stored locally on the device by index.

Note: Index values start at 0

## Syntax

WAVEform:EDIT:THD:FILE:NAME? <index>

## Arguments

0 - (file\_number-1)|MAXimum|MINimum

## Return

<NR1>

## Example

WAV:EDIT:THD:FILE:NAME? 2

## **WAVEform:EDIT:USERdefine:CLEAr**

This command is used to clear all of userdefined waveform data.

## Syntax

WAVEform:EDIT:USERdefine:CLEAr

## Example

WAVE:EDIT:USER:CLE

## **WAVEform:EDIT:USERdefine:IMPorT <filename>**

This command is used to import the data of the existing custom wave into the editing memory and query the file name of the imported userdefined wave.

## Syntax

WAVEform:EDIT:USERdefine:IMPorT <filename>

## Arguments

"filename"

## Query syntax

WAVEform:EDIT:USERdefine:IMPorT?

## Returns

<string>

## Example

WAVE:EDIT:USER:IMP "USER01"

WAVE:EDIT:USER:IMP?

## **WAVEform:EDIT:USERdefine:MODE <symmetry>**

This command is used to set and query the userdefined wave editing mode, where:

ASYM: The user can only edit the first 512 points, not symmetrical about the origin;

SYMM: The user can only edit the first 512 points, which are symmetrical about the origin;

FULL: users can customize and edit 1024 points in the entire cycle.

### Syntax

WAVEform:EDIT:USERdefine:MODE <symmetry>

### Arguments

<ASYM,SYMM,FULL>

### Query syntax

WAVEform:EDIT:USERdefine:MODE?

### Returns

<ASYM,SYMM,FULL>

### Example

WAVE:EDIT:USER:MODE ASYM

WAVE:EDIT:USER:MODE?

## **WAVEform:EDIT:USERdefine:DATA <index>,<normalization>**

Set and query the normalized point value of the point whose order is index.

### Syntax

WAVEform:EDIT:USERdefine:DATA <index>,<normalization>

### Arguments

<0-1023>,<0.0-1.0> (Note: The range of index varies with the presently set waveform editing mode (symmetrical attribute), FULL is 0-1023, and other modes are 0-511)

### Query syntax

WAVEform:EDIT:USERdefine:DATA? <index>

### Returns

<NR2>

### Example

WAVE:EDIT:USER:DATA 1,0.5

WAVE:EDIT:USER:DATA? 1

## **WAVEform:EDIT:USERdefine:SAVE:LOCAL <filename>**

This command is used to save the presently edited custom wave data to a file, and specify the file name (if the file name is the same, it is regarded as modifying the current waveform, if the file name does not exist, it is regarded as creating a new file)

## Syntax

WAVEform:EDIT:USERdefine:SAVE:LOCal <filename>

## Arguments

"filename"

## Example

WAVE:EDIT:USER:SAVE:LOC "USER01.csv"

## **WAVEform:EDIT:USERdefine:SAVE:UDISk <filename>**

This command is used to save the presently edited custom wave data to a USB disk file, and specify the file name (if the file name is the same, it is regarded as modifying the current waveform, if the file name does not exist, it is regarded as creating a new file)

## Syntax

WAVEform:EDIT:USERdefine:SAVE:UDISk <filename>

## Arguments

"filename"

## Example

WAVE:EDIT:USER:SAVE:UDIS "USER01.csv"

## **WAVEform:EDIT:USERdefine:DELeTe <filename>**

This command is used to delete the local userdefine waveform file in the system.

## Syntax

WAVEform:EDIT:USERdefine:DELeTe <filename>

## Example

WAV:EDIT:USER:DEL "USER01.csv"

## **WAVEform:EDIT:USERdefine:FILE:NUMBer?**

This command is used to get the number of userdefine waveform files (file\_number) stored locally on the device.

## Syntax

WAVEform:EDIT:USERdefine:FILE:NUMBer?

## Example

WAV:EDIT:USER:FILE:NUMB?

## **WAVEform:EDIT:USERdefine:FILE:NAME? <index>**

Query the name of userdefine waveform file stored locally on the device by index.

Note: Index values start at 0

## Syntax

WAVEform:EDIT:USERdefine:FILE:NAME? <index>

## Arguments

0 - (file\_number-1)|MAXimum|MINimum

## Return

<NR1>

## Example

WAV:EDIT:USER:FILE:NAME? 2

---

## Chapter21 ISLand Subsystem (Source)

---

### **ISLand:RUN:STATe?**

This command is used to query whether the instrument is in the island simulation state.

#### Syntax

ISLand:RUN:STATe?

#### Arguments

Null

#### Returns

IDLE|AC|ISLand|RLC

#### Example

ISL:RUN:STAT?

### **ISLand:TIME?**

This command is used to query the duration of island simulation state.

#### Syntax

ISLand:TIME?

#### Arguments

None

#### Returns

<NRF>

#### Example

ISLand:TIME?

### **ISLand:KEY1[:STATe] <CPD>**

This command is used to set the state of K1 key.

#### Syntax

ISLand:KEY1[:STATe] <CPD>

#### Arguments

None

#### Query syntax

ISLand:KEY1[:STATe]?

## Returns

0 | OFF | 1 | ON

## Example

ISLand:KEY1 1

ISLand:KEY1?

## **ISLand:KEY2:STATe] <CPD>**

This command is used to set the state of K2 key.

## Syntax

ISLand:KEY1[:STATe] <CPD>

## Arguments

None

## Query syntax

ISLand:KEY2[:STATe]?

## Returns

0 | OFF | 1 | ON

## Example

ISLand:KEY2 1

ISLand:KEY2?

## **ISLand:RESistance:LEVel <NRf+>[,A|B|C]**

This command is used to set the resistance R value of RLC load.

## Syntax

ISLand:RESistance:LEVel <NRf+>[,A|B|C]

## Arguments

<NRf+>

## Query syntax

ISLand:RESistance:LEVel? [A|B|C]

## Returns

MINimum | MAXimum | DEFault

## Example

ISLand:RESistance:LEVel 100

ISLand:RESistance:LEVel?

**ISLand:INDucatanCe:LEVel <NRf+>[,A|B|C]**

This command is used to set the inductance value of the RLC analog load.

## Syntax

```
ISLand:INDucatanCe:LEVel <NRf+>[,A|B|C]
```

## Arguments

<NRf+>

## Query syntax

```
ISLand:INDucatanCe:LEVel? [A|B|C]
```

## Returns

MINimum|MAXimum|DEFault

## Example

```
ISLand:INDucatanCe:LEVel 100
```

```
ISLand:INDucatanCe:LEVel?
```

**ISLand:PHASe:LEVel <NRf+>[,A|B|C]**

This command is used to set the island simulation start phase Angle.

## Syntax

```
ISLand:PHASe:LEVel <NRf+>[,A|B|C]
```

## Arguments

<NRf+>

## Query syntax

```
ISLand:PHASe:LEVel? [A|B|C]
```

## Returns

MINimum|MAXimum|DEFault

## Example

```
ISLand:PHASe:LEVel 90 //start at 90 degree
```

```
ISLand:PHASe:LEVel?
```

**ISLand:CAP:LEVel <NRf+>[,A|B|C]**

This command is used to set the capacitance value for island simulation.

## Syntax

```
ISLand:CAP:LEVel <NRf+>[,A|B|C]
```

## Arguments

<NRf+>

## Query syntax

ISLand:CAP:LEVel? [A|B|C]

## Returns

MINimum|MAXimum|DEFault

## Example

ISLand:CAP:LEVel 90

ISLand:CAP:LEVel?

## **ISLand:POWer:LEVel <NRf+>[,A|B|C]**

This command is used to set the active power value for island simulation.

## Syntax

ISLand:POWer:LEVel <NRf+>[,A|B|C]

## Arguments

<NRf+>

## Query syntax

ISLand:POWer:LEVel? [A|B|C]

## Returns

MINimum|MAXimum|DEFault

## Example

ISLand:POWer:LEVel 90

ISLand:POWer:LEVel?

## **ISLand:QL:LEVel <NRf+>[,A|B|C]**

This command is used to set the active power value of inductance load for island simulation.

## Syntax

ISLand:QL:LEVel <NRf+>[,A|B|C]

## Arguments

<NRf+>

## Query syntax

ISLand:QL:LEVel? [A|B|C]

## Returns

MINimum|MAXimum|DEFault

## Example

```
ISLand:QL:LEVel 90
```

```
ISLand:QL:LEVel?
```

## **ISLand:QC:LEVel <NRf+>[,A|B|C]**

This command is used to set the reactive power of the capacitive load for island simulation.

## Syntax

```
ISLand:QC:LEVel <NRf+>[,A|B|C]
```

## Arguments

<NRf+>

## Query syntax

```
ISLand:QC:LEVel? [A|B|C]
```

## Returns

MINimum|MAXimum|DEFault

## Example

```
ISLand:QC:LEVel 90
```

```
ISLand:QC:LEVel?
```

## **ISLand:MODE <CPD>[,CH1|CH2|CH3]**

This command is used to set the island simulation mode.

## Syntax

```
ISLand:MODE <CPD>[,CH1|CH2|CH3]
```

## Arguments

<RLC|P-Q>

## Query syntax

```
ISLand:MODE? [CH1|CH2|CH3]
```

## Returns

<RLC|P-Q>

## Example

```
ISLand:MODE RLC
```

```
ISLand:MODE?
```

## **ISLand:INHibit[:STATe] <CPD>**

This command is used to set the Island Inhibit Control function.

### Syntax

ISLand:INHibit[:STATe] <CPD>

### Arguments

0|OFF|1|ON

### Query syntax

ISLand:INHibit[:STATe]?

### Returns

0|1

### Example

ISLand:INHibit 0

ISLand:INHibit?

## **ISLand:VOLTage:CONTRol[:STATe] <CPD>[,CH1|CH2|CH3]**

This command is used to set the function of detecting the input voltage status during island simulation.

### Syntax

ISLand:VOLTage:CONTRol[:STATe] <CPD>[,CH1|CH2|CH3]

### Arguments

0|OFF|1|ON

### Query syntax

ISLand:VOLTage:CONTRol[:STATe]? [CH1|CH2|CH3]

### Returns

0|1

### Example

ISLand:VOLTage:CONTRol 0,CH1

ISLand:VOLTage:CONTRol?

## **ISLand:VOLTage:CONTRol:LEVeI <NRf+>[,A|B|C|CH1|CH2|CH3]**

This command is used to set the input voltage and set the voltage threshold when setting the island simulation.

### Syntax

ISLand:VOLTage:CONTRol:LEVeI <NRf+>[,A|B|C|CH1|CH2|CH3]

### Arguments

<NRf+>

### Query syntax

ISLand:VOLTage:CONTRol:LEVel? [A|B|C|CH1|CH2|CH3]

### Returns

MINimum|MAXimum|DEFault

### Example

ISLand:VOLTage:CONTRol:LEVel 200

ISLand:VOLTage:CONTRol:LEVel?

## **ISLand:CURRent:CONTRol[:STATe] <CPD>[,CH1|CH2|CH3]**

This command is used to set the function of detecting input current status during island simulation.

### Syntax

ISLand:CURRent:CONTRol[:STATe] <CPD>[,CH1|CH2|CH3]

### Arguments

0|OFF|1|ON

### Query syntax

ISLand:CURRent:CONTRol[:STATe]? [CH1|CH2|CH3]

### Returns

0|1

### Example

ISLand:CURRent:CONTRol 0,CH2

ISLand:CURRent:CONTRol?

## **ISLand:CURRent:CONTRol:LEVel <NRf+>[,A|B|C|CH1|CH2|CH3]**

This command is used to set the current threshold to detect the input current during island simulation.

### Syntax

ISLand:CURRent:CONTRol:LEVel <NRf+>[,A|B|C|CH1|CH2|CH3]

### Arguments

<NRf+>

### Query syntax

ISLand:CURRent:CONTRol:LEVel? [A|B|C|CH1|CH2|CH3]

### Returns

MINimum|MAXimum|DEFault

## Example

```
ISLand:CURRent:CONTRol:LEVel 1
ISLand:CURRent:CONTRol:LEVel?
```

## **ISLand:POWer:CONTRol[:STATe] <CPD>[,CH1|CH2|CH3]**

This command is used to set the function of detecting the input power status during island simulation.

## Syntax

```
ISLand:POWer:CONTRol[:STATe] <CPD>[,CH1|CH2|CH3]
```

## Arguments

```
0|OFF|1|ON
```

## Query syntax

```
ISLand:POWer:CONTRol[:STATe]? [CH1|CH2|CH3]
```

## Returns

```
0|1
```

## Example

```
ISLand:POWer:CONTRol 0,CH2
ISLand:CURRent:CONTRol?
```

## **ISLand:POWer:CONTRol:LEVel <NRf+>[,A|B|C|CH1|CH2|CH3]**

This command is used to set the power threshold to detect the input power during island simulation.

## Syntax

```
ISLand:POWer:CONTRol:LEVel <NRf+>[,A|B|C|CH1|CH2|CH3]
```

## Arguments

```
<NRf+>
```

## Query syntax

```
ISLand:POWer:CONTRol:LEVel? [A|B|C|CH1|CH2|CH3]
```

## Returns

```
MINimum|MAXimum|DEFault
```

## Example

```
ISLand:POWer:CONTRol:LEVel 1000
ISLand:POWer:CONTRol:LEVel?
```

## Chapter22 Current Source Subsystem

### **[SOURce:]CURRent[:LEVel][:IMMediate][:AMPLitude][:AC] <NRf+>**

This command is used to set the current RMS value.

#### Syntax

[SOURce:]CURRent[:LEVel][:IMMediate][:AMPLitude][:AC] <NRf+>

#### Arguments

NRf+

#### Returns

MAXimum|MINimum|DEFault

#### Example

CURRent 90

#### Query syntax

CURRent[:LEVel][:IMMediate][:AMPLitude][:AC]? [MAXimum|MINimum|DEFault]

### **[SOURce:]CURRent[:LEVel][:IMMediate][:AMPLitude]:DC <NRf+>**

This command is used to set the current dc value.

#### Syntax

[SOURce:]CURRent[:LEVel][:IMMediate][:AMPLitude]:DC <NRf+>

#### Arguments

NRf+

#### Returns

MAXimum|MINimum|DEFault

#### Example

CURRent:DC 30

#### Query syntax

CURRent[:LEVel][:IMMediate][:AMPLitude]:DC? [MAXimum|MINimum|DEFault]

### **[SOURce:]CURRent:SLOPe[:IMMediate][:AC] <NRf+>**

This command is used to set the current slope.

## Syntax

[SOURce:]CURRent:SLOPe[:IMMEDIATE][:AC] <NRf+>

## Arguments

NRf+

## \*RST

1000.00A/ms

## Returns

MAXimum|MINimum|DEFault

## Example

CURRent:SLOPe 2000

## Query syntax

CURRent:SLOPe[:IMMEDIATE][:AC]? [MAXimum|MINimum|DEFault]

## **[SOURce:]CURRent:SLOPe[:IMMEDIATE]:DC <NRf+>**

This command is used to set the Idc slope.

## Syntax

CURRent:SLOPe[:IMMEDIATE]:DC <NRf+>

## Arguments

NRf+

## \*RST

1000.00A/ms

## Returns

MAXimum|MINimum|DEFault

## Example

CURRent:SLOPe:DC 2000

## Query syntax

CURRent:SLOPe[:IMMEDIATE]:DC? [MAXimum|MINimum|DEFault]

## **[SOURce:]FREQuency[:IMMEDIATE] <NRf+>**

This command is used to set the frequency in Normal mode.

<NRf+> frequency value

## Syntax

FREQuency[:IMMEDIATE] <NRf+>

## Arguments

NRf+

## \*RST

1000.00A/ms

## Returns

MAXimum|MINimum|DEFault

## Example

```
SOURce:FREQuency 300.0 //set the frequency to 300.0Hz
FREQuency 300.0 //set the frequency to 300.0Hz
```

## Query syntax

FREQuency[:IMMediate]? [MAXimum|MINimum| DEFault]

## **[SOURce:]FREQuency:SLOPe[:IMMediate] <NRf+>**

This command is used to set the frequency slope in Normal mode.

## Syntax

[SOURce:]FREQuency:SLOPe[:IMMediate] <NRf+>

## Arguments

0.00001-500000.000

## \*RST

1000.00Hz/ms

## Returns

MAXimum|MINimum|DEFault

## Example

```
SOURce:FREQuency:SLOPe 300.0
FREQ:SLOP 300.0
```

## Query syntax

FREQuency:SLOPe[:IMMediate]? [MAXimum|MINimum| DEFault]

## **[SOURce:]DIMMing[:STATe] <CPD>[,CH1|CH2|CH3]**

This command is used to set the dimming function switch.

## Syntax:

DIMMing[:STATe] <CPD>[,CH1|CH2|CH3]

## Arguments:

0|OFF|1|ON

## Query syntax:

DIMMING[:STATE]? [CH1|CH2|CH3]

## Returns:

0|1

## Example:

DIMMING 1,2

DIMMING? 1

**[SOURCE:]DIMMING:EDGE <CPD>[,CH1|CH2|CH3]**

This command is used to set the dimming edge.

## Syntax:

DIMMING:EDGE &lt;CPD&gt;[,CH1|CH2|CH3]

## Arguments:

FRONT|BACK

## Query syntax:

DIMMING:EDGE? [CH1|CH2|CH3]

## Returns:

FRONT|BACK

## Example:

DIMMING:EDGE FRON,1

DIMMING:EDGE? 1

**[SOURCE:]DIMMING:PHASE <NRf>[,CH1|CH2|CH3]**

This command is used to set dimming phase.

## Syntax:

DIMMING:PHASE &lt;NRf&gt;[,CH1|CH2|CH3]

## Arguments:

MAXimum|MINimum|DEFault

## Query syntax:

DIMMING:PHASE? [CH1|CH2|CH3]

Returns:

MAXimum|MINimum|DEFault

Example:

DIMMING:PHASe 180,1

## **[SOURCE:]EXtern:PROGrama[:STATE] <CPD>**

This command is used to set external programming function status.

Syntax:

EXtern:PROGrama[:STATE] <CPD>

Arguments:

0|OFF|1|ON

Query syntax:

EXtern:PROGrama[:STATE]?

Example

EXT:PROG ON

EXT:PROG?

## **[SOURCE:]EXtern:PROGrama:MODE <CPD>**

This command is used to set the external programming mode.

Syntax:

EXtern:PROGrama:MODE <CPD>

Arguments:

AM|INSTant

Query syntax:

EXtern:PROGrama:MODE?

Example

EXT:PROG:MODE INSTant

EXT:PROG:MODE?

## **[SOURCE:]EXtern:MONitor:PHASe <phase>**

This command is used to set which phase to monitor, applicable when three-phase and multi-channel configurations are employed.

Syntax:

EXtern:MONitor:PHASe <phase>

**Arguments:**

A|B|C

**Query syntax:**

EXTern:MONitor:PHASe?

**Example**

EXTern:MONitor:PHASe A

EXTern:MONitor:PHASe?

**[SOURCE:]EXTern:PROGrama:VOLTage:RANGe <range>**

This command sets the voltage range for external simulation. Selectable ranges are 50V/1 or 100V/1.

This setting applies to both external simulation and external voltage monitoring.

**Syntax:**

EXTern:PROGrama:VOLTage:RANGe &lt;range&gt;

**Arguments:**

50V/1V|100V/1V|Self-defined

**Query syntax:**

EXTern:PROGrama:VOLTage:RANGe?

**Example**

EXTern:PROGrama:VOLTage:RANGe 50V/1V

EXTern:PROGrama:VOLTage:RANGe?

**[SOURCE:]EXTern:PROGrama:CURRent:RANGe <range>**

Set the current range. Two options are available: 0-5A/1V or 1-10A/1V.

**Syntax:**

EXTern:PROGrama:CURRent:RANGe &lt;range&gt;

**Arguments:**

0-5A/1V or 1-10A/1V

**Query syntax:**

EXTern:PROGrama:CURRent:RANGe?

**Example**

EXTern:PROGrama:CURRent:RANGe 5A/1V

**[SOURCE:]EXTern:PROGrama:VOLTage:SELF <NRf+>**

This command is used to set the custom voltage ratio.

Range: 0~128

Syntax:

EXTern:PROGram:VOLTage:SELF <NRf+>

Arguments:

0~128

Query syntax:

EXTern:PROGram:VOLTage:SELF?

Example

EXTern:PROGram:VOLTage:SELF 10

## **[SOURCE:]CONFIGure:HARMonic:THD:FORMula <CPD>**

This command is used to configure the harmonic distortion calculation formula. Should the fundamental (1st-order) component data serve as the denominator (f%) or should all harmonic measurement data serve as the denominator (r%)?

Syntax:

CONFigure:HARMonic:THD:FORMula <CPD>

Arguments:

FUNDamental|TOTAl

Query syntax:

CONFigure:HARMonic:THD:FORMula?

Example

CONF:HARM:THD:FORM TOTAl

## **[SOURCE:]CONFIGure:HARMonic:TABLE:TYPE <CPD>**

This command is used to set the display type for the harmonic distortion list.

Syntax:

CONFigure:HARMonic:TABLE:TYPE <CPD>

Arguments:

<ALL|EVEN|ODD>

Query syntax:

CONFigure:HARMonic:TABLE:TYPE?

\*RST:

ALL

## Example

```
CONF:HARM:TABL:TYPE ODD
```

## [SOURCE:]CONFigure:HARMonic:TABLE:SElect <CPD>

This command is used to select the data type for the harmonic distortion list, choosing between voltage harmonics or current harmonics.

## Syntax:

```
CONFigure:HARMonic:TABLE:SElect <CPD>
```

## Arguments:

```
<U|I>
```

## Query syntax:

```
CONFigure:HARMonic:TABLE:SElect?
```

## Example

```
CONF:HARM:TABL:SEL U
```

## [SOURCE:]FUNcTion <CPD1>

This command is used to configure the device's operating mode.

## Syntax:

```
FUNcTion <CPD1>[,CPD2]
```

## Arguments:

```
CPD1:AC|ACDC
```

## Query syntax:

```
FUNcTion? [CH1|CH2|CH3]
```

## Returns:

```
CPD1:AC|ACDC
```

## \*RST:

```
AC
```

## Example

```
FUNC AC
```

## [SOURCE:]CURRent:LIMit:HIGH <NRf+>

This command is used to set the upper limit value for the RMS current protection, invalid in DCAC/DC mode.

## Syntax:

```
CURRent:LIMit:HIGH <NRf+>
```

**Arguments:**

MAXimum|MINimum|DEFault

**Query syntax:**

CURRent:LIMit:HIGH? [MAXimum|MINimum| DEFault]

**Returns:**

NRf+

**Example**

CURRent:LIMit:HIGH 90

**[SOURce:]CURRent:LIMit:LOW <NRf+>**

This command is used to set the lower limit value for RMS current protection, invalid in DCAC/DC mode

**Syntax:**

CURRent:LIMit:LOW &lt;NRf+&gt;

**Arguments:**

MAXimum|MINimum|DEFault

**Query syntax:**

CURRent:LIMit:LOW? [MAXimum|MINimum| DEFault]

**Returns:**

NRf+

**Example**

CURRent:LIMit:LOW 30

**[SOURce:]CURRent:LIMit:DELay <NRf+>**

This command is used to set the current RMS protection delay time. Unit: S

**Syntax:**

CURRent:LIMit:LOW &lt;NRf+&gt;

**Arguments:**

MAXimum|MINimum|DEFault

**Query syntax:**

CURRent:LIMit:DELay? [MAXimum|MINimum| DEFault]

**Returns:**

NRf+

## Example

```
CURRent:LIMit:DELay 10
```

**[SOURce:]CURRent:LIMit:DELay <NRf+>**

This command is used to set the current RMS protection delay time. Unit: S

## Syntax:

```
CURRent:LIMit:LOW <NRf+>
```

## Arguments:

```
MAXimum|MINimum|DEFault
```

## Query syntax:

```
CURRent:LIMit:DELay? [MAXimum|MINimum| DEFault]
```

## Returns:

```
NRf+
```

## Example

```
CURRent:LIMit:DELay 10
```

**[SOURce:]VOLTage:LIMit:HIGh <NRf+>**

Set the voltage upper limit value; in AC mode, this is used to set the peak voltage upper limit.

## Syntax:

```
VOLTage:LIMit:HIGh <NRf+>
```

## Arguments:

```
MAXimum|MINimum|DEFault
```

## Query syntax:

```
VOLTage:LIMit:HIGh?[MAXimum|MINimum|DEFault]
```

## Returns:

```
MAXimum|MINimum|DEFault
```

## Example:

```
VOLTage:LIMit:HIGh 300
```

**[SOURce:]VOLTage:LIMit:LOW <NRf+>**

DC mode sets the voltage lower limit. Invalid in AC mode.

## Syntax:

```
VOLTage:LIMit:LOW <NRf+> [,CH1|CH2|CH3]
```

**Arguments:**

MAXimum|MINimum|DEFault

**Query syntax:**

VOLTage:LIMit:LOW? [MAXimum|MINimum|DEFault]

**Returns:**

MAXimum|MINimum|DEFault

**Example:**

VOLTage:LIMit:LOW -11

**[SOURce:]POWER:LIMit:HIGH <NRf+>**

Set the upper limit for power protection, invalid in DCAC/DC mode

**Syntax:**

POWER:LIMit:HIGH <NRf+>

**Arguments:**

MAXimum|MINimum|DEFault

**Query syntax:**

POWER:LIMit:HIGH? [,MAXimum|MINimum|DEFault]

**Example**

POWER:LIMit:HIGH 2000

**[SOURce:]POWER:LIMit:LOW <NRf+>**

This command sets the lower limit for power protection, invalid in DCAC/DC mode

**Syntax:**

POWER:LIMit:LOW <NRf+>

**Arguments:**

MAXimum|MINimum|DEFault

**Query syntax:**

POWER:LIMit:LOW? [,MAXimum|MINimum|DEFault]

**Example**

POWER:LIMit:LOW -10

**[SOURce:]POWER:LIMit:DELay <NRf+>**

This command sets the power protection delay time in seconds.

**Syntax:**`POWer:LIMit:DELay <NRf+>`**Arguments:**`MAXimum|MINimum|DEFault`**Query syntax:**`POWer:LIMit:DELay? [,MAXimum|MINimum|DEFault]`**Example**`POWer:LIMit:DELay 3`

## Chapter23 Current OUTPut Subsystem

### **[SOURce:]CURRent:OUTPut[:STATe] <state>**

Set the output state in current source mode.

#### Syntax

[SOURce:]CURRent:OUTPut[:STATe] <state>

#### Arguments

0|OFF|1|ON

#### Returns

0|OFF|1|ON

#### Example

CURR:OUTP 1

#### Query syntax

[SOURce:]CURRent:OUTPut[:STATe]?

### **[SOURce:]CURRent:OUTPut:PROTection:CLEAr**

Clear the protection status in current source mode.

#### Syntax

[SOURce:]CURRent:OUTPut:PROTection:CLEAr

#### Arguments

Null

#### Returns

Null

#### Example

CURR:OUTP:PROT:CLE

### **[SOURce:]CURRent:OUTPut:OFF:MODE <CPD>**

Set the output mode when the machine is OFF:

- OPENz
- HIGHz
- SHORT

#### Syntax

[SOURce:]CURRent:OUTPut:OFF:MODE <CPD>

## Arguments

OPENz|HIGHz|SHORTt

## Returns

OPENz|HIGHz|SHORTt

## Example

CURR:OUTP:OFF:MODE OPEN

## Query syntax

[SOURce:]CURRent:OUTPut:OFF:MODE?

## **[SOURce:]CURRent:OUTPut:ON:PHASe:MODE <CPD>**

Set the machine's startup phase mode:

- PHASe
- IMMEDIATE
- SLOPe

## Syntax

[SOURce:]CURRent:OUTPut:ON:PHASe:MODE <CPD>

## Arguments

PHASe|IMMEDIATE

## Returns

PHASe|IMMEDIATE

## Example

CURRent:OUTPut:ON:PHASe:MODE PHASe

## Query syntax

[SOURce:]CURRent:OUTPut:ON:PHASe:MODE?

## **[SOURce:]CURRent:OUTPut:ON:PHASe:LEVEl <NRf+>**

Set the machine's startup phase value:

When the machine's start-up phase mode is set to PHASe, the machine will begin outputting at that phase when ON.

## Syntax

[SOURce:]CURRent:OUTPut:ON:PHASe:LEVEl <NRf+>

## Arguments

MINimum|MAXimum|DEFault

## Returns

MINimum|MAXimum|DEFault

## Example

CURR:OUTP:ON:PHAS:LEVeL 30

## Query syntax

[SOURce:]CURRent:OUTPut:ON:PHASe:LEVeL?

## **[SOURce:]CURRent:OUTPut:OFF:PHASe:MODE <CPD>**

Set the machine shutdown phase mode:

- PHASe
- IMMEDIATE
- SLOPe

## Syntax

[SOURce:]CURRent:OUTPut:OFF:PHASe:MODE <CPD>

## Arguments

PHASe|IMMEDIATE

## Returns

PHASe|IMMEDIATE

## Example

CURRent:OUTPut:OFF:PHASe:MODE PHAS

## Query syntax

[SOURce:]CURRent:OUTPut:OFF:PHASe:MODE?

## **[SOURce:]CURRent:OUTPut:OFF:PHASe:LEVeL <NRf+>**

Set the machine shutdown phase value:

When the machine's output off angle mode is set to PHASe, the machine will shut down the output at that phase when OFF.

## Syntax

[SOURce:]CURRent:OUTPut:OFF:PHASe:LEVeL <NRf+>

## Arguments

MINimum|MAXimum|DEFault

## Returns

MINimum|MAXimum|DEFault

### Example

```
CURR:OUTP:OFF:PHAS:LEVel 30
```

### Query syntax

```
[SOURce:]CURRent:OUTPut:OFF:PHASe:LEVel?
```

## **[SOURce:]CURRent:OUTPut:ALC[:STATe] <CPD>**

Set the ALC status.

### Syntax

```
[SOURce:]CURRent:OUTPut:ALC[:STATe] <CPD>
```

### Arguments

```
0|OFF|1|ON
```

### Returns

```
0|OFF|1|ON
```

### Example

```
CURRent:OUTPut:ALC 1
```

### Query syntax

```
[SOURce:]CURRent:OUTPut:ALC[:STATe]?
```

# Chapter24 Current Fetch/Measure Subsystem

---

## **FETCh[:SCALar]:CURRent[:AC]?**

## **MEASure[:SCALar]:CURRent[:AC]?**

This command is used to read the current effective value.

Syntax:

```
FETCh[:SCALar]:CURRent?  
MEASure[:SCALar]:CURRent[:AC]?
```

Returns:

<NRf>

Example:

```
FETC:CURR?  
MEAS:CURR?
```

## **FETCh[:SCALar]:CURRent:DC?**

## **MEASure[:SCALar]:CURRent:DC?**

This command is used to read the direct current component.

Syntax:

```
FETCh[:SCALar]:CURRent?]  
MEASure[:SCALar]:CURRent:DC?
```

Returns:

<NRf>

Example:

```
FETC:CURR:DC?  
MEAS:CURR:DC?
```

## **FETCh[:SCALar]:CURRent:AMPLitude:MAXimum:POSitive?**

## **MEASure[:SCALar]:CURRent:AMPLitude:MAXimum:POSitive?**

This command is used to read the positive peak value of the current.

**Syntax:**

```
FETCh[:SCALar]:CURRent:AMPlitude:MAXimum:POSitive?  
[A|B|C|CH1|CH2|CH3]  
MEASure[:SCALar]:CURRent:AMPlitude:MAXimum:POSitive?  
[A|B|C|CH1|CH2|CH3]
```

**Returns:**

```
<NRf>...
```

**Example:**

```
FETC:CURR:AMP:MAX:POS?  
MEAS:CURR:AMP:MAX:POS?
```

**FETCh[:SCALar]:CURRent:AMPlitude:MAXimum:NEGative?****MEASure[:SCALar]:CURRent:AMPlitude:MAXimum:NEGative?**

This command is used to read the negative peak value of the current.

**Syntax:**

```
FETCh[:SCALar]:CURRent:AMPlitude:MAXimum:NEGative?  
MEASure[:SCALar]:CURRent:AMPlitude:MAXimum:NEGative?
```

**Returns:**

```
<NRf>...
```

**Example:**

```
FETC:CURR:AMP:MAX:NEG?
```

**FETCh[:SCALar]:CURRent:AMPlitude:MAXimum?****MEASure[:SCALar]:CURRent:AMPlitude:MAXimum?**

This command is used to read the current peak value.

**Syntax:**

```
FETCh[:SCALar]:CURRent:AMPlitude:MAXimum?  
MEASure[:SCALar]:CURRent:AMPlitude:MAXimum?
```

**Returns:**

```
<NRf>...
```

**Example:**

```
FETC:CURR:AMP:MAX?
```

## **FETCh[:SCALar]:CURRent:AMPLitude:MAXimum:HOLD?**

## **MEASure[:SCALar]:CURRent:AMPLitude:MAXimum:HOLD?**

This command is used to read the current peak hold value. It will automatically reset to zero upon the next power-up.

### Syntax:

```
FETCh[:SCALar]:CURRent:AMPLitude:MAXimum:HOLD?  
MEASure[:SCALar]:CURRent:AMPLitude:MAXimum:HOLD?
```

### Returns:

```
<NRf>...
```

### Example:

```
FETC:CURR:AMP:MAX:HOLD?  
MEAS:CURR:AMP:MAX:HOLD?
```

## **FETCh[:SCALar]:CURRent:CFACtor?**

## **MEASure[:SCALar]:CURRent:CFACtor?**

This command is used to read the peak current factor value.

### Syntax:

```
FETCh[:SCALar]:CURRent:CFACtor?  
MEASure[:SCALar]:CURRent:CFACtor?
```

### Returns:

```
<NRf>...
```

### Example:

```
FETC:CURR:CFAC?
```

## **FETCh[:SCALar]:FREQUency?**

## **MEASure[:SCALar]:FREQUency?**

This command is used to read the frequency value.

### Syntax:

```
FETCh[:SCALar]:FREQUency?  
MEASure[:SCALar]:FREQUency?
```

Returns:

<NRf>...

Example:

FETC:FREQ?

FETC:FREQ?

## **FETCh[:SCALar]:POWer[:REAL]?**

## **MEASure[:SCALar]:POWer[:REAL]?**

This command is used to read the active power value.

Syntax:

FETCh[:SCALar]:POWer [:REAL]?

MEASure[:SCALar]:POWer[:REAL]?

Returns:

<NRf>...

Example:

FETC:POWer?

## **FETCh[:SCALar]:POWer:APParent?**

## **MEASure[:SCALar]:POWer:APParent?**

This command is used to read the apparent power value.

Syntax:

FETCh[:SCALar]:POWer:APParent?

MEASure[:SCALar]:POWer:APParent?

Returns:

<NRf>...

Example:

FETC:POW:APP?

## **FETCh[:SCALar]:POWer:REACTive?**

## **MEASure[:SCALar]:POWer:REACTive?**

This command is used to read the reactive power value.

**Syntax:**

FETCh[:SCALar]:POWer:REACtive?  
MEASure[:SCALar]:POWer:REACtive?

**Returns:**

<NRf>...

**Example:**

FETC:POW:REAC?

## **FETCh[:SCALar]:POWer:PFACtor?**

## **MEASure[:SCALar]:POWer:PFACtor?**

This command is used to read the power factor value.

**Syntax:**

FETCh[:SCALar]:POWer:PFACtor?  
MEASure[:SCALar]:POWer:PFACtor?

**Returns:**

<NRf>...

**Example:**

FETC:POW:PFAC?  
MEAS:POW:PFAC?

## **FETCh[:SCALar]:VOLTage[:AC]?**

## **MEASure[:SCALar]:VOLTage[:AC]?**

This command is used to read the effective value of the voltage.

**Syntax:**

FETCh[:SCALar]:VOLTage?  
MEASure[:SCALar]:VOLTage[:AC]?

**Returns:**

<NRf>...

**Example:**

FETC:VOLT?

## **FETCh[:SCALar]:VOLTage:DC?**

## **MEASure[:SCALar]:VOLTage:DC?**

This command is used to read the DC voltage component.

### Syntax:

FETCh[:SCALar]:VOLTage:DC?

MEASure[:SCALar]:VOLTage:DC?

### Returns:

<NRf>

### Example:

FETC:VOLT:DC?

## **FETCh[:SCALar]:VOLTage:AMPLitude:MAXimum?**

## **MEASure[:SCALar]:VOLTage:AMPLitude:MAXimum?**

This command is used to read the voltage peak.

### Syntax:

FETCh[:SCALar]:VOLTage:AMPLitude:MAXimum?

MEASure[:SCALar]:VOLTage:AMPLitude:MAXimum?

### Returns:

<NRf>...

### Example:

FETC:VOLT:AMP:MAX?

## **FETCh[:SCALar]:VOLTage:AMPLitude:MAXimum:POSitive?**

## **MEASure[:SCALar]:VOLTage:AMPLitude:MAXimum:POSitive?**

This command is used to read the positive voltage peak value.

### Syntax:

FETCh[:SCALar]:VOLTage:AMPLitude:MAXimum:POSitive?

MEASure[:SCALar]:VOLTage:AMPLitude:MAXimum:POSitive?

### Returns:

<NRf> ...

Example:

FETC:VOLT:AMP:MAX:POS?

**FETCh[:SCALar]:VOLTage:AMPLitude:MAXimum:NEGative?**

**MEASure[:SCALar]:VOLTage:AMPLitude:MAXimum:NEGative?**

This command is used to read the negative voltage peak.

Syntax:

FETCh[:SCALar]:VOLTage:AMPLitude:MAXimum:NEGative?

MEASure[:SCALar]:VOLTage:AMPLitude:MAXimum:NEGative?

Returns:

<NRf> ...

Example:

FETC:VOLT:AMP:MAX:NEG?

**FETCh[:SCALar]:VOLTage[:AC][:AMPLitude]:MAXimum:HOLD? [A]**

**MEASure[:SCALar]:VOLTage[:AC][:AMPLitude]:MAXimum:HOLD? [A]**

This command is used to read the peak hold value of Phase A voltage. It will automatically reset to zero upon the next power-up.

Syntax:

FETCh[:SCALar]:VOLTage[:AC][:AMPLitude]:MAXimum:HOLD? [A]

MEASure[:SCALar]: VOLTage[:AC][:AMPLitude]:MAXimum:HOLD? [A]

Returns:

<NRf> ...

Example:

FETC:VOLT:MAX:HOLD?

**FETCh[:SCALar]:VOLTage[:AC][:AMPLitude]:MAXimum:HOLD:CLEar [A]**

**MEASure[:SCALar]:VOLTage[:AC][:AMPLitude]:MAXimum:HOLD:CLEar [A]**

This command is used to clear the single-phase voltage peak hold value.

Syntax:

FETCh[:SCALar]:VOLTage[:AC][:AMPLitude]:MAXimum:HOLD:CLEar [A]

MEASure[:SCALar]:VOLTage[:AC][:AMPLitude]:MAXimum:HOLD:CLEar [A]

Returns:

<NRf> ...

Example:

FETC:VOLT:MAX:HOLD:CLE

## FETCh[:SCALar]?

## MEASure[:SCALar]?

This command is used to retrieve all METER data.

Syntax:

FETCh[:SCALar]?  
MEASure[:SCALar]?

Returns:

<NRf> ...

Example:

FETCh? command parameter [A] is optional (may be omitted), returning <float>,...,<float>(17+2=19 floating-point measurements). The 19 floating-point measurements are sequentially:

(Urms,Irms,P,Upp,Upn,Ipp,Ipn,Freq,CF,PF,S,Q,Udc,Idc,Uthd,Ipeak,Ithd,Uac,Iac,)

The MEASure? command parameter [A] is optional (may be omitted), returning <float>,...,<float>(17 floating-point measurement values). The 17 floating-point measurement values are, in sequence:

(Uac,Iac,P,Upp,Upn,Ipp,Ipn,Freq,CF,PF,S,Q,Udc,Idc,Uthd,Ipeak,Ithd)

## FETCh[:SCALar]:VOLTage:HARMonic[:AMPLitude]? <NR1>

## MEASure[:SCALar]:VOLTage:HARMonic[:AMPLitude]? <NR1>

This command is used to measure the amplitude of voltage harmonics.

Syntax:

FETCh[:SCALar]:VOLTage:HARMonic[:AMPLitude]? <NR1>  
MEASure[:SCALar]:VOLTage:HARMonic[:AMPLitude]? <NR1>

Arguments:

NR1: 0-50

Returns:

<NRf>

Example:

FETC:VOLT:HARM? 4

**FETCh[:SCALar]:CURRent:HARMonic[:AMPLitude]?  
<NR1>**

**MEASure[:SCALar]:CURRent:HARMonic[:AMPLitude]?  
<NR1>**

This command is used to measure the amplitude of current harmonics.

Syntax:

FETCh[:SCALar]:CURRent:HARMonic[:AMPLitude]? <NR1>

MEASure[:SCALar]:CURRent:HARMonic[:AMPLitude]? <NR1>

Arguments:

NR1: 0-50

Returns:

<NRf>

Example:

FETC:CURR:HARM? 5

**FETCh[:SCALar]:VOLTage:HARMonic:DISTort? <NR1>**

**MEASure[:SCALar]:VOLTage:HARMonic:DISTort?  
<NR1>**

This command is used to measure voltage harmonic components.

Syntax:

FETCh[:SCALar]:VOLTage:HARMonic:DISTort? <NR1>

MEASure[:SCALar]:VOLTage:HARMonic:DISTort? <NR1>

Arguments:

NR1: 0-50

Returns:

<NRf>

Example:

FETC:VOLT:HARM:DIST? 8

## **FETCh[:SCALar]:CURRent:HARMonic:DISort? <NR1>**

### **MEASure[:SCALar]:CURRent:HARMonic:DISort? <NR1>**

This command is used to measure the harmonic components of the current.

#### Syntax:

FETCh[:SCALar]:CURRent:HARMonic:DISort? <NR1>

#### Arguments:

NR1: 0-50

#### Returns:

<NRf>

#### Example:

FETC:CURR:HARM:DIS? 10

## **FETCh[:SCALar]:VOLTage:HARMonic:PHASe? <NR1>**

### **MEASure[:SCALar]:VOLTage:HARMonic:PHASe? <NR1>**

This command is used to measure the phase of voltage harmonics.

#### Syntax:

FETCh[:SCALar]:VOLTage:HARMonic:PHASe? <NR1>

MEASure[:SCALar]:VOLTage:HARMonic:PHASe? <NR1>

#### Arguments:

NR1: 0-50

#### Returns:

<NRf>

#### Example:

FETC:VOLT:HARM:PHAS? 5

## **FETCh[:SCALar]:CURRent:HARMonic:PHASe? <NR1>**

### **MEASure[:SCALar]:CURRent:HARMonic:PHASe? <NR1>**

This command is used to measure the phase of current harmonics.

**Syntax:**

```
FETCh[:SCALar]:CURRent:HARMonic:PHASe? <NR1>  
MEASure[:SCALar]:CURRent:HARMonic:PHASe? <NR1>
```

**Arguments:**

NR1: 0-50

**Returns:**

<NRf>

**Example:**

```
FETC:CURR:HARM:PHAS? 10
```

## **FETCh[:SCALar]:VOLTage:HARMonic:THD?**

## **MEASure[:SCALar]:VOLTage:HARMonic:THD?**

This command is used to measure the total harmonic distortion of voltage.

**Syntax:**

```
FETCh[:SCALar]:VOLTage:HARMonic:THD?  
MEASure[:SCALar]:VOLTage:HARMonic:THD?
```

**Returns:**

<NRf>

**Example:**

```
FETC:VOLT:HARM:THD?
```

## **FETCh[:SCALar]:CURRent:HARMonic:THD?**

## **MEASure[:SCALar]:CURRent:HARMonic:THD?**

This command is used to measure the total harmonic distortion of the current.

**Syntax:**

```
FETCh[:SCALar]:CURRent:HARMonic:THD?  
MEASure[:SCALar]:CURRent:HARMonic:THD?
```

**Returns:**

<NRf>

**Example:**

```
FETC:CURR:HARM:THD? A
```

## **FETCh[:SCALar]:ARRay:VOLTage:HARMonic[:AMPLitude]? <NR1>**

## **MEASure[:SCALar]:ARRay:VOLTage:HARMonic[:AMPLitude]? <NR1>**

This command measures the amplitude of voltage harmonics. The NR1 parameter ranges from 0 to 50, where 0 represents the DC component, 1 represents the fundamental wave, and 2 to 50 represent harmonic components. For example, setting NR1 to 10 will list the amplitude values of voltage harmonics from 0 to 10.

### Syntax:

FETCh[:SCALar]:ARRay:VOLTage:HARMonic[:AMPLitude]? <NR1>

### Arguments:

NR1: 0-50

### Returns:

<NRf>

### Example:

FETC:ARR:VOLT:HARM? 11

## **FETCh[:SCALar]:ARRay:CURRent:HARMonic[:AMPLitude]? <NR1>**

## **MEASure[:SCALar]:ARRay:CURRent:HARMonic[:AMPLitude]? <NR1>**

This command is used to measure the amplitude of each harmonic component of the current.

### Syntax:

FETCh[:SCALar]:ARRay:CURRent:HARMonic[:AMPLitude]? <NR1>

MEASure[:SCALar]:ARRay:CURRent:HARMonic[:AMPLitude]? <NR1>

### Arguments:

NR1: 0-50

### Returns:

<NRf>

### Example:

FETC:ARR:CURR:HARM? A,6

## **FETCh[:SCALar]:ARRay:VOLTage:HARMonic:PHASe? <NR1>**

## **MEASure[:SCALar]:ARRay:VOLTage:HARMonic:PHASe? <NR1>**

This command is used to measure the phase of each harmonic component of the voltage.

### Syntax:

FETCh[:SCALar]:ARRay:VOLTage:HARMonic:PHASe? <NR1>  
MEASure[:SCALar]:ARRay:VOLTage:HARMonic:PHASe? <NR1>

### Arguments:

NR1: 0-50

### Returns:

<NRf>

### Example:

FETC:ARR:VOLT:HARM:PHAS? 6

## **FETCh[:SCALar]:ARRay:CURREnt:HARMonic:PHASe? <NR1>**

## **MEASure[:SCALar]:ARRay:CURREnt:HARMonic:PHASe? <NR1>**

This command is used to measure the phase of each harmonic component of the current.

### Syntax:

FETCh[:SCALar]:ARRay:CURREnt:HARMonic:PHASe? <NR1>  
MEASure[:SCALar]:ARRay:CURREnt:HARMonic:PHASe? <NR1>

### Arguments:

NR1: 0-50

### Returns:

<NRf>

### Example:

FETC:ARR:CURR:HARM:PHAS? 4

## **FETCh[:SCALar]:ARRay:VOLTage:HARMonic:DISTort? <NR1>**

## **MEASure[:SCALar]:ARRay:VOLTage:HARMonic:DISTort? <NR1>**

This command is used to measure the voltage harmonic distortion.

### Syntax:

FETCh[:SCALar]:ARRay:VOLTage:HARMonic:DISTort? <NR1>

MEASure[:SCALar]:ARRay:VOLTage:HARMonic:DISTort? <NR1>

### Arguments:

NR1: 0-50

### Returns:

<NRf>

### Example:

FETC:ARR:VOLT:HARM:DIST? 6

## **FETCh[:SCALar]:ARRay:CURREnt:HARMonic:DISTort? <NR1>**

## **MEASure[:SCALar]:ARRay:CURREnt:HARMonic:DISTort? <NR1>**

This command is used to measure the harmonic distortion of the current.

### Syntax:

FETCh[:SCALar]:ARRay:CURREnt:HARMonic:DISTort? <NR1>

MEASure[:SCALar]:ARRay:CURREnt:HARMonic:DISTort? <NR1>

### Arguments:

NR1: 0-50

### Returns:

<NRf>

### Example:

FETC:ARR:CURR:HARM:DIST? 6

## **FETCh[:SCALar]:WHOUr[:ACTive][:SUM]?**

This command is used to read the sum of the most recent positive and negative

watt-hours.

Syntax:

FETCh[:SCALar]:WHOur[:ACTive][:SUM]?

Returns:

<NRf>

Example:

FETCh:WHOur?

## **FETCh[:SCALar]:WHOur[:ACTive]:POSitive?**

This command is used to read the most recently consumed positive watt-hours.

Syntax:

FETCh[:SCALar]:WHOur[:ACTive]:POSitive?

Returns:

<NRf>

Example:

FETCh:WHOur:POSitive?

## **FETCh[:SCALar]:WHOur[:ACTive]:NEGative?**

This command is used to read the negative watt-hours of the most recent feedback power supply.

Syntax:

FETCh[:SCALar]:WHOur[:ACTive]:NEGative?

Returns:

<NRf>

Example:

FETCh:WHOur:NEGative?

## **FETCh[:SCALar]:AHOuR[:ACTive][:SUM]?**

This command is used to read the sum of the most recent positive and negative ampere-hours.

Syntax:

FETCh[:SCALar]:AHOuR[:ACTive][:SUM]?

Returns:

<NRf>

Example:

FETCh:AHOur?

## **FETCh[:SCALar]:AHOur[:ACTive][:SUM]?**

This command is used to read the sum of the most recent positive and negative ampere-hours.

Syntax:

FETCh[:SCALar]:AHOur[:ACTive][:SUM]?

Returns:

<NRf>

Example:

FETCh:AHOur?

## **FETCh[:SCALar]:AHOur[:ACTive]:POSitive?**

This command is used to read the most recent positive time.

Syntax:

FETCh[:SCALar]:AHOur[:ACTive]:POSitive?

Returns:

<NRf>

Example:

FETCh:AHOur:POSitive?

## **FETCh[:SCALar]:AHOur[:ACTive]:NEGative?**

This command is used to read the most recent negative ampere-hour reading.

Syntax:

FETCh[:SCALar]:AHOur[:ACTive]:NEGative?

Returns:

<NRf>

Example:

FETCh:AHOur:NEGative?

## **FETCh[:SCALar]:ENERgy:TIME?**

This command is used to read the most recent integration time.

Syntax:

FETCh[:SCALar]:ENERgy:TIME?

Returns:

<NRf>

Example:

FETCh:ENERgy:TIME?

---

## Chapter25 Current List Subsystem

---

### **LIST:STATe?**

This command is used to query the operational status of the list: IDLE: Stopped  
WTG: Waiting for trigger ACTIVE: Running

#### Syntax

LIST:STATe?

#### Example

LIST:STAT?

### **LIST:REPeat <NR1>**

This command is used to set and query the number of iterations for the list operation.

#### Syntax

LIST:REPeat <NR1>

#### Arguments:

<NR1>  
MINimum|MAXimum|DEFault

#### \*RST

0

#### Query syntax

LIST:REPeat?

#### Returns

<NR1>

#### Example

LIST:REP 10

### **LIST:TERMinate <CPD>**

This command is used to set and query the way to end the list operation. There are three ways to end:

NORMAL: after the list runs, it will automatically return to normal.

LAST: keep the output of the last step after the list runs.

OFF: turn off the output after the list operation is over and still in the list mode.

#### Syntax

LIST:TERMinate <CPD>

## Arguments

<CPD>  
 NORMal|LAST|OFF

## Query syntax

LIST:TERMinate?

## Returns

NORMal|LAST|OFF

## \*RST

OFF

## Example

LIST:TERM LAST

## LIST:RUNTime:STAtE?

This command is used to query the runtime information of List, in which loop the list is presently running, and at which step it is presently running.

Return value: <NR1>,<NR1> The first is the number of cycles presently running, and the second is the position of the present running step.

## Syntax

LIST:RUNTime:STAtE?

## Returns

<NR1>,<NR1>

## Example

LIST:RUNTime:STAtE?

## [ARB:]LIST:RCL <string>

This command is used to call back the saved list file and query the file name presently called.

## Syntax

[ARB:]LIST:RCL <string>

## Query syntax

[ARB:]LIST:RCL?

## Example

LIST:RCL test.csv

## [ARB:]LIST:STEP:COUnT <NR1>

This command is used to set and query the total number of steps in the list.

## Syntax

[ARB:]LIST:STEP:COUNT <NR1>

## Argument

<NR1>|MINimum|MAXimum|DEFault

## Query syntax

[ARB:]LIST:STEP:COUNT?

## Returns

<NR1>

## \*RST

10

## Example

LIST:STEP:COUN 10

## [ARB:]LIST:CLEAr

This command is used to clear the list configuration.

## Syntax

[ARB:]LIST:CLEAr

## Example

LIST:CLE

## LIST:STEP <NR1>,<string>

This command is used to configure and query list step arguments.

<NR1>: Step Index, valid range [-1, 1-100]. -1 inserts the Arguments step to the end of the list; other values insert it at the specified step index.

<string>: Arguments are separated by commas, in the following order:

3-Phase:

IAC_A	0
IAC_B	1
IAC_C	2
IAC_SLEW_A	3
IAC_SLEW_B	4
IAC_SLEW_C	5
IDC_A	6
IDC_B	7
IDC_C	8
IDC_SLEW_A	9

IDC_SLEW_B	10
IDC_SLEW_C	11
PHASE_MODE	12
START_A	13
START_B	14
START_C	15
R_A	16
R_B	17
R_C	18
R_A_SLEW	19
R_B_SLEW	20
R_C_SLEW	21
THREE_WAVE_A	22
THREE_WAVE_B	23
THREE_WAVE_C	24
THREE_TIME_MODE	25
THREE_TIME	26
THREE_TRIG_OUT	27
A_PHASE_SHIFT	29
B_PHASE_SHIFT	29
C_PHASE_SHIFT	30
A_wave_PARAM	31
B_WAVE_PARAM	32
C_WAVE_PARAM	33
1-phase:	
IAC	0
IAC_SLEW	1
IDC	2
IDC_SLEW	3
PHASE_MODE	4
START_A	5
R	6
R_SLEW	7
WAVE	9
TIME_MODE	9
TIME	10
TRIG_OUT	11
PHASE_START	12
WAVE_PARM	13

## Syntax

LIST:STEP <NR1>,<string>

## Query syntax

LIST:STEP? <NR1>

## Example

Step Arguments for inserting into the end of a list in three-phase mode:

list:step -1,"9.2,100,21,20,PHASe,359.9,100,100,Sine,TRIG,phase,123,ON"

Note: When operating in AC mode, the DC amplitude (red Arguments section) must be set to 0.0. Failure to do so will result in an Arguments overflow error.

## LIST:STEP:ITEM <NR1>,<NR1>,<string>

This command is used to configure and query the phase parameters for a specific step in the list.

Below are all parameter ID for three-phase mode. Those marked "single-phase" indicate they can be used to set and query corresponding parameter values in single-phase mode. no three-phase mode is available for current sources. To maintain maximum compatibility, the parameter structure for this command still adopts the three-phase parameter mode. When using this command, only set the relevant parameters marked "single-phase."

A-lac ID:	0 (1-phase)
B-lac ID:	1
C-lac ID:	2
A-lac slope ID:	3 (1-phase)
B-lac slope ID:	4
C-lac slope ID:	5
A-lac ID:	6 (1-phase)
B-lac ID:	7
C-lac ID:	8
A-lac slope ID:	9 (1-phase)
B-lac slope ID:	10
C-lac slope ID:	11
Phase mode ID:	12 (1-phase)(PHASe CONTInues)
A-start angle ID:	13 (1-phase)
B-start angle ID:	14(Retain)
C-start angle ID:	15(Retain)
A-frequency ID:	16 (1-phase)
B-frequency ID:	17(Retain)
C-frequency ID:	18(Retain)
A-frequency slope ID:	19 (1-phase)
B-frequency slope ID:	20(Retain)

C-frequency slope ID: 21(Retain)  
 A-waveform type ID: 22 (1-phase)  
 B-waveform type ID: 23  
 C-waveform type ID: 24  
 Step jump 1 ID: 25 (single-phase)(TIME|TRIGger|PHASe)  
 Step jump 2 ID: 26 (single-phase)( When Step jump 1 ID is TIME, this parameter is the time value; when Step jump 1 ID is TRIGger, this parameter can be IMME/PHASe; when Step jump 1 ID is PHASe, this parameter is the angle value)  
 Trigger Pulse ID: 27 (single-phase)(OFF|ON)  
 BA angle ID 28  
 BA angle slope ID 29  
 CA angle ID 30  
 CA angle slope ID 31  
 Step jump 3 ID 32 (single-phase)( This parameter is meaningful only when jump Step jump 1 ID is TRIGger and Step jump 2 ID is PHASe, which is the angle value)  
 <string>: This parameter is the corresponding parameter value for the ID specified by NR2.

### Syntax

LIST:STEP:ITEM <NR1>,<NR2>,<string>

### Query syntax

LIST:STEP:ITEM? <NR1>,<item>

### Example

LIST:STEP:ITEM 1,0,"100"  
 LIST:STEP:ITEM 1,22,"Sine"

## LIST:STEP:ITEM? <NR1>,<item>

This command is used to query the phase parameters of a certain step in the list.

### Syntax

LIST:STEP:ITEM? <NR1>,<item>

### Arguments:

<NR1>,<item>

### Returns:

<NRf+>

### Example

LIST:STEP:ITEM? 1,6

## **[ARB:]LIST:NAME?**

This command is used to query the path name of the presently opened list file.

### Syntax

```
[ARB:]LIST:NAME?
```

### Example

```
LIST:NAME?
```

## **[ARB:]LIST:SAVe <filename>**

This command is used to save the file to the /mnt/emm\_user/user\_data/sys/list/ directory. If the file name already exists, the present file will be overwritten, if it does not exist, it will be saved as a new file.

### Syntax

```
[ARB:]LIST:SAVe <filename>
```

### Example

```
LIST:SAVe "123"
```

## **[ARB:]LIST:CONFigure**

This command is used to make the presently configured list parameters take effect.

### Syntax

```
[ARB:]LIST:CONFigure
```

### Example

```
LIST:CONF
```

## **[ARB:]LIST:CREate**

This command is used to create a list.

### Syntax

```
[ARB:]LIST:CREate
```

### Example

```
LIST:CRE
```

## **[ARB:]LIST:FILE:NUMBer?**

This command is used to query the number of list files under the present device type.

### Syntax

```
[ARB:]LIST:FILE:NUMBer?
```

## Example

```
LIST:FILE:NUMB?
```

**[ARB:]LIST:FILE:NAME? <index>**

This command is used to query the name of a list file according to the index.

## Syntax

```
[ARB:]LIST:FILE:NAME? <index>
```

## Argument:

```
<NR1>
```

## Example

```
LIST:FILE:NAME? 1
```

**[ARB:]LIST:FILE:DELeTe <filename>**

This command is used to delete the list file.

## Syntax

```
[ARB:]LIST:FILE:DELeTe <filename>
```

## Argument

```
<CPD>
```

## Example

```
LIST:FILE:DEL "123"
```

**[ARB:]LIST:STEP:DELeTe <NR1>**

This command is used to delete the list step.

## Syntax

```
[ARB:]LIST:STEP:DELeTe <NR1>
```

## Argument

```
<NR1>
```

## Example

```
LIST:STEP:DELeTe 1 //delete the step1
```

**[ARB:]LIST:STEP:EDIT <NR1>,<string>**

This command is used to edit the list step parameter.

Note: This command only modifies the parameters of the currently existing steps, and does not add new steps.

## Syntax

```
[ARB:]LIST:STEP:EDIT <NR1>,<string>
```

## Argument

<NR1>: step number

<string>: step parameters

## Example

```
list:step:edit
1,"10,10,10,100,100,100,0.5,0.5,0.5,20,20,20,PHASe,356.9,30,100,40,120,100,1
01,Sine,Sine,Sine,TRIG,PHASE,55,OFF" //edit the step parameters for three
phase
list:step:edit 1,"9.2,100,21,20,PHASe,359.9,100,100,Sine,TRIG,phase,123,ON"
//edit the step parameters for single phase
```

## **LIST:STEP:DELeTe <NR1>**

This command is used to remove the list step by step.

## Syntax

```
LIST:STEP:DELeTe <NR1>
```

## Arguments

<NR1>

## Example

```
LIST:STEP:DEL 2
```

## **LIST:STEP:JUMP <NR1>**

This command is used to set the step number for loop skipping. For example, setting it to 2 causes subsequent loops to skip the first two steps and begin execution from step 3.

NR1: The minimum value is 0, meaning no steps are skipped and all steps are cycled through; the maximum value is less than the total number of steps.

## Syntax

```
LIST:STEP:JUMP <NR1>
```

## Arguments:

<NR1>

## Query syntax:

```
LIST:STEP:JUMP? [MAXimum|MINimum]
```

## Returns:

<NRf+>

## Example

```
LIST:STEP:JUMP 2
```

**LIST:TRAPezoid:PARAm <NR1>,<CPD>,<NRf+>**

Set or query the TRAPezoid waveform parameters for a specific step and phase in the LIST. This is effective when the waveform is selected as Trapezoid.

DEF = 0.1

## Syntax

```
LIST:TRAPezoid:PARAm <NR1>,<CPD>,<NRf+>
```

## Arguments:

NR1: Current list step number (1-total steps)

CPD: Specify which phase (A|B|C)

NRf+: value

## Query syntax:

```
LIST:TRAPezoid:PARAm? <NR1>,<CPD>,[MAXimum|MINimum|DEFault]
```

## Returns:

<NRf+>

## Example

```
LIST:CLIP:PAR 2,A,0.2
```

```
LIST:CLIP:PAR? 2,A
```

**LIST:CLIPped:PARAm <NR1>,<CPD>,<NRf+>**

Set or query the Clipped waveform parameters for a specific step and phase in the LIST.

DEF = 0.1;

## Syntax

```
LIST:CLIPped:PARAm <NR1>,<CPD>,<NRf+>
```

## Arguments:

NR1: Current list step number (1-total steps)

CPD: Specify which phase (A|B|C)

NRf+: value

## Query syntax:

```
LIST:CLIPped:PARAm? <NR1>,<CPD>,[MAXimum|MINimum|DEFault]
```

## Returns:

<NRf+>

## Example

```
LIST:CLIP:PAR 2,A,0.2
```

```
LIST:CLIP:PAR? 2,A
```

## **LIST:RECTifier:PARam <NR1>,<CPD>,<NRf+>**

Set or query the TRAPezoid waveform parameters for a specific step and phase in the LIST.

```
DEF = 45.0
```

## Syntax

```
LIST:RECTifier:PARam <NR1>,<CPD>,<NRf+>
```

## Arguments:

NR1: Current list step number (1-total steps)

CPD: Specify which phase (A|B|C)

NRf+: value

## Query syntax:

```
LIST:RECTifier:PARam? <NR1>,<CPD>,[MAXimum|MINimum|DEFault]
```

## Returns:

```
<NRf+>
```

## Example

```
LIST:RECT:PAR 2,A,50.0
```

```
LIST:RECT:PAR? 2,A
```

## Chapter26 Current WAVEform Subsystem

### WAVEform[:IMMEDIATE] <WAVEform>

Set and query waveforms in Normal mode. For waveforms with parameters, set the parameters to their default values.

<wave>:

- Sine
- Square
- Saw
- Triangle
- Trapezoid
- Clipped-sine
- DST-01(30)
- Filename

#### Syntax

WAVEform[:IMMEDIATE] <WAVEform>

#### Arguments

<"Sine"|"Square"|"Triangle"|"Saw"|"Trapezoid"|"Clipped-sine"|"DST-01(30)"|"filename">,

<"Sine"|"Square"|"Triangle"|"Saw"|"Trapezoid"|"Clipped-sine"|"DST-01(30)"|"filename">,

<"Sine"|"Square"|"Triangle"|"Saw"|"Trapezoid"|"Clipped-sine"|"DST-01(30)"|"filename">,

#### \*RST

Sine

#### Query syntax

WAVEform?

#### Returns

<string>

#### Example

WAVE "Sine"

WAVE?

### WAVEform[:IMMEDIATE] <phase/chan>,<WAVEform>

Set and query waveforms for a specific phase/channel in Normal mode. For parameterized waveforms, parameters are set to default values.

<phase/chan> Phase index value or channel index value.

<wave> Waveform index value. Index values are as follows.

- Sine
- Square
- Saw
- Triangle
- Trapezoid
- Clipped-sine
- DST-01(30)
- Filename

### Syntax

PWAVEform[:IMMediate] <WAVEform>

### Arguments

<"Sine"|"Square"|"Triangle"|"Saw"|"Trapezoid"|"Clipped-sine"|"DST-01(30)"|"filename">

### \*RST

Sine

### Query syntax

PWAVEform?

### Returns

<string>

### Example

PWAVE " Sine"

PWAVE?

## **WAVEform:EDIT:PARAmeter <phase/chan>,<percent1>**

Set and query waveform parameters for a specific phase/channel (e.g., clipping percentage; this parameter is invalid for waveform types without parameters).

### Syntax

WAVEform:EDIT:PARAmeter <percent1>

### Arguments

<0-0.5>|<0-0.25>

### Query syntax

WAVEform:EDIT:PARAmeter?

### Returns

<NRF>

## Example

```
WAVe:EDIT:PAR 0.25
WAVe:EDIT:PAR?
```

## WAVeform:EDIT:THD:CLEAr

Clear the THD wave edit memory data.

## Syntax

```
WAVeform:EDIT:THD:CLEAr
```

## Example

```
WAVe:EDIT:THD:CLE
```

## WAVeform:EDIT:THD:IMPorT <filename>

This command imports an existing THD waveform file into the edit memory and retrieves the filename of the currently imported THD waveform file from external storage.

## Syntax

```
WAVeform:EDIT:THD:IMPorT <filename>
```

## Arguments

```
"filename"
```

## Query syntax

```
WAVeform:EDIT:THD:IMPorT?
```

## Returns

```
<string>
```

## Example

```
WAVe:EDIT:THD:IMP "Thd01.csv"
WAVe:EDIT:THD:IMP?
```

## WAVeform:EDIT:THD:FORMula <formula>

This command is used to set and query the calculation method for the distortion factor of the edited THD wave.

## Syntax

```
WAVeform:EDIT:THD:FORMula <formula>
```

## Arguments

```
<%F|%R>
```

## Query syntax

```
WAVeform:EDIT:THD:FORMula?
```

## Returns

<CPD>

## Example

WAVe:EDIT:THD:FORM %F

WAVe:EDIT:THD:FORM?

## **WAVeform:EDIT:THD:FUNDamental:PHASe <phase>**

Set and query the initial phase of the fundamental waveform in THD.

## Syntax

WAVeform:EDIT:THD:FUNDamental:PHASe <phase>

## Arguments

MAXimum|MINimum|DEFault

## Query syntax

WAVeform:EDIT:THD:FUNDamental:PHASe? [MAXimum|MINimum|DEFault]

## Returns

MAXimum|MINimum|DEFault

## Example

WAV:EDIT:THD:FUND:PHAS 30

WAV:EDIT:THD:FUND:PHAS?

## **WAVeform:EDIT:THD:DATA <order>,<string>**

Set and query the THD value and phase parameters for a specific harmonic

## Syntax

WAVeform:EDIT:THD:DATA <order>,<string>

## Arguments

<2-50>,<"thd,phase">

## Query syntax

WAVeform:EDIT:THD:DATA? <order>

## Returns

<string>

## Example

WAVe:EDIT:THD:DATA 2, "9.8,0.0"

WAVe:EDIT:THD:DATA? 2

**WAVEform:EDIT:THD:SAVE:LOCal <filename>**

This command saves the currently edited THD waveform data to a local file and specifies the filename (if the filename is the same, it is treated as modifying the current waveform; if the filename does not exist, it is treated as creating a new file).

## Syntax

WAVEform:EDIT:THD:SAVE:LOCal <filename>

## Arguments

"filename"

## Example

WAVE:EDIT:THD:SAVE:LOC "THD01.csv"

**WAVEform:EDIT:THD:SAVE:UDISk <filename>**

This command saves the currently edited THD waveform data to a USB drive file and specifies the filename (if the filename matches an existing file, it modifies the current waveform; if the filename does not exist, it creates a new file).

## Syntax

WAVEform:EDIT:THD:SAVE:UDISk <filename>

## Arguments

"filename"

## Example

WAVE:EDIT:THD:SAVE:UDIS "THD01.csv"

**WAVEform:EDIT:THD:DELeTe <filename>**

This command is used to delete locally customized THD waveform files from the system.

## Syntax

WAVEform:EDIT:THD:DELeTe <filename>

## Arguments

"filename"

## Example

WAV:EDIT:THD:DEL "THD01.csv"

**WAVEform:EDIT:USERdefine:CLEAr**

This command is used to clear user-defined waveform editing memory data.

## Syntax

WAVEform:EDIT:USERdefine:CLEAr

## Example

```
WAVe:EDIT:USER:CLE
```

## WAVEform:EDIT:USERdefine:IMPport <filename>

This command imports existing custom wave data into the editor's memory and retrieves the filename of the imported custom wave.

## Syntax

```
WAVEform:EDIT:USERdefine:IMPport <filename>
```

## Arguments

"filename"

## Query syntax

```
WAVEform:EDIT:USERdefine:IMPport?
```

## Returns

<string>

## Example

```
WAVe:EDIT:USER:IMP "USER01"  
WAVe:EDIT:USER:IMP?
```

## WAVEform:EDIT:USERdefine:MODE <symmetry>

This command is used to set and query custom wave editing modes, where:

ASYM: Users can only edit the first 512 points, not symmetrical about the origin;

SYMM: Users can only edit the first 512 points, symmetrical about the origin;

FULL: Users can freely edit all 1024 points across the entire cycle.

## Syntax

```
WAVEform:EDIT:USERdefine:MODE <symmetry>
```

## Arguments

<ASYM,SYMM,FULL>

## Query syntax

```
WAVEform:EDIT:USERdefine:MODE?
```

## Returns

<ASYM,SYMM,FULL>

## Example

```
WAVe:EDIT:USER:MODE ASYM  
WAVe:EDIT:USER:MODE?
```

**WAVEform:EDIT:USERdefine:DATA <index>,<normalization>**

Set and query the normalized point value at the index point.

## Syntax

WAVEform:EDIT:USERdefine:DATA <index>,<normalization>

## Arguments

<0-1023>,<0.0-1.0> (Note: The index range varies depending on the currently set waveform editing mode (symmetry property). FULL mode uses 0-1023, while other modes use 0-511.)

## Query syntax

WAVEform:EDIT:USERdefine:DATA? <index>

## Returns

<NR2>

## Example

WAVE:EDIT:USER:DATA 1,0.5

WAVE:EDIT:USER:DATA? 1

**WAVEform:EDIT:USERdefine:SAVE:LOCAL <filename>**

This command saves the currently edited custom waveform data to a file and specifies the filename. If the filename is the same, it is treated as modifying the current waveform; if the filename does not exist, it is treated as creating a new file.

## Syntax

WAVEform:EDIT:USERdefine:SAVE:LOCAL <filename>

## Arguments

"filename"

## Example

WAVE:EDIT:USER:SAVE:LOC "USER01.csv"

**WAVEform:EDIT:USERdefine:SAVE:UDISK <filename>**

This command saves the currently edited custom waveform data to a USB drive file and specifies the filename (if the filename is identical, it modifies the current waveform; if the filename does not exist, it creates a new file).

## Syntax

WAVEform:EDIT:USERdefine:SAVE:UDISK <filename>

## Arguments

"filename"

## Example

```
WAVe:EDIT:USER:SAVE:UDIS "USER01.csv"
```

## **WAVEform:EDIT:USERdefine:DELeTe <filename>**

This command is used to delete locally customized waveform files from the system.

## Syntax

```
WAVEform:EDIT:USERdefine:DELeTe <filename>
```

## Example

```
WAV:EDIT:USER:DEL "USER01.csv"
```

## **WAVEform:EDIT:THD:FILE:NUMBer?**

This command is used to retrieve the number of THD custom waveform files stored locally on the device (file\_number).

## Syntax

```
WAVEform:EDIT:THD:FILE:NUMBer?
```

## Example

```
WAV:EDIT:THD:FILE:NUMB?
```

## **WAVEform:EDIT:THD:FILE:NAME? <index>**

Look up the name of a custom THD waveform file stored locally on the device using an index;

Note: Index values start at 0.

## Syntax

```
WAVEform:EDIT:THD:FILE:NAME? <index>
```

## Arguments

0 - (file\_number-1)|MAXimum|MINimum

## Returns

<NR1>

## Example

```
WAV:EDIT:THD:FILE:NAME? 2
```

## **WAVEform:EDIT:USERdefine:FILE:NUMBer?**

Retrieve the number of user-defined waveform files stored locally on the device (file\_number).

## Syntax

```
WAVEform:EDIT:USERdefine:FILE:NUMBer?
```

## Example

WAV:EDIT:USER:FILE:NUMB?

## WAVEform:EDIT:USERdefine:FILE:NAME? <index>

Look up the name of a user-defined waveform file stored locally on the device using an index;

Note: Index values start at 0.

## Syntax

WAVEform:EDIT:USERdefine:FILE:NAME? <index>

## Arguments

0 - (file\_number-1)|MAXimum|MINimum

## Returns

<NR1>

## Example

WAV:EDIT:USER:FILE:NAME? 2

---

## Chapter27 Channel Subsystem (Load)

---

### CHANnel[:SElect] <CPD>

This command is used to select A B C phase.

#### Syntax:

```
CHANnel[:SElect] <CPD>
```

#### Arguments

```
<A|B|C>
```

#### Returns:

```
IDLE|AC|ISLAnd|RLC
```

#### Example

```
CHANnel A //Select A phase
```

#### Query syntax:

```
CHANnel[:SElect]?
```

## Chapter28 FETCh & MEASure Subsystem (Load)

---

### FETCh[:SCALar]:CURRent[:AC]?

### MEASure[:SCALar]:CURRent[:AC]?

This command is used to read the RMS value of current.

Note: this command parameter is optional. If there is no parameter, it will return the value of A, B, C three-phase by default.

#### Syntax:

```
FETCh[:SCALar]:CURRent? [A|B|C]
```

```
MEASure[:SCALar]:CURRent[:AC]? [A|B|C]
```

#### Arguments

[A|B|C]

#### Returns:

<NRf>...

#### Example

```
FETC:CURR? A
```

```
MEAS:CURR?
```

### FETCh[:SCALar]:CURRent:DC?

### MEASure[:SCALar]:CURRent:DC?

This command is used to read the DC component of current.

Note: this command parameter is optional. If there is no parameter, it will return the value of A, B, C three-phase by default.

#### Syntax:

```
FETCh[:SCALar]:CURRent? [A|B|C]
```

```
MEASure[:SCALar]:CURRent:DC? [A|B|C]
```

#### Arguments

[A|B|C]

#### Returns:

<NRf>...

## Example

```
FETC:CURR:DC?  
MEAS:CURR:DC?
```

## **FETCh[:SCALar]:CURRent[:AC][:AMPLitude]:MAXimum:POSitive?**

## **MEASure[:SCALar]:CURRent[:AC][:AMPLitude]:MAXimum:POSitive?**

This command is used to read the positive peak value of current.

Note: this command parameter is optional. If there is no parameter, it will return the value of A, B, C three-phase by default.

## Syntax:

```
FETCh[:SCALar]:CURRent[:AC][:AMPLitude]:MAXimum:POSitive?  
MEASure[:SCALar]:CURRent[:AC][:AMPLitude]:MAXimum:POSitive?
```

## Arguments

[A|B|C]

## Returns:

<NRf>...

## Example

```
FETC:CURR:MAX:POS?  
MEAS:CURR:MAX:POS? A
```

## **FETCh[:SCALar]:CURRent[:AC][:AMPLitude]:MAXimum:NEGative?**

## **MEASure[:SCALar]:CURRent[:AC][:AMPLitude]:MAXimum:NEGative?**

This command is used to read the negative peak value of current.

Note: this command parameter is optional. If there is no parameter, it will return the value of A, B, C three-phase by default.

## Syntax:

```
FETCh[:SCALar]:CURRent[:AC][:AMPLitude]:MAXimum:NEGative? [A|B|C]  
MEASure[:SCALar]: CURRent[:AC][:AMPLitude]:MAXimum:NEGative? [A|B|C]
```

## Arguments

[A|B|C]

## Returns:

<NRf>...

## Example

```
FETC:CURR:MAX:NEG?
```

**FETCh[:SCALar]:CURRent[:AC][:AMPLitude]:MAXimum?****MEASure[:SCALar]:CURRent[:AC][:AMPLitude]:MAXimum?**

This command is used to read the peak value of current.

Note: this command parameter is optional. If there is no parameter, it will return the value of A, B, C three-phase by default.

## Syntax:

FETCh[:SCALar]:CURRent[:AC][:AMPLitude]:MAXimum?

MEASure[:SCALar]:CURRent[:AC][:AMPLitude]:MAXimum?

## Arguments

[A|B|C]

## Returns:

<NRf>...

## Example

FETC:CURR:MAX?

**FETCh[:SCALar]:VOLTage[:AC][:AMPLitude]:MAXimum:HOLD?****MEASure[:SCALar]:VOLTage[:AC][:AMPLitude]:MAXimum:HOLD?**

This command is used to read the peak voltage hold value of ABC. It will be cleared automatically on the next power-on.

Note: this command parameter is optional. If there is no parameter, it will return the value of A, B, C three-phase by default.

## Syntax:

FETCh[:SCALar]:VOLTage[:AC][:AMPLitude]:MAXimum:HOLD?

MEASure[:SCALar]:VOLTage[:AC][:AMPLitude]:MAXimum:HOLD?

## Arguments

[A|B|C]

## Returns:

<NRf>...

## Example

FETC:CURR:CFAC?

**FETCh[:SCALar]:VOLTage[:AC][:AMPLitude]:MAXimum:HOLD:CLEar****MEASure[:SCALar]:VOLTage[:AC][:AMPLitude]:MAXimum:HOLD:CLEar**

This command is used to clear the single-phase voltage peak hold value.

Note: this command parameter is optional. If there is no parameter, it will return the value of A, B, C three-phase by default.

#### Syntax:

```
FETCh[:SCALar]:VOLTage[:AC][:AMPLitude]:MAXimum:HOLD:CLEar
MEASure[:SCALar]:VOLTage[:AC][:AMPLitude]:MAXimum:HOLD:CLEar
```

#### Arguments

[A|B|C]

#### Returns:

<NRf>...

#### Example

```
FETCh:VOLTage:MAXimum:HOLD:CLEar
```

## FETCh[:SCALar]:CURRent:CFACtor?

## MEASure[:SCALar]:CURRent:CFACtor?

This command is used to read the current crest factor values of A, B, C three-phase.

Note: this command parameter is optional. If there is no parameter, it will return the value of A, B, C three-phase by default.

#### Syntax:

```
FETCh[:SCALar]:CURRent:CFACtor? [A|B|C]
MEASure[:SCALar]:CURRent:CFACtor? [A|B|C]
```

#### Arguments

[A|B|C|CH1|CH2|CH3]

#### Returns:

<NRf>...

#### Example

```
FETC:CURR:CFAC?
```

## FETCh[:SCALar]:FREQUency?

## MEASure[:SCALar]:FREQUency?

This command is used to read the frequency value.

Note: this command parameter is optional. If there is no parameter, it will return the value of A, B, C three-phase by default.

**Syntax:**

```
FETCh[:SCALar]:FREQuency? [A|B|C]
MEASure[:SCALar]:FREQuency? [A|B|C]
```

**Arguments**

```
[A|B|C]
```

**Returns:**

```
<NRf>...
```

**Example**

```
FETC:FREQ?
```

## **FETCh[:SCALar]:POWer[:REAL]?**

## **MEASure[:SCALar]:POWer[:REAL]?**

This command is used to read the real power value.

Note: this command parameter is optional. If there is no parameter, it will return the value of A, B, C three-phase by default.

**Syntax:**

```
FETCh[:SCALar]:POWer [:REAL]? [A|B|C]
MEASure[:SCALar]:POWer[:REAL]? [A|B|C]
```

**Arguments**

```
[A|B|C]
```

**Returns:**

```
<NRf>...
```

**Example**

```
FETC:POWer?
```

## **FETCh[:SCALar]:POWer:APParent?**

## **MEASure[:SCALar]:POWer:APParent?**

This command is used to read the apparent power value.

Note: this command parameter is optional. If there is no parameter, it will return the value of A, B, C three-phase by default.

**Syntax:**

```
FETCh[:SCALar]:POWer:APParent? [A|B|C]
MEASure[:SCALar]:POWer:APParent? [A|B|C]
```

## Arguments

[A|B|C]

## Returns:

<NRf>...

## Example

FETC:POW:APP?

## **FETCh[:SCALar]:POWer:REACTive?**

## **MEASure[:SCALar]:POWer:REACTive?**

This command is used to read the reactive power value.

Note: this command parameter is optional. If there is no parameter, it will return the value of A, B, C three-phase by default.

## Syntax:

FETCh[:SCALar]:POWer:REACTive? [A|B|C]

MEASure[:SCALar]:POWer:REACTive? [A|B|C]

## Arguments

[A|B|C]

## Returns:

<NRf>...

## Example

FETC:POW:REAC?

## **FETCh[:SCALar]:POWer:PFACTOR?**

## **MEASure[:SCALar]:POWer:PFACTOR?**

This command is used to read the power factor value.

Note: this command parameter is optional. If there is no parameter, it will return the value of A, B, C three-phase by default.

## Syntax:

FETCh[:SCALar]:POWer:PFACTOR? [A|B|C]

MEASure[:SCALar]:POWer:PFACTOR? [A|B|C]

## Arguments

[A|B|C]

Returns:

<NRf>...

Example

FETC:POW:PFAC?

## **FETCh[:SCALar]:VOLTage[:AC]?**

## **MEASure[:SCALar]:VOLTage[:AC]?**

This command is used to read the effective value of voltage.

Note: this command parameter is optional. If there is no parameter, it will return the value of A, B, C three-phase by default.

Syntax:

FETCh[:SCALar]:VOLTage? [A|B|C]

MEASure[:SCALar]:VOLTage[:AC]? [A|B|C]

Arguments

[A|B|C]

Returns:

<NRf>...

Example

FETC:VOLT?

## **FETCh[:SCALar]:VOLTage:DC?**

## **MEASure[:SCALar]:VOLTage:DC?**

This command is used to read the DC component of voltage.

Note: this command parameter is optional. If there is no parameter, it will return the value of A, B, C three-phase by default.

Syntax:

FETCh[:SCALar]:VOLTage:DC? [A|B|C]

MEASure[:SCALar]:VOLTage:DC? [A|B|C]

Arguments

[A|B|C]

Returns:

<NRf> ...

## Example

```
FETC:VOLT:DC?
```

**FETCh[:SCALar]:VOLTage[:AC][:AMPLitude]:MAXimum?****MEASure[:SCALar]:VOLTage[:AC][:AMPLitude]:MAXimum?**

This command is used to read the peak value of voltage.

Note: this command parameter is optional. If there is no parameter, it will return the value of A, B, C three-phase by default.

## Syntax:

```
FETCh[:SCALar]:VOLTage[:AC][:AMPLitude]:MAXimum?
```

```
MEASure[:SCALar]:VOLTage[:AC][:AMPLitude]:MAXimum?
```

## Arguments

```
[A|B|C]
```

## Returns:

```
<NRf>...
```

## Example

```
FETC:VOLT:AMP:MAX?
```

**FETCh[:SCALar]:VOLTage[:AC][:AMPLitude]:MAXimum:POSitive?****MEASure[:SCALar]:VOLTage[:AC][:AMPLitude]:MAXimum:POSitive?**

This command is used to read the positive peak value of voltage.

Note: this command parameter is optional. If there is no parameter, it will return the value of A, B, C three-phase by default.

## Syntax:

```
FETCh[:SCALar]:VOLTage[:AC][:AMPLitude]:MAXimum:POSitive?
```

```
MEASure[:SCALar]:VOLTage[:AC][:AMPLitude]:MAXimum:POSitive?
```

## Arguments

```
[A|B|C]
```

## Returns:

```
<NRf> ...
```

## Example

```
FETC:VOLT:MAX:POS?
```

## FETCh[:SCALar]:VOLTage[:AC][:AMPLitude]:MAXimum:NEGative?

## MEASure[:SCALar]:VOLTage[:AC][:AMPLitude]:MAXimum:NEGative?

This command is used to read the negative peak value of voltage.

Note: this command parameter is optional. If there is no parameter, it will return the value of A, B, C three-phase by default.

### Syntax:

```
FETCh[:SCALar]:VOLTage[:AC][:AMPLitude]:MAXimum:NEGative?
```

```
MEASure[:SCALar]:VOLTage[:AC][:AMPLitude]:MAXimum:NEGative?
```

### Arguments

[A|B|C]

### Returns:

<NRf> ...

### Example

```
FETC:VOLT:MAX:NEG?
```

## FETCh[:SCALar]?

## MEASure[:SCALar]?

This command is used to get all METER data.

Note: this command parameter is optional. If there is no parameter, it will return the value of A, B, C three-phase by default.

### Syntax:

```
FETCh[:SCALar]? [A|B|C]
```

```
MEASure[:SCALar]? [A|B|C]
```

### Arguments

[A|B|C]

### Returns:

<NRf> ...

### Example

```
FETC? A
```

FETCh? If set the parameter [A|B|C], the returned 19 floating point measurements are <float>,...,<float> , in order are

(Uac,Iac,P,Upp,Upn,Ipp,Ipn,Freq,CF,PF,S,Q,Udc,Idc,Uthd,lthd,Upeak,Urms,Irms)

MEASure? If set the parameter [A|B|C], the returned 17 floating point measurements are <float>,...,<float> , in order are

(Uac,Iac,P,Upp,Upn,Ipp,Ipn,Freq,CF,PF,S,Q,Udc,Idc,Uthd,lthd,Upeak)

## **FETCh[:SCALar]:POWer[:REAL]:TOTal?**

### **MEASure[:SCALar]:POWer[:REAL]:TOTal?**

This command is used to read the total power value.

#### Syntax:

FETCh[:SCALar]:POWer [:REAL]:TOTal?

MEASure[:SCALar]:POWer[:REAL]:TOTal?

#### Arguments

Null

#### Returns:

<NRf>

#### Example

FETC:POW:TOT?

## **FETCh[:SCALar]:POWer:APParent:TOTal?**

### **MEASure[:SCALar]:POWer:APParent:TOTal?**

This command is used to read the total apparent power value.

#### Syntax:

FETCh[:SCALar]:POWer:APParent:TOTal?

MEASure[:SCALar]:POWer:APParent:TOTal?

#### Arguments

Null

#### Returns:

<NRf>

#### Example

FETC:POW:APP:TOT?

## **FETCh[:SCALar]:POWer:REACtive:TOTal?**

### **MEASure[:SCALar]:POWer:REACtive:TOTal?**

This command is used to read the total reactive power value.

**Syntax:**

```
FETCh[:SCALar]:POWer:REACtive:TOTal?  
MEASure[:SCALar]:POWer:REACtive:TOTal?
```

**Arguments**

Null

**Returns:**

<NRf>

**Example**

```
FETC:POW:REAC:TOT?
```

**FETCh[:SCALar]:LTLVoltage[:AC]?****MEASure[:SCALar]:LTLVoltage[:AC]?**

This command is used to read the line voltage value between B and A, or between C and A, or between C and B.

**Syntax:**

```
FETCh[:SCALar]:LTLVoltage? <BA|CA|CB>  
MEASure[:SCALar]:LTLVoltage[:AC]? <BA|CA|CB>
```

**Arguments**

<BA|CA|CB>

**Returns:**

<NRf>

**Example**

```
FETC:LTLV? CB
```

**FETCh[:SCALar]:VOLTage:HARMonic[:AMPLitude]?  
<[A|B|C]>,<NR1>****MEASure[:SCALar]:VOLTage:HARMonic[:AMPLitude]?  
<[A|B|C]>,<NR1>**

This command is used to measure the amplitude of voltage harmonics.

**Syntax:**

```
FETCh[:SCALar]:VOLTage:HARMonic[:AMPLitude]? <[A|B|C]>,<NR1>  
MEASure[:SCALar]:VOLTage:HARMonic[:AMPLitude]? <[A|B|C]>,<NR1>
```

**Arguments**

<[A|B|C]>,<NR1>

NR1 range: 0-50

Returns:

<NRf>

Example

FETC:VOLT:HARM? A,4

**FETCh[:SCALar]:CURRent:HARMonic[:AMPLitude]?  
<[A|B|C|CH1|CH2|CH3]>,<NR1>**

**MEASure[:SCALar]:CURRent:HARMonic[:AMPLitude]?  
<[A|B|C|CH1|CH2|CH3]>,<NR1>**

This command is used to measure the amplitude of current harmonics.

Syntax:

FETCh[:SCALar]:CURRent:HARMonic[:AMPLitude]?  
<[A|B|C|CH1|CH2|CH3]>,<NR1>

MEASure[:SCALar]:CURRent:HARMonic[:AMPLitude]?  
<[A|B|C|CH1|CH2|CH3]>,<NR1>

Arguments

<[A|B|C|CH1|CH2|CH3]>,<NR1>

NR1 range: 0-50

Returns:

<NRf>

Example

FETC:CURR:HARM? A,5

**FETCh[:SCALar]:VOLTage:HARMonic:DISTort?  
<[A|B|C]>,<NR1>**

**MEASure[:SCALar]:VOLTage:HARMonic:DISTort?  
<[A|B|C]>,<NR1>**

This command is used to measure voltage harmonic components.

Syntax:

FETCh[:SCALar]:VOLTage:HARMonic:DISTort? <[A|B|C]>,<NR1>

MEASure[:SCALar]:VOLTage:HARMonic:DISTort? <[A|B|C]>,<NR1>

### Arguments

<[A|B|C|CH1|CH2|CH3]>,<NR1>

NR1 range: 0-50

### Returns:

<NRf>

### Example

FETC:VOLT:HARM:DIST? A,8

## **FETCh[:SCALar]:CURRent:HARMonic:DISTort? <[A|B|C]>,<NR1>**

## **MEASure[:SCALar]:CURRent:HARMonic:DISTort? <[A|B|C]>,<NR1>**

This command is used to measure current harmonic components.

### Syntax:

FETCh[:SCALar]:CURRent:HARMonic:DISTort? <[A|B|C]>,<NR1>

### Arguments

<[A|B|C|CH1|CH2|CH3]>,<NR1>

NR1 range: 0-50

### Returns:

<NRf>

### Example

FETC:CURR:HARM:DIST? CH3,10

## **FETCh[:SCALar]:VOLTage:HARMonic:PHASe? <[A|B|C]>,<NR1>**

## **MEASure[:SCALar]:VOLTage:HARMonic:PHASe? <[A|B|C]>,<NR1>**

This command is used to measure the phase of voltage harmonics.

### Syntax:

FETCh[:SCALar]:VOLTage:HARMonic:PHASe? <[A|B|C]>,<NR1>

MEASure[:SCALar]:VOLTage:HARMonic:PHASe? <[A|B|C]>,<NR1>

### Arguments

<[A|B|C]>,<NR1>

NR1 range: 0-50

Returns:

<NRf>

Example

FETC:VOLT:HARM:PHAS? A,5

**FETCh[:SCALar]:CURRent:HARMonic:PHASe?  
<[A|B|C]>,<NR1>**

**MEASure[:SCALar]:CURRent:HARMonic:PHASe?  
<[A|B|C]>,<NR1>**

This command is used to measure the phase of current harmonics.

Syntax:

FETCh[:SCALar]:CURRent:HARMonic:PHASe? <[A|B|C]>,<NR1>

MEASure[:SCALar]:CURRent:HARMonic:PHASe? <[A|B|C]>,<NR1>

Arguments

<[A|B|C]>,<NR1>

NR1 range: 0-50

Returns:

<NRf>

Example

FETC:CURR:HARM:PHAS? A,10

**FETCh[:SCALar]:VOLTage:HARMonic:THD? <[A|B|C]>**

**MEASure[:SCALar]:VOLTage:HARMonic:THD?  
<[A|B|C]>**

This command is used to measure the total harmonic distortion of the voltage.

Syntax:

FETCh[:SCALar]:VOLTage:HARMonic:THD? <[A|B|C]>

MEASure[:SCALar]:VOLTage:HARMonic:THD? <[A|B|C]>

Arguments

<[A|B|C]>

Returns:

<NRf>

Example

FETC:VOLT:HARM:THD? C

**FETCh[:SCALar]:CURRent:HARMonic:THD? <[A|B|C]>**

**MEASure[:SCALar]:CURRent:HARMonic:THD?  
<[A|B|C]>**

This command is used to measure the total harmonic distortion of the current.

Syntax:

FETCh[:SCALar]:CURRent:HARMonic:THD? <[A|B|C]>

MEASure[:SCALar]:CURRent:HARMonic:THD? <[A|B|C]>

Arguments

<[A|B|C]>

Returns:

<NRf>

Example

FETC:CURR:HARM:THD? A

**FETCh[:SCALar]:ARRay:VOLTage:HARMonic[:AMPLitude]? <[A|B|C]>,<NR1>**

**MEASure[:SCALar]:ARRay:VOLTage:HARMonic[:AMPLitude]? <[A|B|C]>,<NR1>**

This command is used to measure each harmonic amplitude of the voltage.

Meaning: the value range of NR1 is 0-50, the 0th order represents the DC component, the 1st order represents the fundamental wave, and the 2nd to 50th order the harmonic components. In this command, if NR1 is assigned a value of 10, the result will list the harmonic amplitude of the voltage from 0 to 10th.

Syntax:

FETCh[:SCALar]:ARRay:VOLTage:HARMonic[:AMPLitude]? <[A|B|C]>,<NR1>

Arguments

<[A|B|C]>,<NR1>

NR1 range: 0-50

Returns:

<NRf>

Example

FETC:ARR:VOLT:HARM? B,11

**FETCh[:SCALar]:ARRay:CURRent:HARMonic[:AMPLitude]? <[A|B|C]>,<NR1>**

**MEASure[:SCALar]:ARRay:CURRent:HARMonic[:AMPLitude]? <[A|B|C]>,<NR1>**

This command is used to measure each harmonic amplitude of the current.

Syntax:

FETCh[:SCALar]:ARRay:CURRent:HARMonic[:AMPLitude]? <[A|B|C]>,<NR1>

MEASure[:SCALar]:ARRay:CURRent:HARMonic[:AMPLitude]? <[A|B|C]>,<NR1>

Arguments

<[A|B|C]>,<NR1>

NR1 range: 0-50

Returns:

<NRf>

Example

FETC:ARR:CURR:HARM? A,6

**FETCh[:SCALar]:ARRay:VOLTage:HARMonic:PHASe? <[A|B|C]>,<NR1>**

**MEASure[:SCALar]:ARRay:VOLTage:HARMonic:PHASe? <[A|B|C]>,<NR1>**

This command is used to measure each harmonic phase of the voltage.

Syntax:

FETCh[:SCALar]:ARRay:VOLTage:HARMonic:PHASe? <[A|B|C]>,<NR1>

MEASure[:SCALar]:ARRay:VOLTage:HARMonic:PHASe? <[A|B|C]>,<NR1>

Arguments

<[A|B|C]>,<NR1>

NR1: 0-50

Returns:

<NRf>

Example

FETC:ARR:VOLT:HARM:PHAS? CH3,6

**FETCh[:SCALar]:ARRay:CURRent:HARMonic:PHASe?  
<[A|B|C]>,<NR1>**

**MEASure[:SCALar]:ARRay:CURRent:HARMonic:PHASe?  
<[A|B|C]>,<NR1>**

This command is used to measure each harmonic phase of the current.

Syntax:

FETCh[:SCALar]:ARRay:CURRent:HARMonic:PHASe? <[A|B|C]>,<NR1>

MEASure[:SCALar]:ARRay:CURRent:HARMonic:PHASe? <[A|B|C]>,<NR1>

Arguments

<[A|B|C|CH1|CH2|CH3]>,<NR1>

NR1: 0-50

Returns:

<NRf>

Example

FETC:ARR:CURR:HARM:PHAS? A,4

**FETCh[:SCALar]:ARRay:VOLTage:HARMonic:DISort?  
<[A|B|C|CH1|CH2|CH3]>,<NR1>**

**MEASure[:SCALar]:ARRay:VOLTage:HARMonic:DISort?  
t? <[A|B|C|CH1|CH2|CH3]>,<NR1>**

This command is used to measure each harmonic distortion of the voltage.

Syntax:

FETCh[:SCALar]:ARRay:VOLTage:HARMonic:DISort?

<[A|B|C|CH1|CH2|CH3]>,<NR1>

MEASure[:SCALar]:ARRay:VOLTage:HARMonic:DISort?

<[A|B|C|CH1|CH2|CH3]>,<NR1>

Arguments

<[A|B|C|CH1|CH2|CH3]>,<NR1>

NR1: 0-50

Returns:

<NRf>

Example

FETC:ARR:VOLT:HARM:DIST? A,6

**FETCh[:SCALar]:ARRay:CURRent:HARMonic:DISTort?  
<[A|B|C|CH1|CH2|CH3]>,<NR1>**

**MEASure[:SCALar]:ARRay:CURRent:HARMonic:DISTor  
t? <[A|B|C|CH1|CH2|CH3]>,<NR1>**

This command is used to measure each harmonic distortion of the current.

Syntax:

FETCh[:SCALar]:ARRay:CURRent:HARMonic:DISTort?  
<[A|B|C|CH1|CH2|CH3]>,<NR1>

MEASure[:SCALar]:ARRay:CURRent:HARMonic:DISTort?  
<[A|B|C|CH1|CH2|CH3]>,<NR1>

Arguments

<[A|B|C|CH1|CH2|CH3]>,<NR1>

NR1: 0-50

Returns:

<NRf>

Example

FETC:ARR:CURR:HARM:DIST? A,6

**VETCor:OEDer <NR1>**

This command is used to set and query the order of the vector diagram.

Syntax:

VETCor:OEDer

Arguments

<NR1> range: 0-50

Returns:

<NRf>

Query syntax:

VETC:OED?

## Example

VETC:OED 19

## VETCor:DATA?

This command is used to query the vector data of present order.

### Syntax:

VETCor:DATA?

### Arguments

Null

### Returns:

<NRf>,<NRf>,<NRf>,<NRf>,<NRf>,<NRf>

## Example

VETCor:DATA?

## VETCor:TYPE <CPD>

This command is used to set the vector type.

### Syntax:

VETCor:TYPE <CPD>

### Arguments

<U||ALL>

### Returns:

U||ALL

### Query syntax:

VETCor:TYPE??

## Example

VETC:TYPE I

---

## Chapter29 SENSE Subsystem (Load)

---

### **SENSe[:REMOte][:STATe] <CPD>**

This command enables or disables the sense function.

Syntax:

```
SENSe[:REMOte][:STATe] <CPD>
```

Arguments

```
<OFF|ON|0|1>
```

Default

```
0|OFF
```

Query syntax:

```
SENSe[:REMOte][:STATe]?
```

Returns:

```
<OFF|ON|0|1>
```

Example

```
SENS ON
```

### **SENSe:FILTer[:STATe] <CPD>**

This command sets and queries the state of meter filter switch.

Syntax:

```
SENSe:FILTer[:STATe] <CPD>
```

Arguments

```
0|OFF|1|ON
```

Query syntax:

```
SENSe:FILTer[:STATe]?
```

Returns:

```
0|OFF|1|ON
```

Example

```
SENSe:FILT OFF
```

### **SENSe:FILTer:LEVel <CPD>**

This command is used to set and query the filter level of the meter.

**Syntax:**

SENSe:FILTer:LEVel <CPD>

**Arguments**

SLOW|MEDIUM|FAST

**Query syntax:**

SENSe:FILTer:LEVel?

**Returns:**

SLOW|MEDIUM|FAST

**Example**

SENS:FILT:LEV FAST

## **SENSe:EXTeRnal:SYNC[:STATe] <boolean>**

This command is used to set and query the state of synchronization.

**Syntax:**

SENSe:EXTeRnal:SYNC[:STATe] <boolean>

**Arguments**

0|OFF|1|ON

**Query syntax:**

SENSe:EXTeRnal:SYNC[:STATe]?

**Returns:**

0|1

**Example**

SENS:EXT:SYNC 1

## **SENSe:EXTeRnal:SYNC:PHASe <NRf>**

Set the angle difference between the instrument and the external signal frequency. When the external frequency lock function is turned on, the output phase of the instrument maintains a fixed angle difference with the external frequency.

**Syntax:**

SENSe:EXTeRnal:SYNC:PHASe <NRf>

**Arguments**

MAXimum|MINimum

**Query syntax:**

SENSe:EXTeRnal:SYNC:PHASe?

Returns:

<NRf>

Example

SENS:EXT:SYNC:PHAS 90

## **SENSe:EXTeRnal:SYNC:DIFFerence <CPD>,<NRf>**

This command sets the instrument B to A and C to A angle difference. Editable under 3 phase only.

Syntax:

SENSe:EXTeRnal:SYNC:DIFFerence <CPD>,<NRf>

Arguments

CPD:BA|CA

NRf:MAXimum|MINimum

Query syntax:

SENSe:EXTeRnal:SYNC:DIFFerence? <CPD>

Returns:

<NRf>

Example

SENSe:EXTeRnal:SYNC:DIFFerence <CPD>,<NRf>

## Chapter30 Load Protect Subsystem (Load)

### [**SOURce:**]PROTection:AUTO:CLEAr[:STATe] <Boolean>

This command is used to set the state of the protection auto-clear function.

Syntax:

PROTection:AUTO:CLEAr[:STATe] <Boolean>

Arguments

0|1|OFF|ON

Query syntax:

PROTection:AUTO:CLEAr[:STATe]?

Example:

PROT:AUTO:CLE 1

### [**SOURce:**]CURRent:PROTection:STATe <Boolean>

This command is used to set state of over current RMS protection.

Syntax:

CURRent:PROTection:STATe <Boolean>

Arguments

0|1|OFF|ON

Query syntax:

CURRent:PROTection:STATe?

Returns:

0|1|OFF|ON

Example

CURR:PROT:STAT 1

### [**SOURce:**]CURRent:PROTection[:LEVeI] <NRf+>

The command sets the protection value of current RMS protection, unit: A.

Syntax:

CURRent:PROTection[:LEVeI] <NRf+>

Arguments

0|1|OFF|ON

Query syntax:

CURRent:PROTection[:LEVel]? [MAXimum|MINimum]

Returns:

0|1|OFF|ON

Example

CURRent:PROTection 90

### **[SOURce:]CURRent:PROTection:DELaY <NRf+>**

Set the RMS current protection delay time, the unit is: s

Syntax:

CURRent:PROTection:DELaY <NRf+>

Arguments

<MINimum-MAXimum>

Query syntax:

[SOURce:]CURRent:PROTection:DELaY?

Returns:

<MINimum-MAXimum>

Example

CURR:PROT:DEL 0.5

CURR:PROT:DEL 10

### **[SOURce:]CURRent:PEAK:PROTection:STATe <Boolean>**

This command is used to set state of over current peak protection.

Syntax:

CURRent:PEAK:PROTection:STATe <Boolean>

Arguments

0|1|OFF|ON

Query syntax:

CURRent:PEAK:PROTection:STATe?

Returns:

0|1|OFF|ON

Example

CURRent:PEAK:PROTection:STATe 1

**[SOURCE:]CURRENT:PEAK:PROTECTION[:LEVEL] <NRf+>**

The command sets the protection value of current peak protection, unit: A.

## Syntax:

CURRENT:PEAK:PROTECTION[:LEVEL] <NRf+>

## Arguments

<MINimum-MAXimum>

## Query syntax:

CURRENT:PEAK:PROTECTION[:LEVEL]? [MAXimum|MINimum]

## Returns:

MAXimum|MINimum|DEFault

## Example

CURRENT:PEAK:PROT 30

**[SOURCE:]CURRENT:PEAK:PROTECTION:DELAY <NRf+>**

Set the peak current protection delay time, the unit is: s

## Syntax:

CURRENT:PEAK:PROTECTION:DELAY <NRf+>

## Arguments

MAXimum|MINimum|DEFault

## Query syntax:

CURRENT:PEAK:PROTECTION:DELAY?

## Returns:

[MAXimum|MINimum]

## Example

CURRENT:PEAK:PROTECTION:DELAY 1

**[SOURCE:]POWER:PROTECTION:STATE <Boolean>**

Sets the state of over power protection.

## Syntax:

POWER:PROTECTION:STATE <Boolean>

## Arguments

0|1|OFF|ON

Query syntax:

POWER:PROTECTION:STATE?

Returns:

0|1|OFF|ON

Example

POWER:PROTECTION:STATE 1

## **[SOURCE:]POWER:PROTECTION[:LEVEL] <NRf+>**

The command sets the protection value of power protection, unit: w.

Syntax:

POWER:PROTECTION[:LEVEL] <NRf+>

Arguments

<MINimum-MAXimum>

Query syntax:

POWER:PROTECTION[:LEVEL]? [MAXimum|MINimum]

Returns:

MAXimum|MINimum|DEFault

Example

POWER:PROTECTION 30

## **[SOURCE:]POWER:PROTECTION:DELAY <NRf+>**

Set the power protection delay time, the unit is: s

Syntax:

POWER:PROTECTION:DELAY <NRf+>

Arguments

<MINimum-MAXimum>

Query syntax:

POWER:PROTECTION:DELAY? [MAXimum|MINimum]

Returns:

<MINimum-MAXimum>

Example

POWER:PROTECTION:DELAY 1

## **[SOURce:]VOLTage:UNDER:PROTection:STATe <Boolean>**

Sets the state of the undervoltage protection. Setting is only required when in DC mode.

### Syntax:

POWER:PROTection:STATe <Boolean>

### Arguments

0|1|OFF|ON

### Query syntax:

VOLTage:UNDER:PROTection:STATe?

### Returns:

0|1|OFF|ON

### Example

VOLTage:UNDER:PROTection:STATe 1

## **[SOURce:]VOLTage:UNDER:PROTection[:LEVel] <NRf+>**

Sets the undervoltage protection value in the DC mode of the machine. The unit is V. It needs to be set only when in DC mode.

### Syntax:

VOLTage:UNDER:PROTection[:LEVel] <NRf+>

### Arguments

<MINimum-MAXimum>

### Query syntax:

VOLTage:UNDER:PROTection[:LEVel]? [MAXimum|MINimum]

### Returns:

MAXimum|MINimum|DEFault

### Example

VOLTage:UNDER:PROTection 30

## **[SOURce:]VOLTage:UNDER:PROTection:DELAy <NRf+>**

This command is used to set the undervoltage protection delay time in s. It only needs to be set when in DC mode.

**Syntax:**

VOLTage:UNDer:PROTection:DELaY <NRf+>

**Arguments**

<MINimum-MAXimum>

**Query syntax:**

VOLTage:UNDer:PROTection:DELaY? [MAXimum|MINimum]

**Returns:**

<MINimum-MAXimum>

**Example**

VOLTage:UNDer:PROTection:DELaY 1

## **[SOURce:]VOLTage:PEAK:PROTection[:LEVel] <NRf+>**

Sets the upper voltage peak limit.

**Syntax**

VOLTage:PEAK:PROTection[:LEVel] <NRf+>

**Arguments**

<MINimum-MAXimum>

**Query syntax**

VOLTage:PEAK:PROTection[:LEVel]? [MAXimum|MINimum]

**Returns**

<MINimum-MAXimum>

**Example**

VOLTage:PEAK:PROTection 350

## **[SOURce:]VOLTage:PEAK:PROTection:DELaY <NRf+>**

Sets the delay time for voltage peak protection.

**Syntax**

VOLTage:PEAK:PROTection:DELaY <NRf+>

**Arguments**

<MINimum-MAXimum>

**Query syntax**

VOLTage:PEAK:PROTection:DELaY? [MAXimum|MINimum]

**Returns**

&lt;MINimum-MAXimum&gt;

**Example**

VOLTage:PEAK:PROTection:DELay 1.0

**[SOURce:]UUT:ABNormal:PROTection:STATe  
<Boolean>**

Sets the UUT output voltage abnormal protection status.

**Syntax:**

UUT:ABNormal:PROTection:STATe &lt;Boolean&gt;

**Arguments**

0|1|OFF|ON

**Query syntax:**

UUT:ABNormal:PROTection:STATe?

**Returns:**

0|1

**Example**

UUT:ABNormal:PROTection:STATe 0

**[SOURce:]UUT:ABNormal:PROTection:MODE <CPD>**

Sets the UUT output voltage abnormal protection mode.

**Syntax:**

UUT:ABNormal:PROTection:MODE &lt;CPD&gt;

**Arguments**

SHUTup|LIMit

**Query syntax:**

UUT:ABNormal:PROTection:MODE?

**Returns:**

SHUTup|LIMit

**Example**

UUT:ABNormal:PROTection:MODE LIMit

**[SOURce:]FREQuency:PROTection:UPPer <NRf+>**

Sets the frequency error protection upper limit. Unit: Hz

**Syntax:**

FREQuency:PROTection:UPPer &lt;NRf+&gt;

**Arguments**

&lt;MINimum-MAXimum&gt;

**Query syntax:**

UUT:ABNormal:PROTection:STATe?

**Returns:**

&lt;MINimum-MAXimum&gt;

**Example**

FREQuency:PROTection:UPPer 70

**[SOURCE:]FREQuency:PROTection:LOWer <NRf+>**

Sets the frequency error protection lower limit. Unit: Hz

**Syntax:**

FREQuency:PROTection:LOWer &lt;NRf+&gt;

**Arguments**

&lt;MINimum-MAXimum&gt;

**Query syntax:**

FREQuency:PROTection:LOWer?

**Returns:**

&lt;MINimum-MAXimum&gt;

**Example**

FREQuency:PROTection:LOWer 40

## Chapter31 SOURce Subsystem (Load)

### [SOURce:]SYSTem:FUNCTion <CPD>

This command is used to set the mode of present load, including single-phase/three-phase/reverse.

Syntax:

SYSTem:FUNCTion <CPD>

Arguments:

ONE|THRee|DIFFerence

Default:

ONE

Query syntax:

SYSTem:FUNCTion?

Returns:

ONE|THRee|DIFFerence

Example:

SYST:FUNC ONE

### [SOURce:]FUNCTion <CPD1>

This command is used to set load mode.

Syntax:

FUNCTion <CPD1>

Arguments:

AC mode: CC|CR|CP|CS|CC+CR|CE

DC mode: CC|CR|CP|CV|CC+CV|CR+CV|CP+CV|CR+CC|CC+CR+CP+CV

Query syntax:

FUNCTion?

Returns:

AC mode: CC|CR|CP|CS|CC+CR|CE

DC mode: CC|CR|CP|CV|CC+CV|CR+CV|CP+CV|CR+CC|CC+CR+CP+CV

Example:

FUNC CC

## [SOURce:]FUNction:CATalog?

This command is used to query the supports load mode.

### Syntax:

[SOURce:]FUNction:CATalog?

### Arguments

AC: CC|CR|CP|CS|CC+CR|CE

DC: CC|CR|CP|CV|CC+CV|CR+CV|CP+CV|CR+CC|CC+CR+CP+CV

### Arguments

AC: CC|CR|CP|CS|CC+CR|CE

DC: CC|CR|CP|CV|CC+CV|CR+CV|CP+CV|CR+CC|CC+CR+CP+CV

### Example

FUNC:CAT? //query the load mode catalog

## [SOURce:]UPFactor[:STATe] <Boolean>

This command is used to set state of UPF (Unit Power Factor)

### Syntax:

UPFactor[:STATe] <Boolean>

### Arguments

<0|1|OFF|ON>

### Query syntax:

UPFactor[:STATe]?

### Returns:

<0|1|OFF|ON>

### Example

UPFactor 1

## [SOURce:]CURRent[:LEVeL][:IMMediate][:AMPLitude][:AC] <NRf+>[,NRf+][,NRf+]

Set and query the upper limit of RMS current.

### Syntax:

CURRent[:LEVeL][:IMMediate][:AMPLitude][:AC] <NRf+>[,NRf+][,NRf+]

### Arguments

<NRf+>

MAXimum|MINimum

Query syntax:

CURRent[:LEVel][:IMMediate][:AMPLitude][:AC]? [MAXimum|MINimum]

Returns:

MAXimum|MINimum

Example

CURR 30  
CURR 30,20,10

## **[SOURce:]CURRent[:LEVel][:IMMediate][:AMPLitude]:DC <NRf+>,[NRf+],[NRf+]**

DC current limit value setting command in Normal mode. This command is valid only in DC and DC+AC modes.

Syntax:

CURRent[:LEVel][:IMMediate][:AMPLitude]:DC <NRf+>,[NRf+],[NRf+]

Query syntax:

CURRent[:LEVel][:IMMediate][:AMPLitude]:DC?

Returns:

<NRf+>

Example

CURRent:DC 30

## **[SOURce:]CURRent:SLEW[:AC] <NRf+>,[NRf+],[NRf+]**

Sets the slope of load current. Unit A/ms.

Syntax:

CURRent:SLEW[:AC] <NRf+>,[NRf+],[NRf+]

Arguments

<NRf+>,[NRf+],[NRf+]

Query syntax:

CURRent:SLEW[:AC]? [MAXimum|MINimum]

Example

CURR:SLEW 20.0 //set the current slope to 20.0A/ms

## **[SOURce:]CURRent:SLEW:DC <NRf+>**

Sets the slope of the current in DC mode. Unit A/ms.

**Syntax:**

CURRent:SLEW:DC <NRf+>

**Arguments**

<NRf+>

**Query syntax:**

CURRent:SLEW:DC? [MAXimum|MINimum]

**Example**

CURR:SLEW:DC 20.0

**[SOURCE:]RESistance[:LEVel][:IMMediate][:AMPLitude]  
<NRf+>[,NRf+][,NRf+]**

Sets the resistance value. Unit W.

**Syntax:**

RESistance[:LEVel][:IMMediate][:AMPLitude] <NRf+>[,NRf+][,NRf+]

**Query syntax:**

RESistance[:LEVel][:IMMediate][:AMPLitude]? [MAXimum|MINimum]

**Arguments:**

<NRf+>[,NRf+][,NRf+]

**Example:**

RESistance 500

**[SOURCE:]POWER[:LEVel][:IMMediate][:AMPLitude]  
<NRf+>[,NRf+][,NRf+]**

Sets the power value. Unit W.

**Syntax:**

POWER[:LEVel][:IMMediate][:AMPLitude] <NRf+>[,NRf+][,NRf+]

**Query syntax:**

POWER[:LEVel][:IMMediate][:AMPLitude]? [MAXimum|MINimum]

**Arguments**

<NRf+>[,NRf+][,NRf+]

**Example:**

POWER 500

## **[SOURCE:]KVA[:LEVEL][:IMMEDIATE][:AMPLITUDE] <NRf+>[,NRf+][,NRf+]**

This command is used to set or query the apparent power under CS mode. Unit kVA.

Syntax:

KVA[:LEVEL][:IMMEDIATE][:AMPLITUDE] <NRf+>[,NRf+][,NRf+]

Query syntax:

KVA[:LEVEL][:IMMEDIATE][:AMPLITUDE]? [MAXimum] MINimum]

Arguments

<NRf+>[,NRf+][,NRf+]

Example:

KVA 10

## **[SOURCE:]PSHIFT[:LEVEL][:IMMEDIATE][:AMPLITUDE] <NRf+>[,NRf+][,NRf+]**

This command is used to set or query the phase shift between voltage and current.

Syntax:

PSHIFT[:LEVEL][:IMMEDIATE][:AMPLITUDE] <NRf+>[,NRf+][,NRf+]

Arguments

-90° ~ +90°

Query syntax:

PSHIFT[:LEVEL][:IMMEDIATE][:AMPLITUDE]? [MAXimum] MINimum]

Arguments

<NRf+>[,NRf+][,NRf+]

Example:

PSHIFT 90

PSHIFT?

## **[SOURCE:]CFACtor[:LEVEL][:IMMEDIATE][:AMPLITUDE] <NRf+>[,NRf+][,NRf+]**

This command is used to set or query CF.

Syntax:

CFACtor[:LEVEL][:IMMEDIATE][:AMPLITUDE] <NRf+>[,NRf+][,NRf+]

## Arguments

1.414 ~ 5

## Query syntax:

CFACtor[:LEVel][:IMMEDIATE][:AMPLitude]? [MAXimum|MINimum]

## Arguments

<NRf+>[,NRf+][,NRf+]

## Example:

CFACtor 5

CFACtor?

## **[SOURce:]VOLTage[:LEVel][:IMMEDIATE][:AMPLitude] <NRf+>**

This command is used to set or query voltage value of DC mode.

## Syntax:

VOLTage[:LEVel][:IMMEDIATE][:AMPLitude] <NRf+>

## Arguments

<NRf+>

## Query syntax:

VOLTage[:LEVel][:IMMEDIATE][:AMPLitude]? [MAXimum|MINimum]

## Arguments

MAXimum|MINimum|DEFault

## Example:

VOLTage 20

## **[SOURce:]CE:PEAK:CURRent <NRf+>[,NRf+][,NRf+]**

This command is used to set or query Ipeak value of CE mode.

## Syntax:

CE:PEAK:CURRent <NRf+>[,NRf+][,NRf+]

## Arguments

MAXimum|MINimum|DEFault

## Query syntax:

CE:PEAK:CURRent? [MAXimum|MINimum]

## Arguments

MAXimum|MINimum|DEFault

## Example:

CE:PEAK:CURRENT 30

## **[SOURce:]CE:TYPE <CPD>**

This command is used to select or query CE type.

## Syntax:

[SOURce:]CE:TYPE < A|B>

## Arguments

A|B|1|2|3|4|5|6|7|8|9|10|11|12|13|14|15

A: Parallel RLC

B: Rectifier single phase RLC

## Query syntax:

[SOURce:]CE:TYPE?

## Example:

CE:TYPE A

## **[SOURce:]CE:TA:R <NRf+>[,NRf+][,NRf+]**

This command is used to set or query the R set under Parallel RLC, Unit:  $\Omega$

## Syntax:

[SOURce:]CE:TA:R <NRf+>[,NRf+][,NRf+]

## Arguments

<NRf+>[,NRf+][,NRf+]

## Query syntax:

[SOURce:]CE:TA:R? [MAXimum|MINimum]

## Arguments

<NRf+>

## Example:

CE:TA:R 100

## **[SOURce:]CE:TA:RL <NRf+>[,NRf+][,NRf+]**

This command is used to set or query the RL under Parallel RLC. Unit:  $\Omega$

Syntax:

[SOURce:]CE:TA:RL <NRf+>[,NRf+][,NRf+]

Query syntax:

[SOURce:]CE:TA:RL? [MAXimum|MINimum]

Example

CE:TA:RL 10

## **[SOURce:]CE:TA:L <NRf+>[,NRf+][,NRf+]**

This command is used to set or query the L value under Parallel RLC, Unit: mH

Syntax:

[SOURce:]CE:TA:L <NRf+>[,NRf+][,NRf+]

Query syntax:

[SOURce:]CE:TA:L? [MAXimum|MINimum]

Example

CE:TA:L 10

## **[SOURce:]CE:TA:RC <NRf+>[,NRf+][,NRf+]**

This command is used to set or query the RC value under Parallel RLC, Unit:  
Ω

Syntax:

[SOURce:]CE:TA:RC <NRf+>[,NRf+][,NRf+]

Arguments

<NRf+>[,NRf+][,NRf+]

Query syntax:

[SOURce:]CE:TA:RC? [MAXimum|MINimum]

Example

CE:TA:RC 10

## **[SOURce:]CE:TA:C <NRf+>[,NRf+][,NRf+]**

This command is used to set or query the C value under Parallel RLC, Unit: uF

Syntax:

[SOURce:]CE:TA:C <NRf+>[,NRf+][,NRf+]

Arguments

<NRf+>[,NRf+][,NRf+]

Query syntax:

[SOURce:]CE:TA:C? [MAXimum|MINimum]

Example

CE:TA:C 10

## **[SOURce:]CE:TA:L:AINitial <NRf+>[,NRf+][,NRf+]**

This command is used to set or query the initial current value of inductance, Unit: A.

Syntax:

[SOURce:]CE:TA:L:AINitial <NRf+>[,NRf+][,NRf+]

Arguments

<NRf+>[,NRf+][,NRf+]

Query syntax:

[SOURce:]CE:TA:L:AINitial? [MAXimum|MINimum]

Example

CE:TA:L:AINitial 10

## **[SOURce:]CE:TB:R <NRf+>[,NRf+][,NRf+]**

This command is used to set or query the R set under Rectifier single phase RLC mode, Unit:  $\Omega$

Syntax:

[SOURce:]CE:TB:R <NRf+>[,NRf+][,NRf+]

Arguments

<NRf+>[,NRf+][,NRf+]

Query syntax:

[SOURce:]CE:TB:R? [MAXimum|MINimum]

Arguments

<NRf+>

Example:

CE:TB:R 100

## **[SOURce:]CE:TB:RS <NRf+>[,NRf+][,NRf+]**

This command is used to set or query the RS set under Rectifier single phase RLC mode, Unit:  $\Omega$

Syntax:

[SOURce:]CE:TB:RS <NRf+>[,NRf+][,NRf+]

Query syntax:

[SOURce:]CE:TB:RS? [MAXimum|MINimum]

Example

CE:TB:RS 10

## **[SOURce:]CE:TB:L <NRf+>[,NRf+][,NRf+]**

This command is used to set or query the L value under Rectifier single phase RLC mode, Unit: mH

Syntax:

[SOURce:]CE:TB:L <NRf+>[,NRf+][,NRf+]

Query syntax:

[SOURce:]CE:TB:L? [MAXimum|MINimum]

Example

CE:TB:L 10

## **[SOURce:]CE:TB:C <NRf+>[,NRf+][,NRf+]**

This command is used to set or query the C value under Rectifier single phase RLC mode, Unit: uF

Syntax:

[SOURce:]CE:TB:C <NRf+>[,NRf+][,NRf+]

Arguments

<NRf+>[,NRf+][,NRf+]

Query syntax:

[SOURce:]CE:TB:C? [MAXimum|MINimum]

Example

CE:TB:C 10

## **[SOURce:]CE:TB:C:VINitial <NRf+>[,NRf+][,NRf+]**

This command is used to set or query the initial voltage value of capacitance, Unit: V.

Syntax:

[SOURce:]CE:TB:C:VINitial <NRf+>[,NRf+][,NRf+]

## Arguments

<NRf+>,[NRf+],[NRf+]

## Query syntax:

[SOURce:]CE:TB:C:VINitial? [MAXimum|MINimum]

## Example

CE:TB:C:VINitial 10

## **[SOURce:]CE:TB:D:VOLTage <NRf+>[,NRf+][,NRf+]**

This command is used to set or query diode voltage under Rectifier single phase RLC mode, Unit:V

## Syntax:

[SOURce:]CE:TB:D:VOLTage <NRf+>[,NRf+][,NRf+]

## Arguments

<NRf+>,[NRf+],[NRf+]

## Query syntax:

[SOURce:]CE:TB:D:VOLTage? [MAXimum|MINimum]

## Example

CE:TB:D:VOLTage 10

## **[SOURce:]PFACTOR[:LEVel][:IMMediate][:AMPLitude] <NRf+>[,NRf+][,NRf+]**

Setting the power factor parameter, often used with the PHASe:MODE command, can achieve the effect of the PSHift command, PHASe:MODE focusing on the power factor and the PSHift focusing the phase difference.

## Syntax:

[SOURce:]PFACTOR[:LEVel][:IMMediate][:AMPLitude] <NRf+>[,NRf+][,NRf+]

## Arguments:

MAXimum|MINimum

## Query syntax:

[SOURce:]PFACTOR[:LEVel][:IMMediate][:AMPLitude]? [MAXimum|MINimum]

## Example

PFACTOR 1.0

## **[SOURce:]PHASe:MODE <CPD>**

Sets the phase mode ahead or lag.

**Syntax:**

[SOURce:]PHASe:MODE <CPD>

**Arguments:**

<LEAD|LAG>

**Query syntax:**

[SOURce:]PHASe:MODE?

**Example**

PHASe:MODE LAG

## **[SOURce:]VOLTage:INHibit:VON[:LEVel] <NRf+>**

Sets the Von voltage in load DC mode.

**Syntax:**

[SOURce:]VOLTage:INHibit:VON[:LEVel] <NRf+>

**Arguments:**

MAXimum|MINimum

**Query syntax:**

[SOURce:]VOLTage:INHibit:VON[:LEVel]? [MAXimum| MINimum]

**Example**

VOLTage:INHibit:VON 20

## **[SOURce:]VOLTage:INHibit:VOFF[:LEVel] <NRf+>**

Sets the Voff voltage in load DC mode.

**Syntax:**

[SOURce:]VOLTage:INHibit:VOFF[:LEVel] <NRf+>

**Arguments:**

MAXimum|MINimum

**Query syntax:**

[SOURce:]VOLTage:INHibit:VOFF[:LEVel]? [MAXimum| MINimum]

**Example**

VOLTage:INHibit:VOFF 20

## **[SOURce:]VOLTage:INHibit:VON:MODE**

Sets the undervoltage mode in load DC mode.

- LATCHing: The input enabled value of the electronic load. When the power

supply voltage to be tested is greater than the Von setting value, the load starts to test, and the load will not off when the power supply voltage drops and is less than the Von setting value.

- LIVE: Turn on the Von and Voff function, when the input voltage is less than the Von setting value, the load will not carry the load; when the input voltage is less than the Voff setting value, the load will stop carrying the load.
- OFF: Disabling the von and voff functions

#### Syntax:

```
[SOURce:]VOLTage:INHibit:VON:MODE
```

#### Arguments:

```
MAXimum|MINimum
```

#### Query syntax:

```
[SOURce:]VOLTage:INHibit:VON:MODE?
```

#### Example

```
VOLTage:INHibit:VOFF 20
```

---

## Chapter32 Input Subsystem (Load)

---

### **INPut:COUPling <CPD>**

This command is used to switch AC and DC mode.

#### Syntax:

INPut|OUTPut:COUPling <CPD>

#### Arguments

DC|AC

#### Query syntax:

INPut:COUPling?

#### Returns:

DC|AC

#### Example

INPut:COUPling AC

### **INPut|OUTPut:PHASe:LOSS:A <STATE>**

This command is used to set the phase A is lost.

#### Syntax:

INPut|OUTPut:PHASe:LOSS:A <STATE>

#### Arguments:

0|OFF|1|ON

#### Query syntax:

INPut|OUTPut:PHASe:LOSS:A?

#### Example

INPut:PHASe:LOSS:A 1

### **INPut|OUTPut:PHASe:LOSS:B <STATE>**

This command is used to set the phase B is lost.

#### Syntax:

INPut|OUTPut:PHASe:LOSS:B <STATE>

#### Arguments:

0|OFF|1|ON

Query syntax:

```
INPut|OUTPut:PHASe:LOSS:B?
```

Example

```
INPut:PHASe:LOSS:B 1
```

## **INPut|OUTPut:PHASe:LOSS[:C] <STATE>**

This command is used to set the phase C is lost.

Syntax:

```
INPut|OUTPut:PHASe:LOSS[:C] <STATE>
```

Arguments:

```
0|OFF|1|ON
```

Query syntax:

```
INPut|OUTPut:PHASe:LOSS[:C]?
```

Example

```
INPut:PHASe:LOSS 1
```

## **INPut:LINE:CONNection <CPD>**

This command is used to set the connection status of the output. WYE is the star connection method and DELTaN is the triangle connection method.

Syntax:

```
INPut:LINE:CONNection <CPD>
```

Arguments

```
<WYE|DELTA>
```

Query syntax:

```
INPut:LINE:CONNection?
```

Returns:

```
<WYE|DELTA>
```

Example

```
INP:LINE:CONN WYE
```

## **INPut <state>**

This command is used to set the input state.

Syntax:

```
INPut <state>
```

## Arguments

0|OFF|1|ON

## Query syntax:

INPut[:STATe]?

## Returns:

0|OFF|1|ON

## Example

INP 1

## **INPut:RECTified[:STATe] <boolean>**

This command is used to set the state of rectified function.

## Syntax:

INPut:RECTified[:STATe] <boolean>

## Arguments

0|OFF|1|ON

## Query syntax:

INPut:RECTified[:STATe]?

## Returns:

0|OFF|1|ON

## Example

INPut:RECTified 1

## **INPut:INTEgrity <CPD>**

This command is used to set the integrity of the input waveform.

## Syntax:

INPut:INTEgrity <CPD>

## Arguments

<FULL|POSitive|NEGative>

## Query syntax:

INPut:INTEgrity?

## Returns:

<FULL|POSitive|NEGative>

## Example

INPut:INTegrity FULL

## INPut:PROTection:CLEar

This command is used to clear the protection status.

## Syntax:

INPut:PROTection:CLEar

## Example

INPut:PROTection:CLEar

## INPut:PROTection:WDOG[:STATe] <state>

This command is used to enable or disable the watch dog function.

## Syntax:

INPut:PROTection:WDOG[:STATe] <state>

## Arguments

0|OFF|1|ON

## Query syntax:

INPut|OUTPut:PROTection:WDOG[:STATe]?

## Example

INPut:PROTection:WDOG 1

## INPut:PROTection:WDOG:DELay <time>

This command is used to set software watchdog delay time, unit is s.

## Syntax:

INPut:PROTection:WDOG:DELay <time>

## Arguments

MINimum|MAXimum

## Query syntax:

INPut:PROTection:WDOG:DELay?

## Returns:

MINimum|MAXimum

## Example

INPut:PROTection:WDOG:DELay 1

## INPut:REGulation:SPEed <CPD>

This command is used to set the input regulation speed.

### Syntax:

INPut:REGulation:SPEed <CPD>

### Arguments

<SLOW|FAST>

### Query syntax:

INPut:REGulation:SPEed?

### Returns:

<SLOW|FAST>

### Example

INPut:REGulation:SPEed SLOW

## INPut:OFF:MODE <CPD>

This command is set the connection status when the load is off.

OPENz: disconnect the output relay and the output terminal is in a high-impedance state.

HIGHz: the output relay is closed and the output terminal is in a high-impedance state.

### Syntax:

INPut:OFF:MODE <CPD>

### Arguments

OPENz|HIGHz

### Query syntax:

INPut|OUTPut:OFF:MODE?

### Example

INPut:OFF:MODE <CPD>

## INPut:ON:PHASe:MODE <CPD>

This command is used to set the mode of phase control when the load input is turned on.

PHASe: The load starts input with the set phase angle

IMMediate: the load starts input with 0 phase angle.

### Syntax:

OUTPut:ON:PHASe:MODE <CPD>

## Arguments

PHASe|IMMediate

## Query syntax:

INPut:ON:PHASe:MODE?

## Returns:

PHASe|IMMediate

## Example

OUTP:ON:PHAS:MODE IMM

## **INPut:ON:PHASe:LEVel <NRf+>**

The command sets the starting phase angle value when the instrument input is turned on.

## Syntax:

INPut:ON:PHASe:LEVel <NRf+>

## Arguments

MINimum|MAXimum

## Query syntax:

INPut:ON:PHASe:LEVel?

## Returns:

MINimum|MAXimum

## Example

INPut:ON:PHASe:LEVel 60

## **INPut:OFF:PHASe:MODE <CPD>**

The command sets the mode of phase control when the instrument input is turned off.

PHASe: The load stop input with the set phase angle

IMMediate: the load stop input with 0 phase angle.

## Syntax:

INPut:OFF:PHASe:MODE <CPD>

## Arguments

PHASe|IMMediate

## Query syntax:

INPut:OFF:PHASe:MODE?

Returns:

PHASe|IMMediate

Example

INPut:OFF:PHASe:MODE IMM

## **INPut:OFF:PHASe:LEVel <NRf+>**

This command is used to set the phase angle value when the instrument input is turned off.

Syntax:

INPut:OFF:PHASe:LEVel <NRf+>

Arguments

MINimum|MAXimum|DEFault

Query syntax:

INPut:OFF:PHASe:LEVel?

Returns:

MINimum|MAXimum

Example

INPut:OFF:PHASe:LEVel 90

## **INPut:BALance[:STATe] <Boolean>**

In the three-phase mode, it is used to set the state of the input balance mode. This command is only supported in three-phase mode.

Syntax:

INPut:BALance[:STATe] <Boolean>

Arguments

0|OFF|1|ON

Query syntax:

INPut:BALance[:STATe]?

Returns:

0|1

Example

INPut:BALance ON

## INPut:MONitor:PHASe <CPD>

This command is used to set the monitored phase of the input.

This command is only supported in three-phase mode.

### Syntax:

```
INPut:MONitor:PHASe <CPD>
```

### Arguments

```
A|B|C
```

### Returns:

```
0|1
```

### Example

```
INPut:MONitor:PHASe A
```

## INPut:MONitor:VOLTage:RATio <CPD>

This command is used to set the input voltage monitoring ratio.

### Syntax:

```
INPut:MONitor:VOLTage:RATio <CPD>
```

### Arguments

```
50|100
```

### Query syntax:

```
INPut:MONitor:VOLTage:RATio?
```

### Example

```
INPut:MONitor:VOLTage:RATio 100
```

## INPut|OUTPut:MONitor:VOLTage:OFFSet

This command is used to set and query the monitoring bias for the output voltage.

### Syntax:

```
INPut|OUTPut:MONitor:VOLTage:OFFSet
```

### Arguments:

```
NRf
```

### Query syntax:

```
INPut|OUTPut:MONitor:VOLTage:OFFSet?
```

### Example

```
INPut:MONitor:VOLTage: OFFSet 10
```

## **INPut:MONitor:CURRent:RATio <CPD>**

This command is used to set the current monitoring ratio of the input.

### Syntax:

INPut:MONitor:CURRent:RATio <CPD>

### Arguments

5.0|10.0

### Query syntax:

INPut:MONitor:CURRent:RATio?

### Example

INPut:MONitor:CURRent:RATio 5.0

## **NPut|OUTPut:MONitor:CURRent:OFFSet**

This command is used to set and query the monitoring bias for the output current.

### Syntax:

INPut|OUTPut:MONitor:CURRent:OFFSet

### Arguments:

NRf

### Query syntax:

INPut|OUTPut:MONitor:CURRent:OFFSet?

### Example

INPut:MONitor:CURRent:OFFSet 5.0

## **INPut|OUTPut:ALC[::STATe] <CPD>**

This command is used to set the ALC state.

### Syntax:

INPut|OUTPut:ALC[::STATe] <CPD>

### Arguments:

0|OFF|1|ON

### Query syntax:

INPut|OUTPut:ALC[::STATe]?

### Example

INPut:ALC 1

---

## Chapter33 ARB Subsystem (Load)

---

### LIST:STATe?

This command is used to query the running status of list, IDLE: stopped, WTG: waiting for trigger, ACTive: running

Syntax:

LIST:STATe?

Example

LIST:STAT?

### LIST:REPeat <NR1>

This command is used to set and query the number of cycles run by list.

Syntax:

LIST:REPeat <NR1>

Arguments

<NR1>  
MINimum|MAXimum|DEFault

\*RST

0

Query syntax:

LIST:REPeat?

Returns:

<NR1>

Example

LIST:REP 10

### LIST:TERMinate <CPD>

This command is used to set and query the way to end the list operation. There are three ways to end:

NORMal: after the list runs, it will automatically return to normal.

LAST: keep the output of the last step after the list runs.

OFF: turn off the output after the list operation is over and still in the list mode.

Syntax:

LIST:TERMinate <CPD>

## Arguments

<CPD>  
NORMal|LAST|OFF

## Query syntax:

LIST:TERMinate?

## Returns:

NORMal|LAST|OFF

## \*RST

OFF

## Example

LIST:TERM LAST

## LIST:RSTate?

This command is used to query the runtime information of List, in which loop the list is presently running, and at which step it is presently running.

Return value: <NR1>,<NR1> The first is the number of cycles presently running, and the second is the position of the present running step.

## Syntax:

LIST:RUNTime:STAtE?

## Returns:

<NR1>,<NR1>

## Example

LIST:RUNTime:STAtE?

## LIST:RECall <string>

This command is used to call back the saved list file and query the file name presently called.

## Syntax:

LIST:RECall <string>

## Query syntax:

LIST:RECall?

## Example

LIST:RCL "test.csv"

## LIST:STEP:COUNT?

This command is used to query the total number of steps in the list.

Syntax:

LIST:STEP:COUNT?

Returns:

<NR1>

Example

LIST:STEP:COUNT?

## LIST:CLEAr

This command is used to clear the list configuration.

Syntax:

LIST:CLEAr

Example

LIST:CLE

## LIST:STEP <NR1>,<string>

This command is used to configure and query the list step parameters.

<NR1>: step index

<string>: the parameters are separated by commas, and the specific order is as follows:

Three phase:

IAC_A	0
IAC_B	1
IAC_C	2
IAC_SLEW_A	3
IAC_SLEW_B	4
IAC_SLEW_C	5
IDC_A	6
IDC_B	7
IDC_C	8
IDC_SLEW_A	9
IDC_SLEW_B	10
IDC_SLEW_C	11
PHASE_MODE	12
START_A	13
START_B	14
START_C	15
R_A	16
R_B	17

R_C	18
R_A_SLEW	19
R_B_SLEW	20
R_C_SLEW	21
THREE_WAVE_A	22
THREE_WAVE_B	23
THREE_WAVE_C	24
THREE_TIME_MODE	25
THREE_TIME	26
THREE_TRIG_OUT	27
A_PHASE_SHIFT	29
B_PHASE_SHIFT	29
C_PHASE_SHIFT	30
A_wave_PARAM	31
B_WAVE_PARAM	32
C_WAVE_PARAM	33

Single mode/ Reverse mode:

IAC	0
IAC_SLEW	1
IDC	2
IDC_SLEW	3
PHASE_MODE	4
START_A	5
R	6
R_SLEW	7
WAVE	9
TIME_MODE	9
TIME	10
TRIG_OUT	11
PHASE_START	12
WAVE_PARM	13

Syntax:

LIST:STEP <NR1>,<string>

Query syntax:

LIST:STEP? <NR1>

Example

Three mode:

LIST:STEP

1, "11,11,11,11,11,11,11,5,5,5,6,6,6,PHASe,90,90,90,16,16,16,2,2,2,Sine,Sine,Sine, TIME,2,OFF,10,10,10,2,2,2"

Single mode or reverse mode:

LIST:STEP 1, "1,1,10,5,PHASe,90,0,0,Sine,TIME,1,OFF,10,2"

Note: The values set in this command include all parameters of CC and CR modes, but when returned, only the value displayed in the interface is returned.

## LIST:STEP:ITEM <NR1>,<NR1>,<NRf+>

This command is used to configure and query the phase parameters of a certain step in the list.

<NR1>: Step index , [1,100]

<NR1>:

IAC_A	0
IAC_B	1
IAC_C	2
IAC_SLEW_A	3
IAC_SLEW_B	4
IAC_SLEW_C	5
IDC_A	6
IDC_B	7
IDC_C	8
IDC_SLEW_A	9
IDC_SLEW_B	10
_SLEW_C	11
PHASE_MODE	12
START_A	13
START_B	14
START_C	15
R_A	16
R_B	17
R_C	18
R_A_SLEW	19
R_B_SLEW	20
R_C_SLEW	21
THREE_WAVE_A	22
THREE_WAVE_B	23
THREE_WAVE_C	24
THREE_TIME_MODE	25
THREE_TIME	26

THREE\_TRIG\_OUT 27  
A\_PHASE\_SHIFT 29  
B\_PHASE\_SHIFT 29  
C\_PHASE\_SHIFT 30  
A\_wave\_PARAM 31  
B\_WAVE\_PARAM 32  
C\_WAVE\_PARAM 33  
<NRf+>: setting value

**Syntax:**

LIST:STEP:ITEM <NR1>,<NR1>,<NRf+>

**Query syntax:**

LIST:STEP:ITEM? <NR1>,<item>

**Example**

LIST:STEP:ITEM 1,0,"100"  
LIST:STEP:ITEM 1,22,"Sine"

**LIST:STEP:ITEM? <NR1>,<item>**

This command is used to query the phase parameters of a certain step in the list.

**Syntax:**

LIST:STEP:ITEM? <NR1>,<item>

**Arguments**

<NR1>,<item>

**Returns:**

<NRf+>

**Example**

LIST:STEP:ITEM? 1,6

**LIST:NAME?**

This command is used to query the path name of the presently opened list file.

**Syntax:**

LIST:NAME?

**Example**

LIST:NAME?

## LIST:SAVe <filename>

This command is used to save the file to the /mnt/emm\_user/user\_data/sys/list/ directory. If the file name already exists, the present file will be overwritten, if it does not exist, it will be saved as a new file.

Syntax:

```
LIST:SAVe <filename>
```

Example

```
LIST:SAV "123.csv"
```

## LIST:CONFigure

This command is used to make the presently configured list parameters take effect.

Syntax:

```
LIST:CONFigure
```

Example

```
LIST:CONF
```

## LIST:CREate

This command is used to create a list.

Syntax:

```
LIST:CREate
```

Example

```
LIST:CRE
```

## LIST:FILE:NUMBer?

This command is used to query the number of list files under the present device type.

Syntax:

```
LIST:FILE:NUMBer?
```

Example

```
LIST:FILE:NUMB?
```

## LIST:FILE:NAME? <index>

This command is used to query the name of a list file according to the index.

Syntax:

```
LIST:FILE:NAME? <index>
```

## Arguments

<NR1>

## Example

```
LIST:FILE:NAME? 1
```

## **LIST:FILE:DELeTe <filename>**

This command is used to delete the list file.

## Syntax:

```
LIST:FILE:DELeTe <filename>
```

## Arguments

<CPD>

## Example

```
LIST:FILE:DEL "123.csv"
```

## **LIST:STEP:JUMP <NR1>**

The command sets the step number of the list loop jump, for Example, if it is set to 2, the list loop skips the previous two steps and starts from step 3.

NR1: The minimum value is 0, i.e., no skipped steps and all steps are looped; the maximum value is less than the total number of steps.

## Syntax:

```
LIST:STEP:JUMP <NR1>
```

## Arguments

<NR1>

## Query syntax:

```
LIST:STEP:JUMP? [MAXimum|MINimum]
```

## Returns:

<NRf+>

## Example

```
LIST:STEP:JUMP 2
```

## **LIST:FUNcTion <CPD>**

This command is used to set list running mode. Such as CC mode or CR mode.

## Syntax:

```
LIST:FUNcTion <CPD>
```

## Arguments

AC mode: CC|CR  
DC mode: CC|CR|CP

## Query syntax:

LIST:FUNcTion?

## Example

LIST:FUNcTion CC

## **LIST:DCCV:STATe <Boolean>**

This command is used to set CV state of DC list mode.

## Syntax:

LIST:DCCV:STATe <Boolean>

## Arguments

<0|1|OFF|ON>

## Query syntax:

LIST:DCCV:STATe?

## Example

LIST:DCCV:STAT 0

## **LIST:DCCV:VOLTage <NRf+>**

This command is used to set Voltage level of CV in DC List mode.

## Syntax:

LIST:DCCV:VOLTage <NRf+>

## Arguments

<NR1>

## Query syntax:

LIST:DCCV:VOLTage?

## Example

LIST:DCCV:VOLTage 40

## Chapter34 SURGesag Subsystem (Load)

### SURGesag:MODE <mode>

This command is used to set and query the surge/trap wave generating mode.

<mode>: surge/trap wave operating mode PERiod|TRIG.

PERiod generates surge/trap wave periodically, TRIG generates surge/trap wave when triggered.

#### Syntax:

SURGesag:MODE <mode>

#### Arguments

PERiod|TRIG

#### Query syntax:

SURGesag:MODE?

#### Returns:

PERiod|TRIG

#### Example

SURGesag:MODE PERiod //Set surge/trap wave generating mode to periodic mode.

SURGesag:MODE? //Query the surge/trap wave generating mode.

### SURGesag:PHASe:STARt <NRf+>

This command is used to set and query the initial phase of the surge/trap wave.

<NRf+>: start phase setting value, or start phase MINimum or MAXimum or DEFault setting.

#### Syntax:

SURGesag:PHASe:STARt <NRf+>

#### Arguments

<NRf+>

#### 单位

Degree (°)

#### \*RST

0

#### Query syntax:

SURGesag:PHASe:STARt? [MAXimum|MINimum|DEFault]

Returns:

<NRf+>

Example

```

SURGesag:PHASe:STARt 90 //Set the initial phase of the surge/trap wave
                           to 90°.
SURGesag:PHASe:STARt? //Query the presently set starting phase.
SURGesag:PHASe:STARt? MAX // Query the maximum value of the starting
                           phase.
    
```

## **SURGesag:PHASe:WIDTh <NRf+>**

This command is used to set and query the surge/trap wave angle width.

<NRf+>: angle width setting value

Syntax:

SURGesag:PHASe:WIDTh <NRf+>

Arguments

<NRf+>

单位

Degree (°)

\*RST

0

Query syntax:

SURGesag:PHASe:WIDTh? [MAXimum|MINimum|DEFAULT]

Returns:

<NRf+>

Example

```

SURGesag:PHASe:WIDTh 320.0 //Set the angular width to 320°.
SURGesag:PHASe:WIDTh? //Query the set value of angle width.
SURGesag:PHASe:WIDTh? MIN // Query the minimum value of the angle
                           width.
    
```

## **SURGesag:ACTion <action>**

This command is used to set and query the trigger action of the surge/trap wave.

<action>: trigger action setting mode IMMEDIATE|PHASe.

Syntax:

SURGesag:ACTion <action>

## Arguments

IMMediate|PHASe

## Query syntax:

SURGesag:ACTion?

## Returns:

IMMediate|PHASe

## Example

```
SURGesag:ACTion IMMEDIATE           //Set the present trigger action to
                                       IMMEDIATE.

SURGesag:ACTion?
```

## **SURGesag:SYMMetry <bool>**

This command is used to set and query the symmetry mode switch of the surge/trap wave.

## Syntax:

SURGesag:SYMMetry <bool>

## Arguments

0 | OFF | 1 | ON

## \*RST

OFF

## Query syntax:

SURGesag:SYMMetry?

## Returns:

0 | OFF | 1 | ON

## Example

```
SURGesag:SYMMetry 1           //Turn on symmetry mode.
SURGesag:SYMMetry?           //Query the switch status of symmetric mode.
```

## **SURGesag:REPeat:COUNT <NR1>**

This command is used to set and query the number of continuous surge/trap waves.

<NR1+>: set value of continuously generated surge/trap waves.

## Syntax:

SURGesag:REPeat:COUNT <NR1>

## Arguments

<NR1>

## \*RST

1

## Query syntax:

SURGesag:REPeat:COUNT?

## Returns:

<NR1>

## Example

```
SURGesag:REPeat:COUNT 5 //Set the number of continuous surge/trap waves to 5.
```

## **SURGesag:PERiod:COUNT <NR1>**

This command is used to set and query the period interval of the surge/trap wave occurrence.

<NR1+>: the period interval setting value of the surge/trap wave occurrence.

## Syntax:

SURGesag:PERiod:COUNT <NR1>

## Arguments

<NR1>

## \*RST

1

## Query syntax:

SURGesag:PERiod:COUNT?

## Returns:

<NR1>

## Example

```
SURGesag: PERiod:COUNT 5 //set the period interval of the surge/trap wave occurrence to 5.
```

## **SURGesag:VALue:SElect <mode>**

This command is used to set and query the setting mode of the surge/trap wave dropping value.

<mode>: the expression mode of the surge/trap wave dropping value  
PERCent|SETTing

**Syntax:**

```
SURGesag:VALue:SElect <mode>
```

**Arguments**

```
PERCent|SETTing
```

**Query syntax:**

```
SURGesag:VALue:SElect?
```

**Returns:**

```
PERCent|SETTing
```

**Example**

```
SURGesag:VALue:SElect PERcent //Set the mode of the drop value to
                                percent
SURGesag:VALue:SElect?
```

**SURGesag:VALue:PERCent <NRf+>**

This command is used to set and query the percentage of the drop value of the surge/trap wave.

<NRf+>: dropping percentage setting value.

**Syntax:**

```
SURGesag:VALue:PERCent <NRf+>
```

**Arguments**

```
<NRf+>
```

**\*RST**

```
0
```

**Query syntax:**

```
SURGesag:VALue:PERCent?
```

**Returns:**

```
<NRf+>
```

**Example**

```
SURGesag:VALue:PERCent 10 //Set the drop percentage to 10%
SURGesag:VALue:PERCent?
```

**SURGesag:VALue:SETTing <NRf+>**

This command is used to set and query the drop value of the trap wave.

<NRf+> drop set value

**Syntax:**

SURGesag:VALue:SETTing <NRf+>

**Arguments**

<NRf+>

**\*RST**

0

**Query syntax:**

SURGesag:VALue:SETTing? [MAXimum|MINimum]

**Returns:**

<NRf+>

**Example**

```
SURGesag:VALue:SETT 20           //Set the drop value to 20V
SURGesag:VALue:SETT?             //Query the set value of the drop value
SURGesag:VALue:SETT? MAX        //Query the maximum value of the drop set
                                value.
```

**SURGesag:CHAN:ENABLE <A|B|C|AB|AC|BC|ABC>**

This command is used to set and query the phase of the trap dip, and is only available in three-phase mode.

**Syntax:**

SURGesag:CHAN:ENABLE <A|B|C|AB|AC|BC|ABC>

**Arguments**

<A|B|C|AB|AC|BC|ABC>

**Query syntax:**

SURGesag:CHAN:ENABLE?

**Returns:**

<NRf+>

**Example**

```
SURGesag:PHASe:ENABLE ABC
```

**SURGesag:SAVE <string>**

This command is used to save this surge/sag file.

**Syntax:**

SURGesag:SAVE <string>

**Example**

```
SURGesag:SAVE "filename"
```

**SURGesag:RECall <string>**

This command is used to recall the surge/sag file.

**Syntax:**

```
SURGesag:RECall <string>
```

**Example**

```
SURGesag:RECall "filename"
```

**SURGesag:STATe?**

This command is used to query the running status of the surge/trap wave.

**Syntax:**

```
SURGesag:STATe?
```

**Example**

```
SURGesag:STATe? //Query the running status of the surge/trap wave.
```

## Chapter35 WAVEform Subsystem (Load)

### WAVEform[:IMMediate] <WAVEform>,[WAVEform],[WAVEform]

This command is used to set and query the waveform in Normal mode. For the waveform with parameters, the parameters are set to default values.

<wave>:

- Sine
- Square
- Saw
- Triangle
- Trapezoid
- Clipped-sine
- DST-01(30)
- Filename

Syntax:

WAVEform[:IMMediate] <WAVEform>,[WAVEform],[WAVEform]

Arguments

<"Sine"|"Square"|"Triangle"|"Saw"|"Trapezoid"|"Clipped-sine"|"DST-01(30)"|"filename">,

<"Sine"|"Square"|"Triangle"|"Saw"|"Trapezoid"|"Clipped-sine"|"DST-01(30)"|"filename">,

<"Sine"|"Square"|"Triangle"|"Saw"|"Trapezoid"|"Clipped-sine"|"DST-01(30)"|"filename">,

\*RST

Sine

Query syntax:

WAVEform?

Returns:

<string>

Example

WAVE "Sine" // Set the waveform to Sine.

WAVE "Sine","Saw","Square" // Set three channel waveforms separately,  
valid under three-phase unbalanced or multi-channel.

WAVE?

### PWAVEform[:IMMediate] <phase/chan>,<WAVEform>

This command is used to set and query the waveform of a phase in Normal mode. For waveforms with parameters, the parameters are set to default values.

<wave>:

- Sine
- Square
- Saw
- Triangle
- Trapezoid
- Clipped-sine
- DST-01(30)
- Filename

Syntax:

PWAVEform[:IMMEDIATE] <phase/chan>,<WAVEform>

Arguments

<A|B|C|CH1|CH2|CH3>,

<"Sine"|"Square"|"Triangle"|"Saw"|"Trapezoid"|"Clipped-sine"|"DST-01(30)"|"filename">

\*RST

Sine

Query syntax:

PWAVEform? <phase/chan>

Returns:

<string>

Example

```
PWAVE CH1,"Sine" // Set the channel 1 waveform of the current mode to Sine.
PWAVE A,"Sine" // Set the phase A waveform of the current mode to Sine.
PWAVE? A // Query the waveform of phase A.
PWAVE? CH1 // Query the waveform of channel 1.
```

### **WAVEform:EDIT:PARAMeter <phase/chan>,<percent1>**

This command is used to set and query the waveform parameters of a phase/channel (for Example, the percentage of clipping wave. For waveform types without parameters, this parameter is invalid).

Syntax:

WAVEform:EDIT:PARAMeter <phase/chan>,<percent1>

Arguments

<A|B|C|CH1|CH2|CH3>,<0-0.5>|<0-0.25>

**Query syntax:**

```
WAVEform:EDIT:PARAmeter? <phase/chan>
```

**Returns:**

```
<NRF>
```

**Example**

```
WAVE:EDIT:PAR 0.25,0.25,0.25
WAVE:EDIT:PAR?      // Query waveform parameters of all phases/channels.
WAVE:EDIT:PAR? A    //Query the waveform parameters of phase A.
WAVE:EDIT:PAR? CH1  // Query the waveform parameters of channel 1.
```

**WAVEform:EDIT:THD:CLEar**

This command is used to clear the edited memory data of the THD wave.

**Syntax:**

```
WAVEform:EDIT:THD:CLEar
```

**Example**

```
WAVE:EDIT:THD:CLE
```

**WAVEform:EDIT:THD:IMPort <filename>**

This command is used to import the existing THD wave file into the editing memory and query the name of the THD wave file imported from the external storage.

**Syntax:**

```
WAVEform:EDIT:THD:IMPort <filename>
```

**Arguments**

```
"filename"
```

**Query syntax:**

```
WAVEform:EDIT:THD:IMPort?
```

**Returns:**

```
<string>
```

**Example**

```
WAVE:EDIT:THD:IMP "Thd01.csv"
WAVE:EDIT:THD:IMP?
```

**WAVEform:EDIT:THD:FORMula <formula>**

This command is used to set and query the distortion factor calculation method of the edited THD wave.

**Syntax:**

WAVEform:EDIT:THD:FORMula <formula>

**Arguments**

<%F|%R>

**Query syntax:**

WAVEform:EDIT:THD:FORMula?

**Returns:**

<CPD>

**Example**

WAVE:EDIT:THD:FORM %F

WAVE:EDIT:THD:FORM?

**WAVEform:EDIT:THD:DATA <order>,<string>**

This command is used to set and query the THD value and phase parameter of a certain order of harmonics.

**Syntax:**

WAVEform:EDIT:THD:DATA <order>,<string>

**Arguments**

<2-50>,<"thd,phase">

**Query syntax:**

WAVEform:EDIT:THD:DATA? <order>

**Returns:**

<string>

**Example**

WAVE:EDIT:THD:DATA 2, "9.8,0.0"

WAVE:EDIT:THD:DATA? 2

**WAVEform:EDIT:THD:SAVE:LOCAL <filename>**

This command is used to save the presently edited THD wave data to a local file, and specify the file name (if the file name is the same, it is regarded as modifying the present waveform, if the file name does not exist, it is regarded as creating a new file)

**Syntax:**

WAVEform:EDIT:THD:SAVE:LOCAL <filename>

## Arguments

"filename"

## Example

```
WAVE:EDIT:THD:SAVE:LOC "THD01.csv"
```

## **WAVEform:EDIT:THD:SAVE:UDISk <filename>**

This command is used to save the presently edited THD wave data to a U disk file, and specify the file name (if the file name is the same, it is regarded as modifying the current waveform, if the file name does not exist, it is regarded as creating a new file)

## Syntax:

```
WAVEform:EDIT:THD:SAVE:UDISk <filename>
```

## Arguments

"filename"

## Example

```
WAVE:EDIT:THD:SAVE:UDIS "THD01.csv"
```

## **WAVEform:EDIT:USERdefine:CLEAr**

This command is used to clear all of userdefined waveform data.

## Syntax:

```
WAVEform:EDIT:USERdefine:CLEAr
```

## Example

```
WAVE:EDIT:USER:CLE
```

## **WAVEform:EDIT:USERdefine:IMPorT <filename>**

This command is used to import the data of the existing custom wave into the editing memory and query the file name of the imported userdefined wave.

## Syntax:

```
WAVEform:EDIT:USERdefine:IMPorT <filename>
```

## Arguments

"filename"

## Query syntax:

```
WAVEform:EDIT:USERdefine:IMPorT?
```

## Returns:

<string>

## Example

```
WAVE:EDIT:USER:IMP "USER01"  
WAVE:EDIT:USER:IMP?
```

## **WAVEform:EDIT:USERdefine:MODE <symmetry>**

This command is used to set and query the userdefined wave editing mode, where:

ASYM: The user can only edit the first 512 points, not symmetrical about the origin;

SYMM: The user can only edit the first 512 points, which are symmetrical about the origin;

FULL: users can customize and edit 1024 points in the entire cycle.

## Syntax:

```
WAVEform:EDIT:USERdefine:MODE <symmetry>
```

## Arguments

```
<ASYM,SYMM,FULL>
```

## Query syntax:

```
WAVEform:EDIT:USERdefine:MODE?
```

## Returns:

```
<ASYM,SYMM,FULL>
```

## Example

```
WAVE:EDIT:USER:MODE ASYM  
WAVE:EDIT:USER:MODE?
```

## **WAVEform:EDIT:USERdefine:DATA <index>,<normalization>**

Set and query the normalized point value of the point whose order is index.

## Syntax:

```
WAVEform:EDIT:USERdefine:DATA <index>,<normalization>
```

## Arguments

```
<0-1023>,<0.0-1.0> (Note: The range of index varies with the presently set  
waveform editing mode (symmetrical attribute), FULL is 0-1023, and other modes  
are 0-511)
```

## Query syntax:

```
WAVEform:EDIT:USERdefine:DATA? <index>
```

## Returns:

```
<NR2>
```

## Example

```
WAVE:EDIT:USER:DATA 1,0.5  
WAVE:EDIT:USER:DATA? 1
```

## **WAVEform:EDIT:USERdefine:SAVE:LOCal <filename>**

This command is used to save the presently edited custom wave data to a file, and specify the file name (if the file name is the same, it is regarded as modifying the current waveform, if the file name does not exist, it is regarded as creating a new file).

### Syntax:

```
WAVEform:EDIT:USERdefine:SAVE:LOCal <filename>
```

### Arguments

"filename"

### Example

```
WAVE:EDIT:USER:SAVE:LOC "USER01.csv"
```

## **WAVEform:EDIT:USERdefine:SAVE:UDISk <filename>**

This command is used to save the presently edited custom waveform data to a USB disk file, and specify the file name (if the file name is the same, it is regarded as modifying the current waveform, if the file name does not exist, it is regarded as creating a new file)

### Syntax:

```
WAVEform:EDIT:USERdefine:SAVE:UDISk <filename>
```

### Arguments

"filename"

### Example

```
WAVE:EDIT:USER:SAVE:UDIS "USER01.csv"
```

## Chapter36 SWEEp Subsystem (Load)

### SWEEp:FUNCTION <mode>

This command is used to set Sweep mode.

AC mode: CC|CR

DC mode: CC|CP|CR

#### Syntax:

SWEEp:FUNCTION <mode>

#### Arguments

CC|CR or CC|CP|CR

#### \*RST

0

#### Query syntax:

SWEEp:FUNCTION?

#### Returns:

CC|CP|CR

#### Example

SWEE:FUNC CC

### SWEEp:LEVEL:START <NRf+>[,<NRf+>,<NRf+>]

This command is used to set and query the start value of Sweep.

<NRf+>: initial setting value, or initial MINimum or MAXimum or DEFault setting

Note:

In single-phase (including AC, ACDC, DC, DCAC), there is only one parameter; in three-phase, three parameters must be taken.

#### Syntax:

SWEEp:LEVEL:START <NRf+>[,<NRf+>,<NRf+>]

#### Arguments

<NRf+>[,<NRf+>,<NRf+>]

#### \*RST

0

#### Query syntax:

SWEEp:LEVEL:START? [A|B|C][MAXimum|MINimum]

Returns:

<NR2>

Example

```
SWEep:LEVel:STARt 100           //Set the starting value of sweep to 100.
SWEep:LEVel:STARt?
```

## **SWEep:LEVel:STOP <NRf+>[,<NRf+>,<NRf+>]**

This command is used to set and query the stop value of sweep.

<NRf+>: stop setting value, or stop MINimum or MAXimum or DEFault setting.

Note:

In single-phase (including AC, ACDC, DC, DCAC), there is only one parameter; in three-phase, three parameters must be taken.

Syntax:

```
SWEep:LEVel:STOP <NRf+>[,<NRf+>,<NRf+>]
```

Arguments

<NRf+>[,<NRf+>,<NRf+>]

Query syntax:

```
SWEep:LEVel:STOP? [A|B|C][MAXimum|MINimum]
```

Returns:

<NR2>

Example

```
SWEep:LEVel:STOP 90           // Set the stopping value of sweep to 100.
```

## **SWEep:LEVel:STEP <NRf+>[,<NRf+>,<NRf+>]**

This command is used to set and query the step level of sweep.

<NRf+>: step setting value, or step MINimum or MAXimum or DEFault setting.

Note:

In single-phase (including AC, ACDC, DC, DCAC), there is only one parameter; in three-phase, three parameters must be taken.

Syntax:

```
SWEep:LEVel:STEP <NRf+>[,<NRf+>,<NRf+>]
```

Arguments

<NRf+>[,<NRf+>,<NRf+>]

Query syntax:

```
SWEep:LEVel:STEP? [A|B|C][MAXimum|MINimum]
```

Returns:

<NR2>

Example

```
SWEEp:LEVel:STEP 1           //set the step value to 1
SWEEp:LEVel:STEP?
```

## SWEEp:TIME:STEP <NRf+>

This command is used to set and query the single-step execution time of sweep. It is valid when the mode is TIME.

<NRf+>: step time setting value, or step time MINimum or MAXimum or DEFault setting.

Note:

In single-phase (including AC, ACDC, DC, DCAC), there is only one parameter; in three-phase, three parameters must be taken.

Syntax:

SWEEp:TIME:STEP <NRf+>

Arguments

<NRf+>

Query syntax:

SWEEp:TIME:STEP? [MAXimum|MINimum]

Returns:

<NR1>

Example

```
SWEEp:TIME:STEP 1
SWEEp:TIME:STEP?
```

## SWEEp:MODE <mode>

This command is used to set and query the switching mode between the single steps of the sweep function, and it can be set to TIME or TRIG mode.

<mode> TIME|TRIG|TIME\_LOOP|TRIG\_LOOP

TIME\_LOOP: Time loop sweep

TRIG\_LOOP: trigger loop sweep

Syntax:

SWEEp:FREQ:STOP <NRf+>[,<NRf+>,<NRf+>]

Arguments

<NRf+>[,<NRf+>,<NRf+>]



Returns:

<NRf+>

Example

SWEep:WAVeform:PAR 1.414

## **SWEep:PSHift <NRf+>**

This command is used to set the phase shift between voltage and current.

Syntax:

SWEep:PSHift <NRf+>

Arguments

TIME|TRIG

\*RST

TIME

Query syntax:

SWEep:PSHift?

Returns:

TIME|TRIG

Example

SWEep:MODE TIME

## **SWEep:TERMinate <mode>**

This command is used to set and query the end status of sweep.

<type>: sweep wave type NORMal|LAST|OFF

Syntax:

SWEep:TERMinate <mode>

Arguments

NORMal|LAST|OFF

Query syntax:

SWEep:TERMinate?

Returns:

NORMal|LAST|OFF

Example

SWEep:TERMinate OFF

## **SWEep:TRIG:SOURce <mode>**

This command is used to set the trigger source of Sweep function.

### Syntax:

SWEep:TRIG:SOURce <mode>

### Arguments

MANual|BUS|TRIG1|TRIG2

### \*RST

MANual

### Query syntax:

SWEep:TRIG:SOURce?

### Returns:

MANual|BUS|TRIG1|TRIG2

### Example

SWEep:TRIG:SOURce MANual

## **SWEep:STEP:REPeat <NR1>**

Set the number of sweep repetitions, set 0 for infinite loop.

### Syntax:

SWEep:STEP:REPeat <NR1>

### Arguments

1-65535

### Query syntax:

SWEep:STEP:REPeat? [MAXimum|MINimum]

### Example

SWEep:STEP:REPeat <NR1>

## Chapter37 IEEE-488 Common Commands

IEEE-488 Common commands usually control all instrument functions, such as reset, status, and synchronization. All common commands consist of a three-letter mnemonic, and are preceded by an asterisk, E.g: \*RST \*IDN? \*SRE 8.

### \*CLS

This command clears the error queue and the bits of the following registers:

- Standard Event Register
- Questionable Event Register
- Status byte register

#### Syntax:

\*CLS

#### Arguments:

None

### \*ESE

This command sets the bits in the Event Status Enable Register (ESER). The ESER is an eight-bit register that determines which bits in the Standard Event Status Register (SESR) will set the Event Summary Bit (ESB) in the Status Byte Register (SBR).

#### Syntax

\*ESE <NR1>

#### Arguments

0~255

#### Default value

0

#### Example

\*ESE 128

#### Query syntax

\*ESE?

#### Returns

<NR1>

#### Related syntax

\*ESR? \*PSC \*STB?

Bit definition of standard event enable register:

Bit	7	6	5	4	3	2	1	0
Name	PON	n.u	CME	EXE	DDE	QYE	n.u	OPC
Value Bit Weight	128		32	16	8	4		1

## \*ESE?

This command queries the bits in the Event Status Enable Register (ESER).

### Query syntax

\*ESE?

### Arguments

None

### Returns

<NR1> This is a decimal value with a binary weighted sum.

## \*ESR?

This command reads the value of Standard Event Status Register (SESR). Once this command executes, the SESR is reset. The bit definition for the SESR is the same as the Standard Event Status Enable Register.

### Query syntax

\*ESR?

### Arguments

None

### Returns

<NR1> This is a decimal value with a binary weighted sum.

### Related syntax

\*CLS \*ESE \*ESE? \*OPC

## \*IDN?

This command reads information that identifies the electronic load. It returns a parameter that contains four segments divided by a comma.

### Query syntax

\*IDN?

### Arguments

None

### Returns

Manufacture, model, serial number, UI ver-DSP1 ver-DSP2 ver-PFC ver-Interface

ver

### Example

```
Itech\sElectronics,IT8215-350-90,804947011767740001,  
000.001.038,83.R,13.R\n
```

## \*OPC

This command sets the Operation Complete (OPC) bit in the Standard Event Status Register to 1 when all other commands are complete.

### Syntax

\*OPC

### Arguments

None

### Query syntax

\*OPC?

### Returns

<NR1>

## \*RST

This command resets the electronic load to default settings.

### Syntax

\*RST

### Arguments

None

## \*SRE <NR1>

This command sets or queries the bits in the Status Byte Enable Register. Setting this parameter can determine which byte of the Status Byte Register has a value of 1. The byte sets the RQS bit of the Status Byte Register to 1. The bit definition of the Status Byte Enable Register is as the same as the Status Byte Register.

### Syntax

\*SRE <NR1>

### Arguments

0~255

### Default value

Refer to \*PSC command

## Example

\*SRE 128

## Query syntax

\*SRE?

## Returns

<NR1>

## Related syntax

\*ESE \*ESR? \*PSC \*STB?

## \*STB?

This command reads the data in the Status Byte Register (SBR).

## Query syntax

\*STB?

## Arguments

None

## Returns

<NR1>

## Related syntax

\*CLS \*ESE \*ESR

Bit definition of the Status Byte Register:

Bit	7	6	5	4	3	2	1	0
Name	OPER	RQS	ESB	MAV	QUES	EAV	n.u	n.u
Value Bit Weight	128	64	32	16	8	4		

## \*PSC

This instruction is used to control whether the status register is cleared when the instrument is powered-on. This instruction affects the value of the status register at the next powered-on.

## Syntax

\*PSC <ON|1|OFF|0>

## Arguments

0|1|ON|OFF

## Query syntax

\*PSC?

**Returns**

&lt;ON|1|OFF|0&gt;

**\*SAV**

This command saves the present setting values of the electronic load into specified memory.

**Syntax**

\*SAV &lt;NR1&gt;

**Arguments**

0~9

**\*RCL**

This command recalls the setups you saved in the specified memory location.

**Syntax**

\*RCL &lt;NR1&gt;

**Arguments**

0~9

## Contact US

Thank you for purchasing ITECH products. If you have any doubt about this product, please contact us as follow.

1. Visit ITECH website [www.itechate.com](http://www.itechate.com) .
2. Select the most convenient contact for further consultation.