

Programmable DC Electronic Load

IT8400 Series User Manual



Model: IT8400 Series
Version: V1.4/4,2025

Notices

© Itech Electronic, Co., Ltd. 2025

No part of this manual may be reproduced in any form or by any means (including electronic storage and retrieval or translation into a foreign language) without prior permission and written consent from Itech Electronic, Co., Ltd. as governed by international copyright laws.

Manual Part Number



402225

Trademarks

Pentium is U.S. registered trademarks of Intel Corporation.

Microsoft, Visual Studio, Windows and MS Windows are registered trademarks of Microsoft Corporation in the United States and/or other countries and regions.

Warranty

The materials contained in this document are provided “as is”, and is subject to change, without prior notice, in future editions. Further, to the maximum extent permitted by applicable laws, ITECH disclaims all warrants, either express or implied, with regard to this manual and any information contained herein, including but not limited to the implied warranties of merchantability and fitness for a particular purpose. ITECH shall not be held liable for errors or for incidental or indirect damages in connection with the furnishing, use or application of this document or of any information contained herein. Should ITECH and the user enter into a separate written agreement with warranty terms covering the materials in this document that conflict with these terms, the warranty terms in the separate agreement shall prevail.

Technology Licenses

The hardware and/or software described herein are furnished under a license and may be used or copied only in accordance with the terms of such license.

Restricted Rights Legend

Restricted permissions of the U.S. government. Permissions for software and technical data which are authorized to the U.S. Government only include those for custom provision to end users. ITECH follows FAR 12.211 (technical data), 12.212 (computer software). DFARS 252.227-7015 (technical data—commercial products) and DFARS 227.7202-3 (permissions for commercial computer software or computer software documents) while providing the customized business licenses of software and technical data.

Safety Notices

CAUTION

A CAUTION sign denotes a hazard. It calls attention to an operating procedure or practice that, if not correctly performed or adhered to, could result in damage to the product or loss of important data. Do not proceed beyond a CAUTION sign until the indicated conditions are fully understood and met.

WARNING

A WARNING sign denotes a hazard. It calls attention to an operating procedure or practice that, if not correctly performed or adhered to, could result in personal injury or death. Do not proceed beyond a WARNING sign until the indicated conditions are fully understood and met.



Note

A NOTE sign denotes important hint. It calls attention to tips or supplementary information that is essential for users to refer to.

Quality Certification and Assurance

We certify that series instrument meets all the published specifications at time of shipment from the factory.

Warranty

ITECH warrants that the product will be free from defects in material and workmanship under normal use for a period of one (1) year from the date of delivery (except those described in the Limitation of Warranty below).



Note

Visit <https://www.itechate.com/en/support/register.html> to complete product registration by filling out the necessary information to extend the warranty to two (2) years.

For warranty service or repair, the product must be returned to a service center designated by ITECH.















- The product returned to ITECH for warranty service must be shipped PRE-PAID. And ITECH will pay for return of the product to customer.
- If the product is returned to ITECH for warranty service from overseas, all the freights, duties and other taxes shall be on the account of customer.

Limitation of Warranty

This Warranty will be rendered invalid in case of the following:

- Damage caused by circuit installed by customer or using customer own products or accessories;
- Modified or repaired by customer without authorization;
- Damage caused by circuit installed by customer or not operating our products under designated environment;
- The product model or serial number is altered, deleted, removed or made illegible by customer;
- Damaged as a result of accidents, including but not limited to lightning, moisture, fire, improper use or negligence.

Safety Symbols

	Direct current		ON (power)
	Alternating current		OFF (power)
	Both direct and alternating current		Power-on state
	Chassis (earth ground) symbol.		Power-off state
	Earth (ground) terminal		Reference terminal
	Caution		Positive terminal
	Warning (refer to this manual for specific Warning or Caution information)		Negative terminal
	A chassis terminal	-	-

Safety Precautions

The following safety precautions must be observed during all phases of operation of this instrument. Failure to comply with these precautions or specific warnings elsewhere in this manual will constitute a default under safety standards of design, manufacture and intended use of the instrument. ITECH assumes no liability for the customer's failure to comply with these precautions.

WARNING

- **Do not use the instrument if it is damaged. Before operation, check the casing to see whether it cracks. Do not operate the instrument in the presence of inflammable gasses, vapors or dusts.**
 - **The instrument is provided with a power cord during delivery and should be connected to a socket with a protective earth terminal, a junction box or a three-phase distribution box. Before operation, be sure that the instrument is well grounded.**
 - **Please always use the provided cable to connect the instrument.**
 - **Check all marks on the instrument before connecting the instrument to power supply.**
 - **Ensure the voltage fluctuation of mains supply is less than 10% of the working voltage range in order to reduce risks of fire and electric shock.**
 - **Do not install alternative parts on the instrument or perform any unauthorized modification.**
 - **Do not use the instrument if the detachable cover is removed or loosen.**
 - **To prevent the possibility of accidental injuries, be sure to use the power adapter supplied by the manufacturer only.**
 - **We do not accept responsibility for any direct or indirect financial damage or loss of profit that might occur when using the instrument.**
 - **This instrument is used for industrial purposes, do not apply this product to IT power supply system.**
 - **Never use the instrument with a life-support system or any other equipment subject to safety requirements.**
-

WARNING

- **SHOCK HAZARD Ground the Instrument.** This product is provided with a protective earth terminal. To minimize shock hazard, the instrument must be connected to the AC mains through a grounded power cable, with the ground wire firmly connected to an electrical ground (safety ground) at the power outlet or distribution box. Any interruption of the protective (grounding) conductor or disconnection of the protective earth terminal will cause a potential shock hazard that could result in injury or death.
 - **Before applying power, verify that all safety precautions are taken.** All connections must be made with the instrument turned off, and must be performed by qualified personnel who are aware of the hazards involved. Improper actions can cause fatal injury as well as equipment damage.
 - **SHOCK HAZARD, LETHAL VOLTAGES** This product can input the dangerous voltage that can cause personal injury, and the operator must always be protected from electric shock. Ensure that the input electrodes are either insulated or covered using the safety covers provided, so that no accidental contact with lethal voltages can occur.
 - **Never touch cables or connections immediately after turning off the instrument.** Verify that there is no dangerous voltage on the electrodes or sense terminals before touching them.
 - **After using the device, turn off the power switch of the device before unplugging the power cord or disassembling the terminals.** Do not touch the cable or the terminal immediately. Depending on the model, the dangerous voltage at the plug or terminal is maintained for 10 seconds after the device is switched off. Make sure that there is no dangerous voltage before touching them.
-

CAUTION

- **Failure to use the instrument as directed by the manufacturer may render its protective features void.**
 - **Always clean the casing with a dry cloth. Do not clean the internals.**
 - **Make sure the vent hole is always unblocked.**
-

Environmental Conditions





The instrument is designed for indoor use and an area with low condensation. The table below shows the general environmental requirements for the instrument.

Environmental Conditions	Requirements
Operating temperature	0°C ~ 40°C
Operating humidity	20% ~ 80%(non-condensation)
Storage temperature	-10°C ~ 70 °C
Altitude	Operating up to 2,000 meters
Installation category	II
Pollution degree	Pollution degree 2



Note

In order to ensure the accuracy of measurement, it is recommended to operate the instrument half an hour after start-up.

Regulation Tag

	The CE tag shows that the product complies with the provisions of all relevant European laws (if the year is shown, it indicates that the year when the design is approved).
	The UKCA tag shows that the product complies with the provisions of all relevant United Kingdom laws (if the year is shown, it indicates that the year when the design is approved).
	This instrument complies with the WEEE directive (2002/96/EC) tag requirements. This attached product tag shows that the electrical/electronic product cannot be discarded in household waste.
	This symbol indicates that no danger will happen or toxic substances will not leak or cause damage in normal use within the specified period. The service life of the product is 10 years. The product can be used safely within the environmental protection period; otherwise, the product should be put into the recycling system.

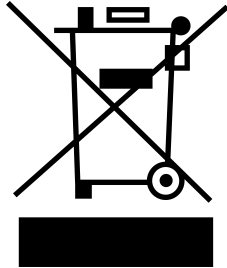
Waste Electrical and Electronic Equipment (WEEE) Directive



Waste electrical and electronic equipment (WEEE) directive, 2002/96/EC

The product complies with tag requirements of the WEEE directive (2002/96/EC). This tag indicates that the electronic equipment cannot be disposed of as ordinary household waste. Product Category

According to the equipment classification in Annex I of the WEEE directive, this instrument belongs to the "Monitoring" product.

If you want to return the unnecessary instrument, please contact the nearest sales office of ITECH.



Compliance Information

Complies with the essential requirements of the following applicable European Directives, and carries the CE marking accordingly:

- Electromagnetic Compatibility (EMC) Directive 2014/30/EU
- Low-Voltage Directive (Safety) 2014/35/EU

Conforms with the following product standards:

EMC Standard

IEC 61326-1 / EN 61326-1 ¹²³

Reference Standards

CISPR 11, Class A

IEC 61000-3-2

IEC 61000-3-3

IEC 61000-4-2

IEC 61000-4-3

IEC 61000-4-4

IEC 61000-4-5

IEC 61000-4-6

IEC 61000-4-11

1. The product is intended for use in non-residential/non-domestic environments. Use of the product in residential/domestic environments may cause electromagnetic interference.
2. Connection of the instrument to a test object may produce radiations beyond the specified limit.
3. Use high-performance shielded interface cable to ensure conformity with the EMC standards listed above.

Safety Standard

IEC 61010-1:2010+A1:2016



Note

This section provides general and universal terms. For more detailed information on the *Declaration of Conformity*, please contact ITECH personnel.

Content

Quality Certification and Assurance	I
Warranty	I
Limitation of Warranty	I
Safety Symbols	II
Safety Precautions.....	II
Environmental Conditions.....	IV
Regulation Tag	V
Waste Electrical and Electronic Equipment (WEEE) Directive	VI
 Compliance Information	VII
1 Inspection and Installation.....	1
1.1 Unpacking and Transportation.....	1
1.2 Verifying the Shipment.....	3
1.3 Instrument Size Introduction	4
1.4 Connecting the Power Cord.....	9
1.5 Connecting the DUT	12
2 Quick Reference.....	17
2.1 Brief Introduction.....	17
2.2 Front Panel Introduction.....	19
2.3 Keyboard Introduction.....	20
2.4 Fast Function Key	21
2.5 Function Description of VFD Status Indicators.....	22
2.6 Rear Panel Introduction	23
2.7 Power-on Selftest.....	26
3 Function and Features	29
3.1 Switching of Local/Remote Operation Modes	29
3.2 Constant-status Operation Mode.....	30
3.2.1 Constant Current Operation Mode (CC)	30
3.2.2 Constant Voltage Operation Mode (CV)	31
3.2.3 Constant Resistance Operation Mode (CR)	32
3.2.4 Constant Power Operation Mode (CW)	33
3.2.5 Compound Operation Mode	34
3.3 Input Control Function.....	35
3.4 Keyboard Locking Function	36
3.5 Short-circuit Analog Function.....	36
3.6 System Menu Function(System)	36
3.6.1 Restored to Factory Setting(Initialize).....	38
3.6.2 Power On Parameter(Power-On).....	38
3.6.3 Key Sound Set(Buzzer).....	38
3.6.4 Rotary Knob Set(Knob)	38
3.6.5 Trigge Mode(Trigger).....	39
3.6.6 Set Memory Group(Memory>Group)	39
3.6.7 Loading Time Display Set(Displ).....	39
3.6.8 Communication Set	40
3.7 Configuration menu function (Config).....	40
3.7.1 On-Timer Set(Protect>Time).....	42
3.7.2 Auto-Switching Voltage Range Set(Measure>V-Range).....	42
3.7.3 Setting Filter(Measure>Filter).....	43
3.7.4 Set transient over power loading capability(Enhance Power)	43
3.8 Triggering Function	44
3.9 Dynamic Test Function	45
3.9.1 Continuous Mode	45
3.9.2 Pulse Mode.....	47

3.9.3	Toggle Mode.....	48
3.10	OCP Test Function	50
3.11	OPP Test Function.....	51
3.12	Battery discharge test function	52
3.13	CR-LED test function	54
3.14	Measure Function	57
3.15	Configuration Save Function	58
3.16	VON Function	59
3.17	Protective Function	61
3.17.1	Overvoltage Protection (OVP).....	61
3.17.2	Overcurrent Protection (OCP).....	62
3.17.3	Overpower Protection (OPP).....	62
3.17.4	Overtemperature Protection (OTP).....	63
3.17.5	Current Oscillation Protection(OSC).....	63
3.18	List Operation.....	64
3.19	Terminal Function of Rear Panel	66
3.19.1	External Trigger Function	67
3.19.2	External On/Off Control	67
3.19.3	Voltage Fault Indication	68
3.19.4	External Analog Function	68
3.19.5	Current Monitoring (I Monitor)	68
3.20	Auto Test Function.....	69
3.21	Parallel Function	74
3.21.1	Parallel Operation(multi-masters)	74
3.21.2	Parallel Operation(one master and multi-slaves).....	78
4	Technical Specification	81
4.1	Main specifications.....	81
4.1.1	IT8406-600-150	81
4.1.2	IT8412-600-300	83
4.1.3	IT8418-600-450	85
4.1.4	IT8424-600-600	87
4.1.5	IT8430-600-750	89
4.1.6	IT8436-600-900	91
4.1.7	IT8442-600-1050	93
4.1.8	IT8448-600-1200	95
4.1.9	IT8454-600-1350	97
4.1.10	IT8406-1200-75	100
4.1.11	IT8412-1200-150	102
4.1.12	IT8418-1200-225	104
4.1.13	IT8424-1200-300	106
4.1.14	IT8430-1200-375	108
4.1.15	IT8436-1200-450	110
4.1.16	IT8442-1200-525	112
4.1.17	IT8454-1200-675	114
4.2	Additional features	116
5	References of Load Communication Interfaces.....	117
5.1	RS-232 interface	117
5.2	USB interface	119
5.3	GPIB interface.....	119
5.4	LAN Interface	120
5.4.1	Using Web Server.....	121
5.4.2	Using Sockets.....	122
A	Appendix	123
A.1	Specifications of Red and Black Test Cables	123
A.2	Fuse Replacement	124

1 Inspection and Installation

- ◆ Unpacking and Transportation
- ◆ Verifying the Shipment
- ◆ Instrument Size Introduction
- ◆ Connecting the Power Cord
- ◆ Connecting the DUT

1.1 Unpacking and Transportation

Unpacking

For cabinet products, they are packaged in wooden boxes at the factory. After you receive them, please refer to the unpacking instructions provided with the box for disassembly; for products packaged in cartons, please use appropriate tools for unpacking.

It is recommended to keep the complete transport packaging for the lifetime of the device for relocation or return to the manufacture for repair.

Transportation

If you need to transport non-cabinet products, you must pay attention to the following to ensure the safety of equipment and personnel.

CAUTION

- **Before moving, make sure that the cabinet or stand where the equipment will be placed has been fixed and meets the load-bearing conditions to avoid tilting and collapsing, causing personnel to be injured, and equipment broken.**
- **Due to the weight of the product, transport by hand should be avoided where possible. If unavoidable, carry it with two people and holding the product shell and not external parts (such as handles, electrodes, knobs, etc.).**
- **When carrying, be prepared to bear the weight to avoid sprains or being crushed by heavy objects.**
- **Use suitable safety clothing, especially safety shoes, when carrying the equipment, as due to its weight a fall can have serious consequences.**

After unpacking the cabinet product, if you need to move it to other places, you must pay attention to the following matters to ensure the safety of equipment and personnel.

CAUTION

- **The cabinet product is very heavy. Before moving to another location, confirm whether the ground load is in compliance.**
 - **During the process of moving the cabinet, it is recommended that two or more people cooperate and push it slowly and at a constant speed. If you encounter a pit, you need to pay special attention. It is forbidden to push it quickly, otherwise it will easily cause excessive inertia and cause the casters at the bottom of the cabinet to jam and the cabinet to fall.**
 - **It is not advisable to push down the slope to prevent the cabinet from falling down due to the shift of the center of gravity. It is recommended to use a forklift or crane to move the cabinet.**
 - **ITECH 27U and 37U cabinets are equipped with hoisting rings as standard on the top. It is recommended to use a crane equipped with a four-leg hoisting belt structure for horizontal hoisting and moving, and ensure that the four hoisting belts are the same length to avoid cabinet skew during movement. As shown below.**
 - **After moving to the destination, please lock the four casters to secure the cabinet.**
 - **The cabinet should be placed on a level ground. It is forbidden to place the cabinet on a sloped ground.**
-

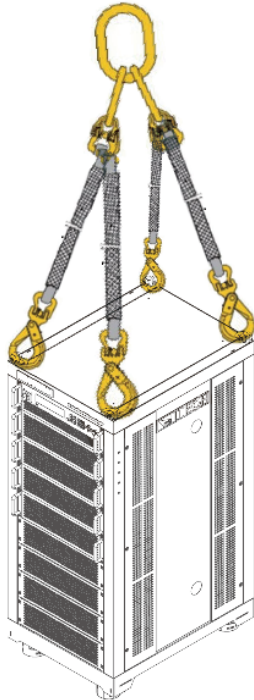

1.2 Verifying the Shipment

Open the package and check the articles within package box before operation. In case of any non-conformity, missing or appearance wearing, please contact ITECH immediately.

Table 1–1 Package box contents (to a machine as a reference standard)

Device name	Quantity	Model	Remarks
Electronic load	1	IT8400 series	Please refer to 2.1 Brief Introduction for complete models of this series electronic loads.
Power cord	1	IT-E171/IT-E172/ IT-E173/ IT-E174	User may select an appropriate power cord that matches the specifications of power socket used in the area. See the section Categories of power cords for details.
Red and black test lines	a set	-	The load whose power is greater than or equal to 10KW in this series are standard equipped with a set of

Device name	Quantity	Model	Remarks
			red and black test line, the test line specification is 95mm ² / 3m.
Calibration Report	1	-	Test report before delivery.
USB communication cable	1	-	This accessory is selected when the USB interface is used for starting up remote operation.
LAN communication cable	1	-	This accessory is selected when the LAN interface is used for starting up remote operation.



Note

After confirming that package contents are consistent and correct, please appropriately keep package box and related contents. The package requirements should be met when the instrument is returned to factory for repair.

1.3 Instrument Size Introduction

The instrument should be installed at well-ventilated and rational-sized space. Please select appropriate space for installation based on the electronic load size.

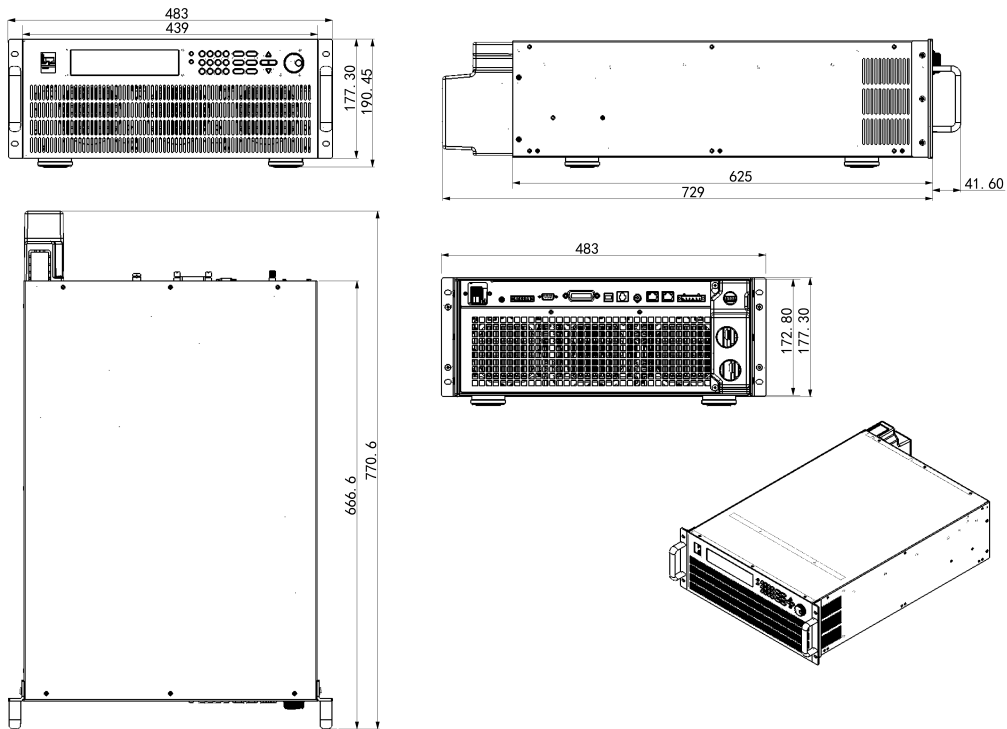
4U Model



8U Model

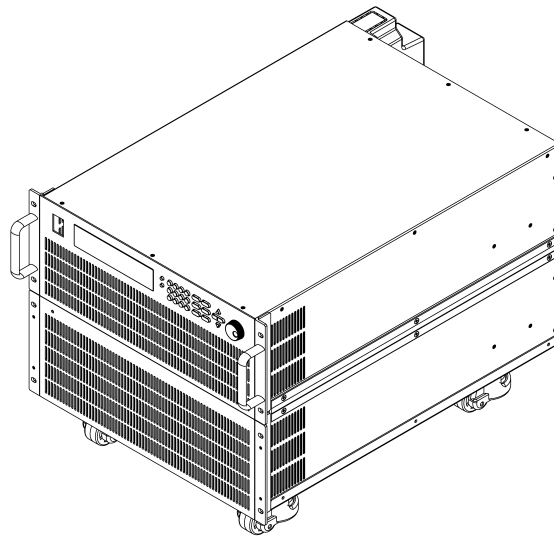
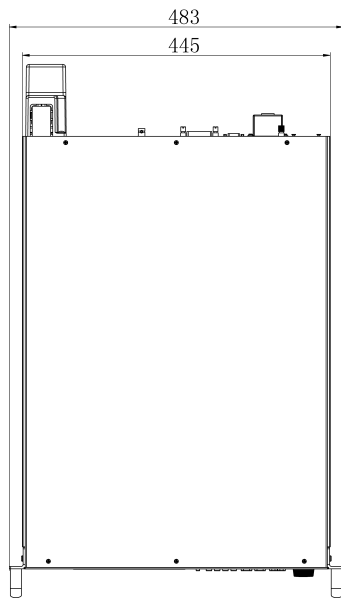
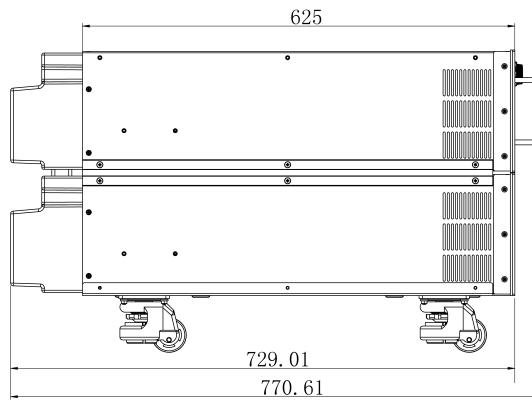
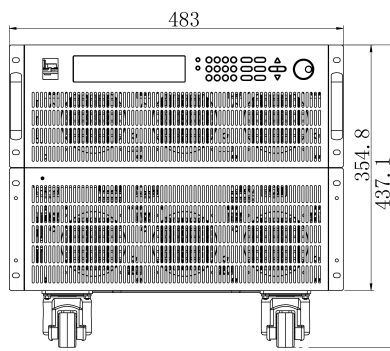

15U Model

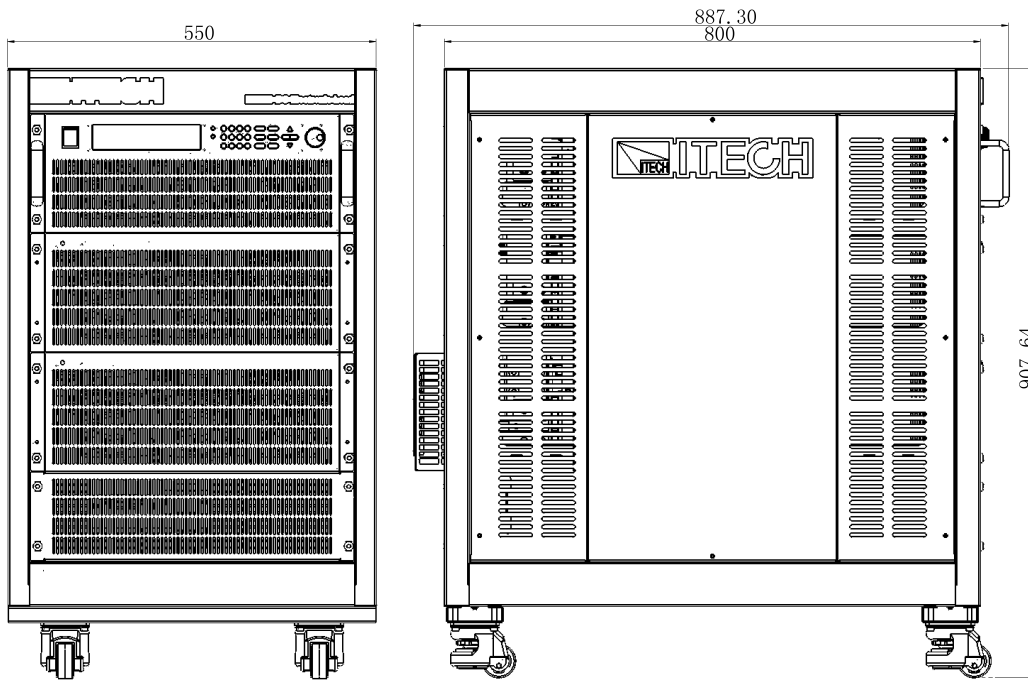

27U Model

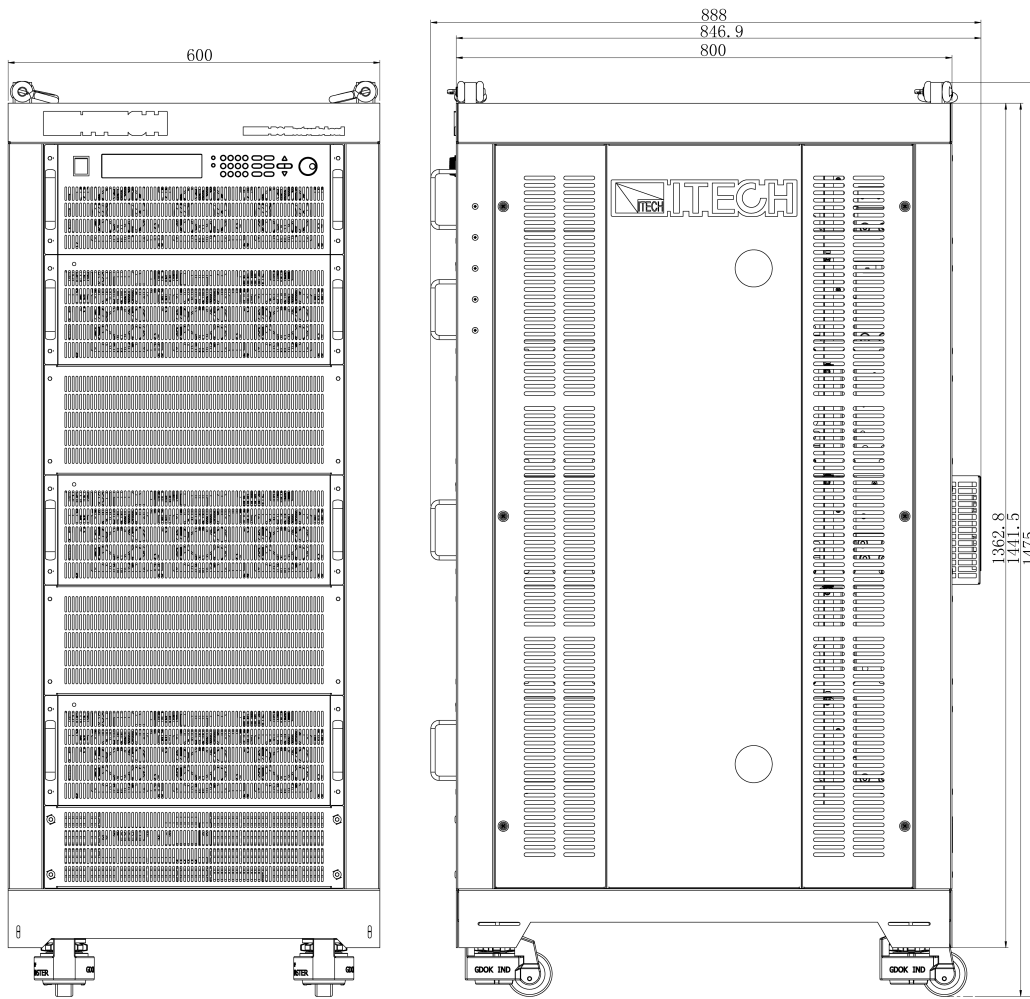

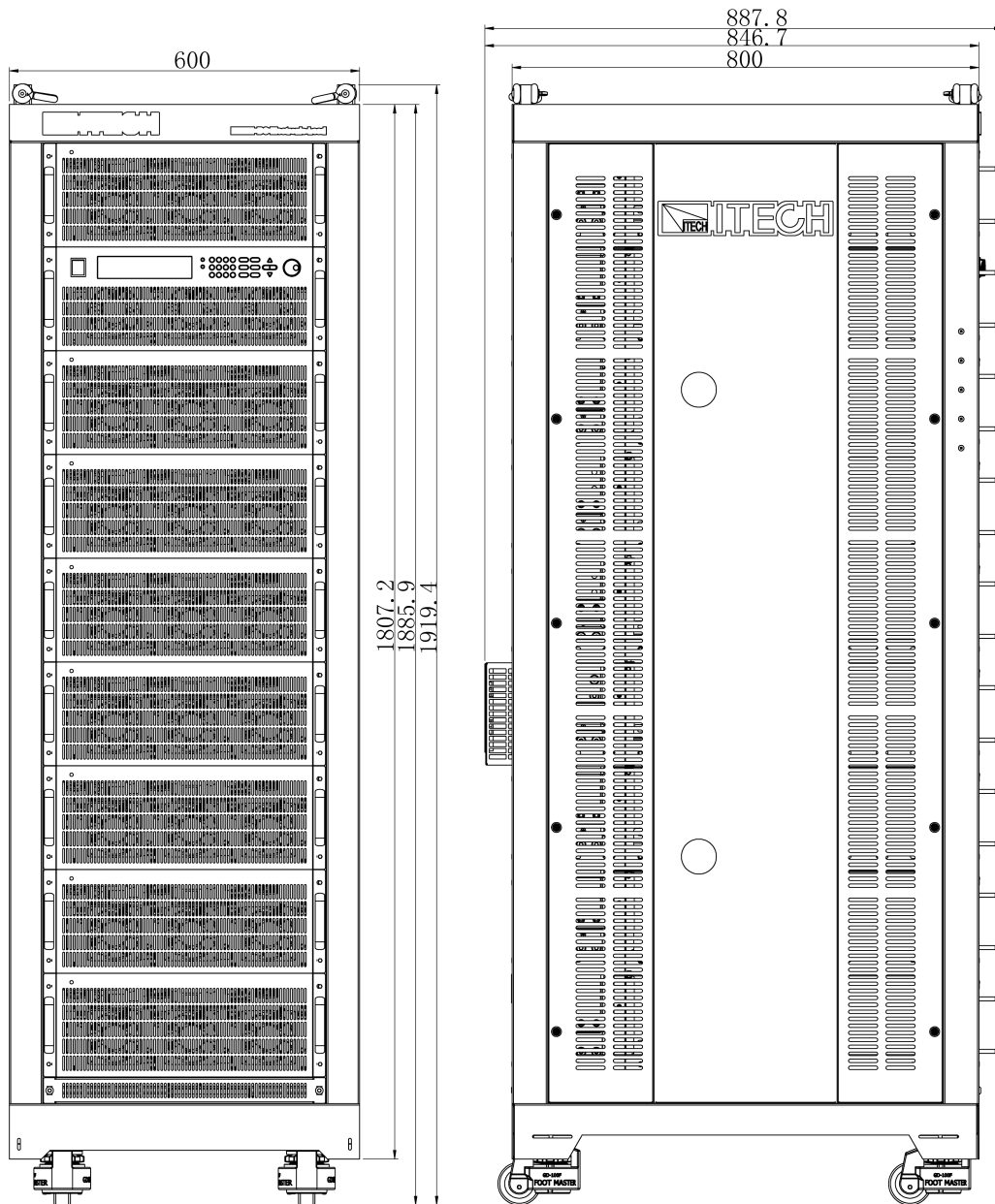
37U Model

1.4 Connecting the Power Cord

Before connect

To avoid burning out and electric shock, The safety precautions must be observed.

WARNING

- To avoid burning out, be sure to confirm that the power voltage matches with the supply voltage.
- If the working voltage of the instrument supports 110V or 220V, before connecting the power cord, please confirm the 110V / 220V transfer switch to ensure that the switch of the load matches the supply voltage. Otherwise, the instrument may be damaged.
- Please ensure the power switch of the instrument is turned Off.
- To avoid burning out and electric shock, please only use the power cord supplied as a standard accessory.
- Be sure to connect the main power socket to the power outlet with protective grounding. Do not use terminal board without protective grounding.
- To prevent electric shock, be sure to take protective earthing. Please connect the power cable to the socket with the protective earth terminal.
- Do not use an extended power cord without protective grounding, otherwise the protection function will fail.
- Please use the AC power socket matching the power cord shipped with the box and take the protective earthing measures. If you can not use a suitable AC power cord, do not use the instrument.

AC power input level

Working voltage for this series electronic load is 100V~240V, AC power input level: 100V~240V 50Hz/60Hz

Power Cord Type and Connecting Method

- 4U and 8U models provides the standard power cords as below. Please select appropriate power cords appropriate to local voltage based on the specifications of power cords below. If purchased model fails to meet local voltage requirements, please contact distributor or factory for change.

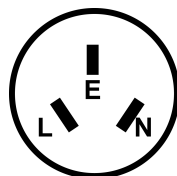

China
IT-E171

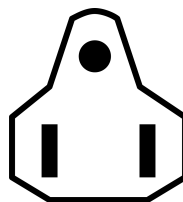

United States &
Canada & Japan
IT-E172

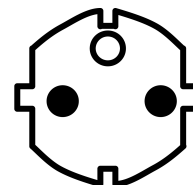

Europe
IT-E173

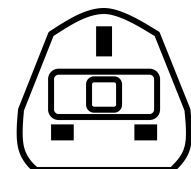

England
IT-E174

Connecting Method:

1. Please ensure the power switch of the instrument is turned Off.
2. Connect one end of the power cord to the AC input connector on the rear panel of the instrument.
3. Connect the other end of the power cord to the socket configured with protective earth.

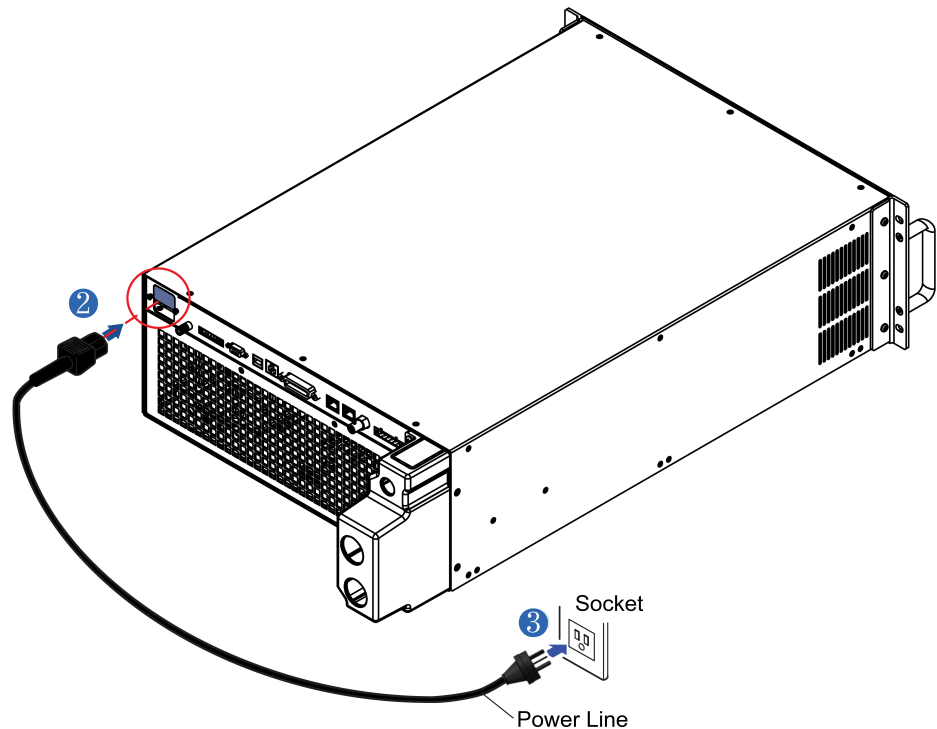

- Other models (15U, 27U and 37U instruments) provides the standard power cords as below.

Connecting Method:

1. Please ensure the power switch of the instrument is turned Off.
2. Remove the protective cover outside the AC input terminal on the rear panel.
3. See the below illustration, connect one end of the AC power cord to the AC input terminal in the rear board of the instrument. Connect the fire wire, zero line and ground to the corresponding terminal of the device. Connect the brown terminal to line (L), blue to neutral (N), and yellow-green to ground.
4. Mount the protective cover back to its original position.
5. Connect the plug on the other end of the power cord to a grounded AC outlet.

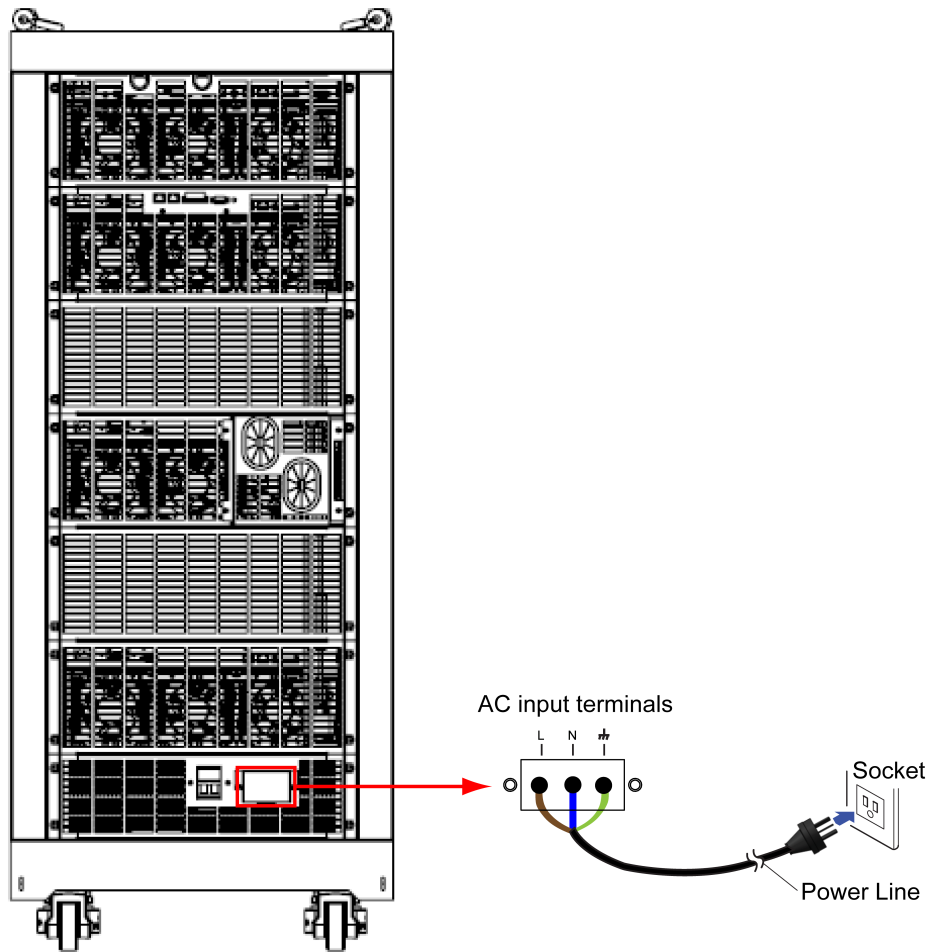

1.5 Connecting the DUT

Before connecting the DUT

To avoid burning out and electric shock, The safety precautions must be observed.

WARNING

- Before connecting the DUT, be sure to switch off the power supply of the test loop in order to avoid electric shock.
- To avoid electric shock, before testing, please make sure the rating values of the testing lines, and do not measure the current that is higher than the rating value.
- Always use test lines provided by ITECH to connect the equipment. If test lines from other factories are used, please check that the test line can withstand maximum current.
- When using switch-type devices to directly connect the test object and electronic load, there will be a voltage surge at the moment the switch device is closed. The excessively high voltage surge will damage the electronic load. To avoid loading the load with a high voltage surge, it is recommended to connect a current-limiting resistor in series in the circuit. When the test current is less than 1000A, the IT-E165A module can be directly connected in series. The IT-E165A module is an optional accessory and needs to be purchased separately. The connection method for IT-E165A is detailed in reference [Connect the IT-E165A](#), and the method for connecting a series current-limiting resistor is detailed in reference [Precautions for connecting batteries](#).

Specification

- Test lines are not standard accessories of the 4U instruments. Please select optional red and black test lines for individual sales based on the maximum current value. For specifications of test lines and maximum current values, refer to [A.1 Specifications of Red and Black Test Lines](#).

If you want to make test lines by yourself, please refer to the maximum current value and the poles' size, as shown in the following figure.

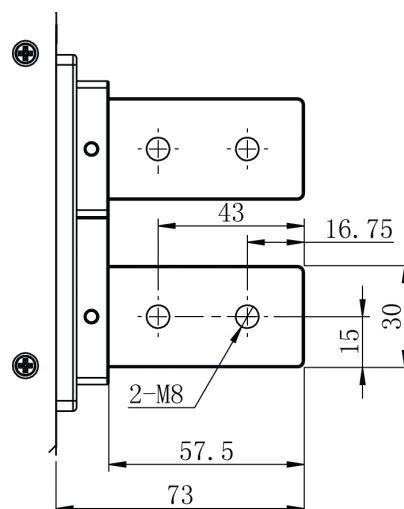

- Other models (8U, 15U, 27U and 37U instruments) are standard equipped with a set of red and black test lines, the test lines specification are 95mm² / 3m. However, for instruments with a rated current greater than 500A, the

user need to purchase additional 1 to 5 test lines. Please select optional red and black test lines for individual sales based on the maximum current value. For specifications of test lines and maximum current values, refer to [A.1 Specifications of Red and Black Test Lines](#).

If you want to make test lines by yourself, please refer to the maximum current value and specifications of standard test lines .

Connecting the DUT (local measurement)

The steps of local measurement are as follows:

1. Before connecting the test lines, be sure that the instrument Power is in Off position.
2. Remove the load input terminal cover.
3. Loosen the screws of the input terminals and connect the red and black test lines to the input terminals. Re-tighten the screws.

When maximum current that one test line can withstand fails to meet the current rated current, use several pieces of red and black test lines. For example, the maximum current is 1,200A, then 4 pieces of 360A red and black lines are required.

4. Install the load input terminal cover.
5. Directly connect the other end of the red and black lines to the DUT terminals.

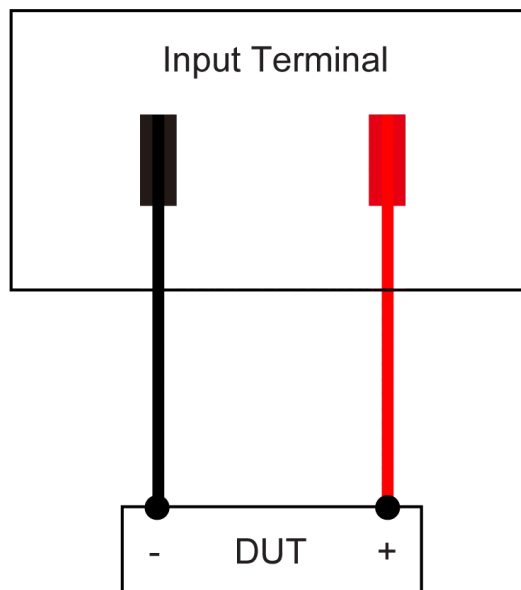

Connecting the DUT (remote measurement)

Under CC, CV, CR or CW mode, if the load consumes large current, a large voltage drop will be detected in connection line between tested instrument and load terminal. To ensure measurement accuracy, a remote sense measurement terminal is provided at load rear board to compensate voltage drop lost in wire.

Remote sense operation: VS+ and VS- are remote input terminals. To avoid voltage drop caused by long input wire of load, the remote sense test allows direct measurement at input terminal source so as to improve measurement accuracy.

The steps of remote measurement are as follows:

1. Press **[Shift]+[9]**(Config) keys to enter the interface of configuration menu.
2. Operate Left/Right key and select Remote-Sense. Press **[Enter]** key.
3. Select ON to start Sense function; the instrument is set to remote sense measurement mode.
4. Connect the instrument and DUT as shown in the following figure.

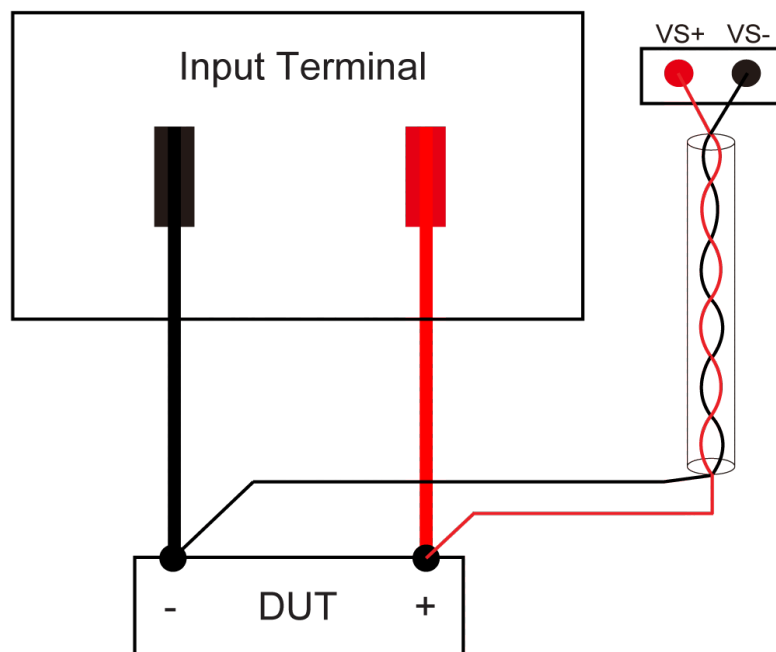

Note

Test lines and sense lines should be as short as possible, and sense lines should be twisted together.

Connect the IT-E165A

When using switch-type devices to directly connect the test object and electronic load, there will be a voltage surge at the moment the switch device is closed. The excessively high voltage surge will damage the electronic load. To avoid loading the load with a high voltage surge, it is recommended to connect a current-limiting resistor in series in the circuit. When the test current is less than 1000A, the IT-E165A module can be directly connected in series. The IT-E165A module is an optional accessory and needs to be purchased separately. The connection method for IT-E165A is detailed as follows, and the method for

connecting a series current-limiting resistor is detailed in reference [Precautions for connecting batteries](#).

1. Make sure that the power of the DUT, IT-E165A, and IT8400 is turned off.
2. Refer to the following diagram to connect the IT8400 series instrument and the DUT.

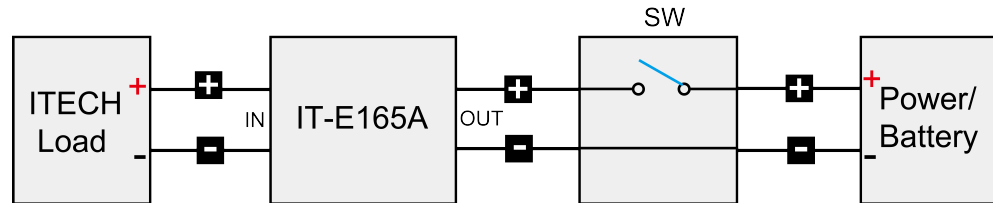

3. Connect the power cord of IT-E165A.
4. Start the DUT and turn on the IT8400 power switch.
5. Turn on the Power switch of the IT-E165A.

2 Quick Reference

This Chapter will introduce power-on check steps of this series to ensure normal start-up and usage under initialization status of the load. Besides, to facilitate usage, this part also displays the functions of front board, rear board and keyboard keys as well as display functions to a quick view of load appearance, structure and key usage functions before operation.

- ◆ [Brief Introduction](#)
- ◆ [Front Panel Introduction](#)
- ◆ [Keyboard Introduction](#)
- ◆ [Fast Function Key](#)
- ◆ [Function Description of VFD Status Indicators](#)
- ◆ [Rear Panel Introduction](#)
- ◆ [Power-on Selftest](#)

2.1 Brief Introduction

IT8400 high-performance DC electronic load has two voltage levels, 600V and 1200V. It supports master-slave connection in parallel with power from 6 kW to 600 kW, and is capable of fast double power loading. It has three current readback ranges with a resolution of up to 40uA. IT8400 has faster loop response and current rising and falling speed. It supports up to 8 working modes. It also has dynamic mode, List, OCP, OPP test, automatic test and battery test functions. IT8400 has built-in CAN, LAN, GPIB, USB, RS232 and analog interfaces, suitable for remote control and system building. In addition, the full protection function makes it well matched with the test of fuel cell, power battery discharge, DC charging pile, BOC, power electronics, solar, automotive high-voltage components, DC-DC, motor and so on.

Feature:

- Max.Voltage : 1200V
- Current range: 1.5A~15,000 A
- Power extended to 600 kW through master-slave connection in parallel
- High-precision three current measurement ranges with resolution up to 40uA
- Fast double power loading capability (<3 s)
- 25kHz fast dynamic mode, current rising and falling time is adjustable
- Provide 8 working modes: CC, CV, CR, CW, CC+CV, CV+CR,CR+CC, CW+CC

- 1 kHz continuous sampling rate
- List programming
- The battery discharge function is used to test energy storage devices such as batteries and super capacitors
- CV loop speed is adjustable to match different power supplies
- 500 kHz voltage and current sampling rate
- Time measurement, OCP/OPP test short circuit simulation, automatic test
- I-monitor function
- Full protection: OVP, OCP, OPP, OTP, current oscillation protection, current limit, power limit, reverse alarm, etc.
- Power-off retention memory function, recording up to 100 groups data
- Independent control, easy to maintain and install.
- Built-in standard LAN, USB, RS232, GPIB, CAN and analog interface
- LabVIEW driver and SCPI protocol

Input parameter	600V	1200V	height
6 kW	IT8406-600-150	IT8406-1200-75	4 U
12 kW	IT8412-600-300	IT8412-1200-150	8 U
18 kW	IT8418-600-450	IT8418-1200-225	15 U
24 kW	IT8424-600-600	IT8424-1200-300	27 U
30 kW	IT8430-600-750	IT8430-1200-375	27U
36 kW	IT8436-600-900	IT8436-1200-450	27U
42 kW	IT8442-600-1050	IT8442-1200-525	37U
48 kW	IT8448-600-1200	IT8448-1200-600	37U
54 kW	IT8454-600-1350	IT8454-1200-675	37U

Note

- The curves indicating relationship between the rated input power, input voltage and internal temperature of IT8400 series load is shown in the following figure.

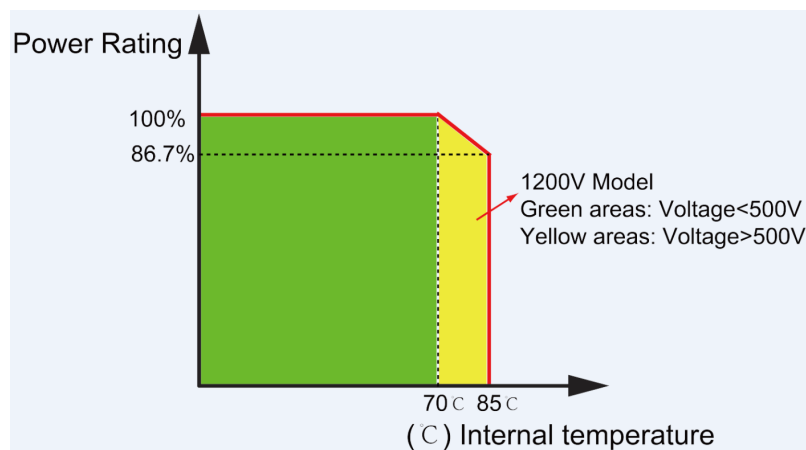
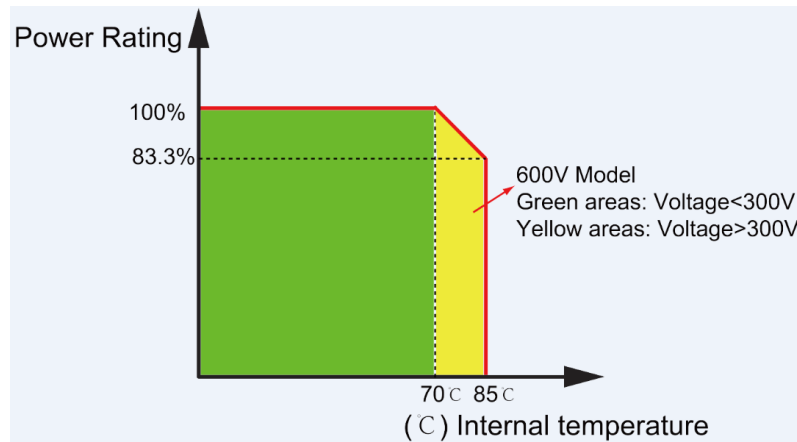

- The naming rule of the IT8400 series is IT84XX-YY-ZZ, where XX represents the rated power of the model, YY represents the rated voltage and ZZ represents the rated current.

2.2 Front Panel Introduction

All of this series electronic loads have the same front panel. The front panel diagram and key diagram of 4U model is shown in the figure below; descriptions of the numbered items follow the figure.

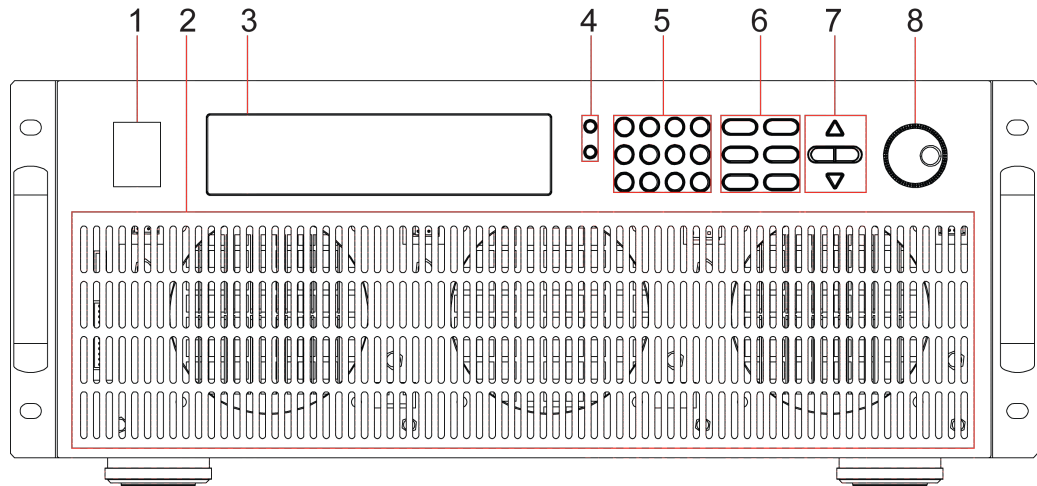

1. Power switch
2. Ventle hole
3. VFD screen
4. Shift and Local keys
5. Number key and composite key
6. Function keys
7. Up, Down, Left and Right key, to move cursor
8. Adjusting knob



2.3 Keyboard Introduction

The keyboard is shown in the following figure; Descriptions of the key function follow the figure below.



Detailed description of keys.

Key Name	Description
[Shift]	[Shift] Composite key.
[Local]	[Local] key, To shift local and remote operation.

Key Name	Description
[0]~[9]	[0]~[9] are numeric keys.
.	Dot
[Esc]	[Esc] key, To exit at any working status.
[CC]	To select constant current mode and set current input value.
[CV]	To select constant voltage mode and set voltage input value.
[CR]	To select constant resistance mode and set resistance input value.
[CW]	To select constant power mode and set constant power input value.
[Enter]	[Enter] key.
[On/Off]	To control input status of load: on/off.
	Up/Down key, to select menu items during menu operation.
	Left/Right key, to adjust the cursor to the specified location to set the value.

2.4 Fast Function Key

A combination of front panel keys and **[Shift]** composition keys in this series load can realize functions marked at key bottom. For details, see table below.

Keys	Name and functions
[Shift]+[1] (Short)	To start or end short circuit test.
[Shift]+[2] (Tran)	To set dynamic operation parameters.
[Shift]+[3] (List)	To set list operation function.
[Shift]+[4] (Save)	To save existing setting load parameter values, e.g., voltage, current and power.
[Shift]+[5] (Battery)	To operate battery test function.

Keys	Name and functions
[Shift]+[6] (Prog)	To operate auto test function.
[Shift]+[7] (Info)	To display model, version number and serial number of electronic load.
[Shift]+[8] (System)	To set system menu.
[Shift]+[9] (Config)	To set configuration menu.
[Shift]+[0] (Pause)	To pause operation during automatic test.
[Shift]+[.] (Trigger)	Trigger key, to start up triggering functions.
[Shift]+[CC] (OCP)	To operate OCP test function.
[Shift]+[CV] (Setup)	To set specific parameters of constant voltage, constant current, constant resistance and constant power.
[Shift]+[CW] (OPP)	To operate OPP test function.
[Shift]+[Enter] (Recall)	To select stored load parameter values, e.g., voltage, current and power setting values.
[Shift]+[On/Off] (Lock)	To operate Keyboard locking function.

2.5 Function Description of VFD Status Indicators

The VFD indicator lamps introduction of this series load is shown as follows.

Flag	Function introduction	Flag	Function introduction
OFF	The load is off.	Error	The load has error.
CC	The load is under constant current mode.	Trig	The load is waiting for triggering signal.
CV	The load is under constant voltage mode.	Sen-se	The load is under remote sense input mode.
CR	The load is under constant resistance mode.	Prot	The load is under software over-current protection status.
CW	The load is under constant power mode.	Rear	Start external analog quantity function.

Flag	Function introduction	Flag	Function introduction
Rmt	The load is under remote operation mode.	Auto	Start automatic voltage range.
Addr	Send command under remote operation.	*	Start keyboard locking function
SR-Q	Serial request query.	Shift	Shift key is pressed.

2.6 Rear Panel Introduction

- Schematic Diagram of Rear Panel of this series (4U) electronic load.

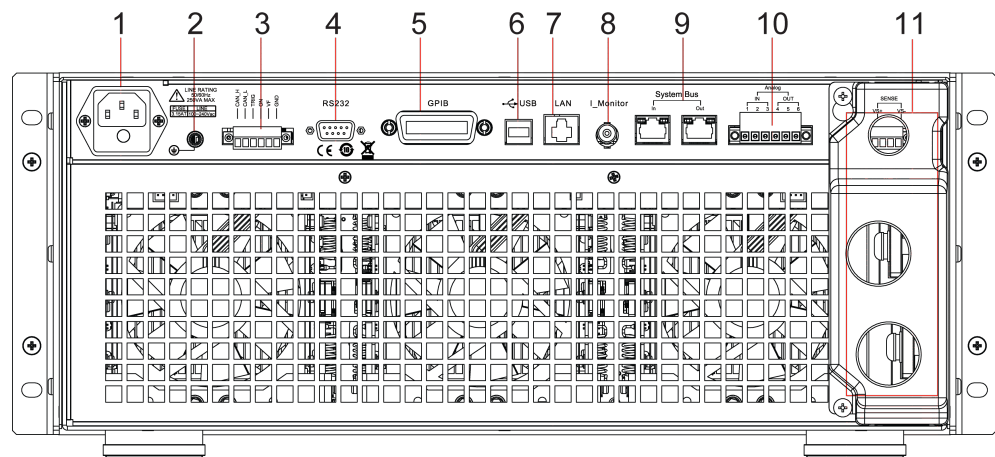

1. AC power input socket (including fuse)
 2. Ground terminal
 3. External signal control interface
 4. RS232 communication interface
 5. USB communication interface
 6. LAN communication interface
 7. GPIB communication interface
 8. SYSTEM BUS interface
 9. Current monitoring terminal
 10. External analog 0-10 V control terminal
 11. Remote sense compensation terminal and input terminal
- Schematic Diagram of Rear Panel of this series (8U) electronic load.
This series (8U) load consists of two electronic loads (4U). The electronic load (4U) with front panel is the master and the other is the slave.

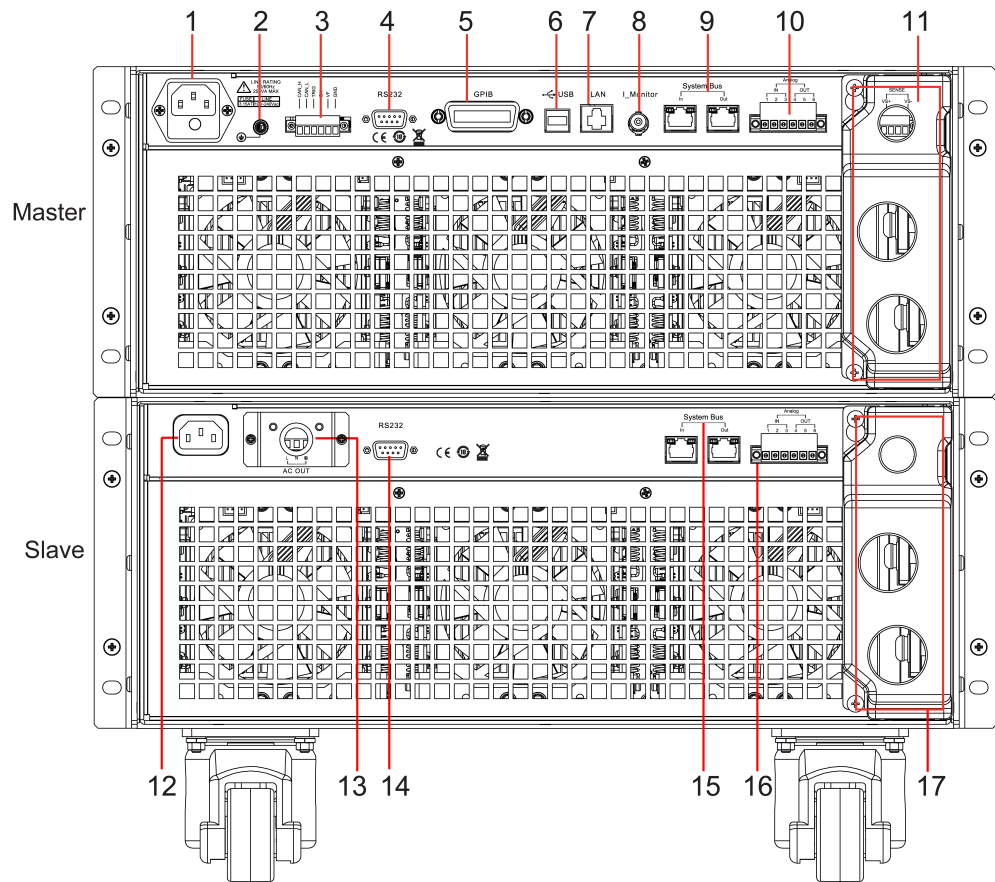

1. AC input socket of master, has been connected to AC OUT terminals of slave.
2. Ground terminal
3. External signal control interface
4. RS232 communication interface
5. USB communication interface
6. LAN communication interface
7. GPIB communication interface
8. SYSTEM BUS interface
9. Current monitoring terminal
10. External analog 0-10 V control terminal
11. Remote sense compensation terminal and input terminal
12. AC input socket of slave
13. AC OUT terminals of slave
14. RS-232 communication interface, used for slave calibration
15. SYSTEM BUS interface of slave, has been connected to SYSTEM BUS interface of master
16. Analog terminal of slave, has been connected to Analog terminal of master
17. Input terminal of slave, has been connected to Input terminal of master

- Schematic Diagram of Rear Panel of this series (15U) electronic load is shown as below, model 27U and model 37U have the same rear panels as 15U model. Only the sizes are different.

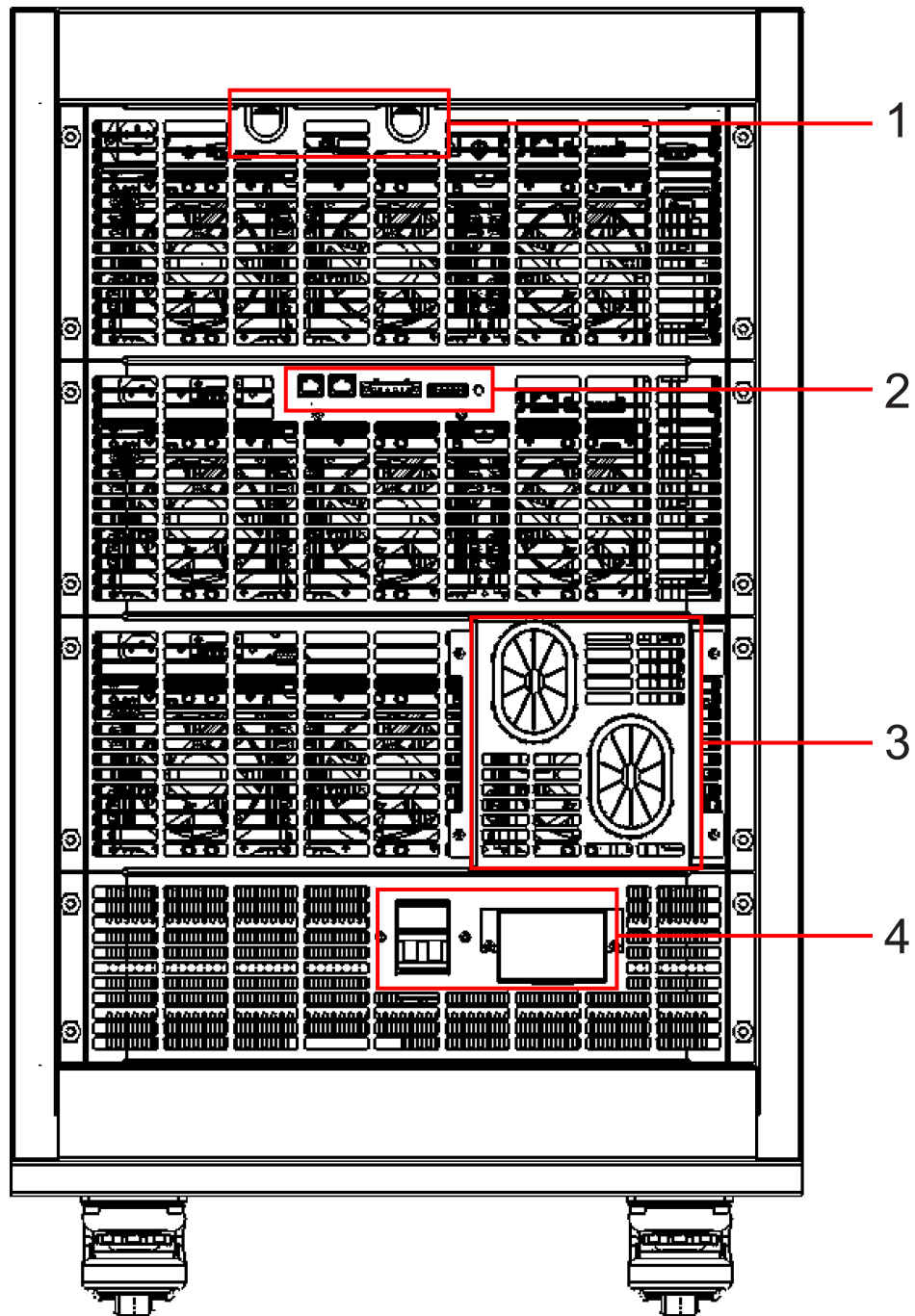

1. Threading hole for communication interface

To use the communication interface function , please remove this panel before connecting the terminals.

2. SYSTEM BUS interface, external analog control terminal, remote sense terminal and latch button SW.

You can switch the control state of the instrument between local control and remote control by using the latch button SW. Press the latch button SW to RP state, indicates the instrument is in the remote control. Press the latch button SW again to LP state, indicates the instrument is in local control.

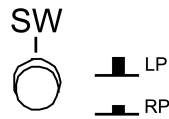

The latch button SW of the instrument which is in single mode must keep LP state.

3. Input terminal
4. AC power switch and AC power input terminal

2.7 Power-on Selftest

A successful selftest indicates that the purchased load product meets delivery standards and is available for normal usage. Before operation, please confirm that you have fully understood the safety instructions.

WARNING

- **To avoid burning out, be sure to confirm that power voltage matches with supply voltage.**
- **Be sure to connect the main power socket to the power outlet of protective grounding. Do not use terminal board without protective grounding. Before operation, be sure that the electronic load is well grounded.**
- **To avoid burning out, pay attention to marks of positive and negative polarities before wiring.**

Selftest Steps

Normal selftest procedures:

1. Correctly connect the power line. Press **[Power]** key to start up.
The VFD screen displays the software version number
BIOS Ver 1.10
2. After approximately 1s, the system starts conducting self-test and the VFD displays
System Selftest...
3. After the self-test, the VFD displays information, as shown in the below.
0.00V 0.00A
0.0W CC=0.00A

Information description:

- The first line displays actual input voltage and current values.
 - The second line displays actual power value and setting values of current (voltage, power and resistance).
4. Press **[Shift]+[7]**(Info), the VFD screen displays related information of the product, as shown below.
 IT84XXX-XXXX-XXX
 Ver:0.XX-0.XX-1.XX
 SN:XXXXXXXXXXXXXXXXXXXX
 5. Press Up/Down key to switch between the display of product model, software version number, and product serial number.

Error Information References

The following error information may occur when an error occurs during Power On self-test:

Error information	Error information explanation
Eeprom Failure	EEPROM Failure
CAL data lost	Calibration data is lost
Factory data lost	Factory data is lost
System data lost	System setting data is lost

Exception handling

If the electronic load cannot start normally, please check and take measures by reference to steps below.

1. Check whether the power line is correctly connected and confirm whether the electronic load is powered.
 Correct wiring of power line => 2
 Incorrect wiring of power line => Re-connect the power line and check whether the exception is removed.
2. Check whether the power in On. **[Power]** key is under “I” On status.
 Yes => 3
 No => Please check the **[Power]** key to start power and check whether the exception is removed.
3. Check whether set power voltage of electronic load is larger than the power supply voltage.
4. Check whether the fuse of the instrument is burned out.

If fuse is burnt out, replace the fuse with the same type and rating. The specification is 3.15AT/250V. Refer to [A.2 Fuse Replacement](#) for detailed replacement procedures.

3 Function and Features

This chapter describes in detail the use of the front-panel keys and shows how they are used to accomplish instrument operation. This chapter is divided into the following sections:

- ◆ Switching of Local/Remote Operation Modes
- ◆ Constant-status Operation Mode
- ◆ Input Control Function
- ◆ Keyboard Locking Function
- ◆ Short-circuit Analog Function
- ◆ System Menu Function(System)
- ◆ Configuration menu function (Config)
- ◆ Triggering Function
- ◆ Dynamic Test Function
- ◆ OCP Test Function
- ◆ OPP Test Function
- ◆ Battery discharge test function
- ◆ CR-LED test function
- ◆ Measure Function
- ◆ Configuration Save Function
- ◆ VON Function
- ◆ Protective Function
- ◆ List Operation
- ◆ Terminal Function of Rear Panel
- ◆ Auto Test Function
- ◆ Parallel Function

3.1 Switching of Local/Remote Operation Modes

The electronic load is provided with local and remote operation modes. These two modes can be switched through communication commands. At initialization, the electronic load is defaulted under local operation mode.

- Local operation mode: for operating related functions through keys on the electronic load machine.
- Remote operation mode: for operating related functions of the electronic load on PC through a connection between the electronic load and PC. Under remote operation mode, except **[Local]**key, other keys on the board are disabled. The **[Local]** key can be used for switching to local operation mode.

3.2 Constant-status Operation Mode

The electronic mode can work under the 4 constant-state operation modes:

- Constant current operation mode (CC)
- Constant voltage operation mode (CV)
- Constant resistance operation mode (CR)
- Constant power operation mode (CW)

3.2.1 Constant Current Operation Mode (CC)

Under CC mode, the electronic load will consume constant current in regardless of whether the input voltage changes or not, as shown in the following figure.



Under CC mode, the electronic load provides three ways to set constant current.

- Rotate adjusting knob to set constant current value.
- Use numeric keys to input current value and press **[Enter]** key to confirm set constant current value.
- Use Left/Right key moving cursor and press Up/Down key to adjust values at corresponding positions.

Operation steps

1. Press **[CC]** key and **[Shift]+[CV]**(Setup) to enter parameter setting screen.

```
Constant Current
Range=240.00A
```

2. Set maximum working current value and press **[Enter]** for confirmation.

```
Constant Current
Range =200.00A
```

3. Set maximum voltage value and press **[Enter]** key.

```
Constant Current
High=1205.0V
```

4. Set minimum voltage value and press **[Enter]** key.

```
Constant Current
```

Low=0.0V

- Set high and low rate and press **[Enter]** key.

Constant Current
High-Rate Low-Rate

- Set ascending slope and press **[Enter]** key.

Constant Current
Rise up=2.0000A/mS

- Set descending slope and press **[Enter]** key.

Constant Current
Fall down=2.0000A/mS

- Complete parameter setting.

0.0V 0.00A
0.0W CC=0.00A



Note

If the above method is for editing auto test step (as mentioned below), constant current range can also be set.

3.2.2 Constant Voltage Operation Mode (CV)

Under CV mode, the electronic load will consume sufficient current to maintain the input voltage at setting voltage, as shown in the following figure.

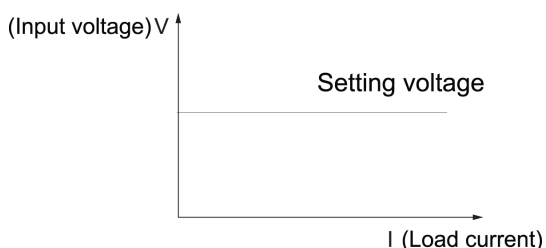

Under CV mode, the electronic load provides three ways to modify constant voltage.

- Rotate adjusting knob to set constant voltage value.
- Use numeric keys to input voltage value and press **[Enter]** key to confirm set constant voltage value.
- Use Left/Right key moving cursor and press Up/Down key to adjust values at corresponding positions.

Operation Steps

- Press **[CV]** key and **[Shift]+[CV]**(Setup) to enter parameter setting screen.

Constant Voltage

Range=1200.0V

2. Set maximum working voltage value and press **[Enter]** for confirmation.

Constant Voltage

Range=1000.0V

3. Set maximum current value and press **[Enter]** key.

Constant Voltage

High=252.00A

4. Set minimum current value and press **[Enter]** key.

Constant Voltage

Low=0.00A

5. Set limited current value under CV mode and press **[Enter]** key.

Constant Voltage

I-Limit=240.00A

6. Set high and low rate and press **[Enter]** key.

Constant Voltage

High-Rate Low-Rate

7. Complete parameter setting.

0.0V 0.00A

0.0W CV=1000.0V



Note

If the above method is for editing auto test step (as mentioned below), constant voltage range can also be set.

3.2.3 Constant Resistance Operation Mode (CR)

Under CR mode, the electronic load is equivalent to a constant resistance (as shown below) and will give linear change of current with input voltage change, as shown in the following figure.

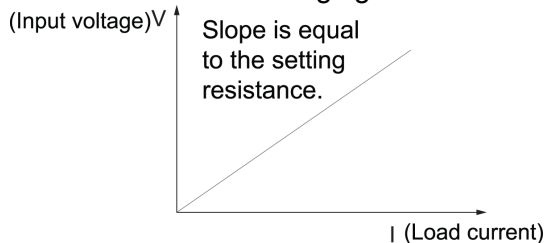

Under CR mode, the electronic load provides three ways to modify constant resistance.

- Rotate adjusting knob to set constant resistance value.
- Use numeric keys to input resistance value and press **[Enter]** key to confirm set constant resistance value.

- Use Left/Right key moving cursor and press Up/Down key to adjust values at corresponding positions.

Operation Steps

1. Press **[CR]** key and **[Shift]+[CV]**(Setup) to enter parameter setting screen.

```
Constant   Resistance
Range=7500.0Ω
```

2. Set maximum working resistance value and press **[Enter]** for confirmation.

```
Constant   Resistance
Range =7000.0Ω
```

3. Set maximum voltage value and press **[Enter]** key.

```
Constant   Resistance
High=1205.0V
```

4. Set minimum voltage value and press **[Enter]** key.

```
Constant   Resistance
Low=0.0V
```

5. Set limited current value under CR mode and press **[Enter]** key.

```
Constant   Resistance
I-Limit=240.00A
```

6. Complete parameter setting.

```
0.0V      0.00A
0.0W      CR=7000.0Ω
```



Note

If the above method is for editing auto test step (as mentioned below), constant resistance range can also be set.

3.2.4 Constant Power Operation Mode (CW)

Under CW mode, the electronic load will consume a constant power, as shown below. If input voltage rises, the input current decreases and power $P (= V * I)$ will maintain at setting power, as shown in the following figure.

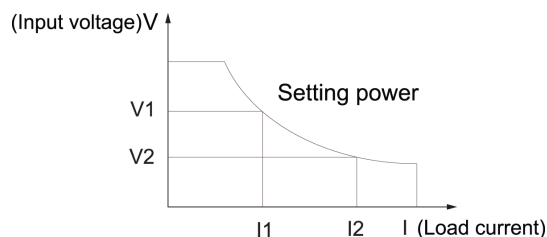

Under CW mode, the electronic load provides three ways to modify constant power.

- Rotate adjusting knob to set constant power value.
- Use numeric keys to input power value and press **[Enter]** key to confirm set constant power value.
- Use Left/Right key moving cursor and press Up/Down key to adjust values at corresponding positions.

Operation Steps

1. Press **[CW]** key and **[Shift]+[CV]**(Setup) to enter parameter setting screen.

```
Constant   Power
Range=6000.0W
```

2. Set maximum working power value and press **[Enter]** for confirmation.

```
Constant   Power
Range =5000.0W
```

3. Set maximum voltage value and press **[Enter]** key.

```
Constant   Power
High=1205.0V
```

4. Set minimum voltage value and press **[Enter]** key.

```
Constant   Power
Low=0.0V
```

5. Set limited current value under CW mode and press **[Enter]** key.

```
Constant   Power
I-Limit=240.00A
```

6. Complete parameter setting.

```
0.0V      0.00A
0.0W      CW=0.0W
```



Note

If the above method is for editing auto test step (as mentioned below), constant power range can also be set.

3.2.5 Compound Operation Mode

This series electronic load has four compound operation modes: CV+CC, CV+CR(CR-LED), CR+CC and CW+CC. These four compound operation modes add I-Limit (limited current value) setting function under CV/CR/CW mode, which can help engineers solve the transient surge current problems, avoid to trigger the protection function and protect DUT from burning.

For example, in charging station test, the electronic load needs to rise up to 700V under CV mode. During test process, in order to stabilize electronic load

at 700V faster, the current value will suddenly increase too much due to the fast rising speed, which will cause the charging station into OCP status and stop outputting. To avoid the similar problems, we can use CV+CC mode to set a limited current value so that the internal current adjustment will be no more than the over-current protection level, which will avoid the surge current and solve the OCP problem in charging station. The common applications for the four compound operation modes are as follows.

- The CV+CC mode can be applied to the load simulation battery and test the charging station or the car charger. When the CV is working, the maximum loading current is limited.
- The CR+CC mode is commonly used in the testing of voltage limiting, current limiting characteristics, constant voltage accuracy, and constant current accuracy of on-board chargers, which prevents over-current protection of on-board chargers.
- The CW+CC mode is often used to UPS battery test, simulate the current change when the battery voltage is decaying. It can also be used to simulate the characteristics of the inputs of DC-DC converters and inverters.

The operation procedures for CV+CC compound mode is shown as follows. CR+CC and CW+CC compound modes are the same.

1. Press **[CV]** key to switch into CV mode. Press numeric keys to set the constant voltage value.

```
0.0V      0.00A
0.0W      CV=1000.0V
```

2. Press the **[Shift]+[CV]** (Setup) keys to enter the parameter setting page.

```
Constant Voltage
Range=1200.0V
```

3. Set the maximum working voltage value, and enter the **[Enter]** key.

```
Constant Voltage
Range=1000.0V
```

4. Press up and down keys to select "I-Limit=240.00A". Set the limited current value under CV mode and press **[Enter]** to confirm.

```
Constant Voltage
I-Limit=240.00A
```

5. Press **[Esc]** to exit setting.

3.3 Input Control Function

Control input switch of the electronic load by pressing **[On/Off]** key on the front board. If **[On/Off]** lamp is on, the input is on; and if **[On/Off]** lamp is off, the input is off. When the electronic load input is on, the VFD status indicator "OFF" is unlit.

3.4 Keyboard Locking Function

Press the composite key **[Shift]+[On/Off]**(Lock) to lock the instrument board key, and the VFD displays *. Under this function statuses, except **[On/Off]** key and **[Shift]+[On/Off]**(Lock), other keys are disabled. Press this composite key to cancel locking.

3.5 Short-circuit Analog Function

The electronic load can analog a short circuit. On the front panel, press **[Shift]+[1]** to switch to the short circuit mode. The short circuit mode does not influence the existing settings. When the short-circuit analog is turned off, the instrument returns to the previous setting status.

In the short circuit mode, the current value is determined by the operation mode and the current range. Under CC, CW and CR modes, maximum short-circuit current is 110% of the current range. Under CV mode, short-circuit current equals to current when constant voltage is 0 V.

3.6 System Menu Function(System)

Press **[Shift]+[8]**(System) to enter system menu setting.

Initialize	INITIALIZE SYSTEM?		
		NO	Keep existing configurations.
		YES	Recover all configurations to factory set values.
Power-On	POWER ON		
		Rst(Def)	Set the input status of load at powering on as "status as delivered".
		Sav0	Set the input status of load at powering on as SAVE 0 value.
Buzzer	BUZZER STATE		Set the buzzer status.
		Off	Set the buzzer as OFF status.
		On(default)	Set the buzzer as ON status.
Knob	LOAD ON KNOB MODE		Set the pulse knob.
		Update(default)	Real-time update.
		Old	No update (Recover to original value at ON/OFF).

Trigger	TRIGGER SOURCE		Set triggering mode.
		Manual(Def)	Manual trigger.
		External	External signal trigger mode.
		Hold	Trig:IMM valid.
		Bus	GPIB bus trigger mode.
		Timer	Timer trigger mode.
			Timer=1.00S
Memory	MEMORY		Work with Recall button to recall 100 sets saved parameters.
		Group= (0-9)	0: represents 1-10 sets; 1: represents: 11-20 sets, by parity of reasoning.
Displ	DISPLAY ON TIMER		Screen displays loading time.
		Off(default)	Stop function.
		On	Start function.
Communciation	COMMUNICATION		Select the interface for communication with a computer.
		RS232	Select the RS232 communication interface.
			Set baud rate: 4800/9600/19200/38400 /57600/115200
			Set data bit: 8
			Set parity check bit: N
			Set stop bit: 1
			Set handshake protocol: NONE
		USBTMC	Select the USB communication interface.
		GPIB	Select the GPIB communication interface, Address(0-31)
		LAN	Select the LAN communication interface.
			Gateway= 192.168.0.1
			IP= 192.168.0.125
			Mask= 255.255.255.0
			Socket Port= 30000
Parallel	PARALLEL		Parallel mode set up.
		Single	Single mode.
		Slave	Act as a slave mode.
		Master	Act as a master mode.

		Total = 3	Set total number of instruments in parallel.
--	--	-----------	--

3.6.1 Restored to Factory Setting(Initialize)

This option is used to restore all settings in the system menu to factory setting values.

1. Press the composite key **[Shift]+[8]**(System) to enter system menu setting screen.
2. Operate Left/Right key and move to the Initialize and press **[Enter]** key.
3. Select "YES" and Press **[Enter]** to restore to factory setting values. In this case, all set values in the system will be restored to factory setting values, i. e., the (Def) mark values.

3.6.2 Power On Parameter(Power-On)

This parameter determines the state of electronic load after power up. If you select "Rst", the default input parameter settings will be active after power up. If you select "Sav 0", then the electronic load will automatically recall the input parameters setting saved in 0 register.

3.6.3 Key Sound Set(Buzzer)

This item can set the buzzer state. On option indicates that when you push buttons, the buzzer will sound. Off option indicates that the buzzer function is disabled. Factory default is On option.

1. Press the composite key **[Shift]+[8]**(System) to enter system menu setting screen.
2. Operate Left/Right key and move to the Buzzer and press **[Enter]** key.
3. Select On or Off to change the buzzer status.

3.6.4 Rotary Knob Set(Knob)

This item is used to set rotary knob state. In Update mode, you can use this rotary knob to set the input value . Rotate the knob clockwise to increase the set value and anticlockwise to decrease the set value. In Old mode, this knob can't be used. Factory default is Update option.

1. Press the composite key **[Shift]+[8]**(System) to enter system menu setting screen.
2. Operate Left/Right key and move to the Knob and press **[Enter]** key.

3. Select Update or Old to change the knob setting.

3.6.5 Trigge Mode(Trigger)

Triggering function is necessary to operate dynamic pulse output and list output. There are five kinds of trigger options: Manual, External, Hold, Bus and Timer

1. Press the composite key **[Shift]+[8]**(System) to enter system menu setting screen.
2. Operate Left/Right key and move to the Trigger and press **[Enter]** key.
3. Press Left/Right key to select trigger method and press **[Enter]** to complete setting.
 - Manual (Def): manual trigger
 - External: external signal trigger
 - Hold: special command trigger
 - Bus: BUS command trigger
 - Timer: timer trigger

3.6.6 Set Memory Group(Memory>Group)

The electronic load can save some commonly-used parameters in 100-group NVM for convenient and fast usage. The **[Shift]+[4]**(Save) keys can be used for saving parameters. The **[Shift]+[Enter]**(Recall) key is for quick invoking.

When you want to recall the data saved in the memory, you should set memory group in the system menu first. Group 0 means you can recall data saved in 0 to 10 groups. Group 1 means you can recall data saved in 11 to 20 groups. Group2 to Group 9 can be concluded in the same manner. The operation procedures for setting Group number is shown as follows.

1. Press the composite key **[Shift]+[8]**(System) to enter system menu setting screen.
2. Operate Left/Right key and move to the Memory and press **[Enter]** key.
3. Press numeric keys to set Group number.

3.6.7 Loading Time Display Set(Displ)

This menu item can set if the main screen displays the loading time or not. If On is selected, the main screen displays the loading time. If Off is selected, the loading time will not be displayed. Factory default is Off option.

1. Press the composite key **[Shift]+[8]**(System) to enter system menu setting screen.

2. Operate Left/Right key and move to the Dspl and press **[Enter]** key.
3. Operate Left/Right key and move to the On and press **[Enter]** key. The screen will display the loading time.

3.6.8 Communication Set

Under this item, you can set the specific communication mode. This unit has provided multiple communication interfaces: RS232/USB/GPIB/LAN. You can choose any one of them to communicate.

1. Press **[Shift]+[8]**(System) to enter system menu setting.
2. Press Left/Right key to select "Communication". Press **[Enter]** key.
3. Press left or right keys to select communication interface: RS-232/USBTMC/GPIB/LAN.

Please ensure the configuration consistency between our instrument and PC, so that you could have a successful communication.

- To select RS232 communication mode, you need to configure the baud rate 4800/9600/19200/38400/57600/115200, data bit 8 bits, parity bit N and stop bit 1 bit.
- To select the GPIB communication method, you need to configure the address. The address setting range is 0-31.
- To select the LAN communication method, you need to configure the gateway address, IP address, mask address and socket port.

3.7 Configuration menu function (Config)

Press **[Shift]+[9]**(Config) to enter menu configuration.

Von	VOLTAGE ON	Set the load's von point	
	Living	Von point living state, ON /OFF	
		Point= 0.00V	Set the Von value.
	Latch	Von point latch state, ON /OFF	
		Point= 0.00V	Set the Von value.
Protect	PROTECT MENU		
	Max-P	Set hardware power protection.	
		MAX POWER	
		Point=2000.0W	Set hardware protective power value.
	I-Limit	Set software current protection.	
		CURRENT LIMIT	

		Off	Stop function.
		On	Start function.
		Point=240.00A	Set software current protective value.
		Delay= 3S	Set software current protective delay.
	P-Limit	Set software power protection.	
		POWER LIMIT	
		Point=2000.0W	Set software power protective value.
		Delay= 3S	Set software power protective delay.
	Timer	Set LOAD ON timer.	
		ON-TIMER	
		Off	Stop function.
		On	Start function.
		ON-TIMER	
		Delay=10.00S	Set LOAD ON timer value.
	OSC	Set current oscillation protection	
		Off	Stop function.
		On	Start function.
Measure	MEASURE MENU		
	V-Range	Auto switch function of voltage range.	
		VOLTAGE AUTO RANGE	
		On	Start auto voltage range.
		Off	Stop auto voltage range.
	Time V	Measure voltage rise/fall time.	
		TIMER VOLTAGE FUNC	
		Low	Set low voltage value.
		Point1=0.00V	
		High	Set high voltage value.
		Point2=1200.0V	
	Time C	Measure current rise/fall time.	
		TIMER CURRENT FUNC	
		Low	Set low current value.
		Point1=0.000A	

		High	Set high current value.
		Point2=100.00A	
	Filter	Smoothing function.	
		Average Count=2^(2~16)	Set of average count.
CR-LED	CR LED MODE	Analog LED lamp function (under CR mode).	
	On	Start CR-LED function.	
	Off	Stop CR-LED function.	
Remote-Sense	REMOTE SENSE STATE	Remote sense compensation measurement.	
	Off	Stop remote sense compensation function.	
	On	Start remote sense compensation function.	
Ext-Program	EXTNAL PROGRAM	External analog quantity function.	
	Off	Stop external 0-10 V analog quantity control function.	
	On	Start external 0-10 V analog quantity control function.	
Enhance Power	Enhance Power	Transient over power loading capability	
	Off	Stop function.	
	On	Start function.	

3.7.1 On-Timer Set(Protect>Time)

This menu item can set the load-on timer for the electronic load. When On is selected, turn the input on, and then the electronic load will automatically turn the input off until the setting time runs out. When Off is selected, the load-on timer function is off.

1. Press **[Shift]+[9]**(Config) to enter configuration menu(Config Menu).
2. Press Left/Right key to select "Protect". Press **[Enter]** key.
3. Press Left/Right key to select "Timer". Press **[Enter]** key.
4. Press Left/Right key to select "On". Press **[Enter]** key.
5. Set value of load-on timer (i.e. "Delay"), and press **[Enter]** to confirm.

3.7.2 Auto-Switching Voltage Range Set(Measure>V-Range)

This menu item is used to set the voltage range to auto-switch. When On is selected, the instrument will automatically switch to high range or low range. When Off is selected, the auto-switching voltage range function is disabled.

1. Press **[Shift]+[9]**(Config) to enter configuration menu(Config Menu).
2. Press Left/Right key to select "Measure". Press **[Enter]** key.
3. Press Left/Right key to select "V-Range". Press **[Enter]** key.
4. Press Left/Right key to select "On". Press **[Enter]** key.

3.7.3 Setting Filter(Measure>Filter)

This option sets the display filter frequency of the load. The filter function of this series of load is averaging calculation.

1. Press **[Shift]+[9]**(Config) to enter configuration menu(Config Menu).
2. Press Left/Right key to select "Measure". Press **[Enter]** key.
3. Press Left/Right key to select "Filter". Press **[Enter]** key.
4. Set the filter frequency value (i.e. "Average Count"), and press **[Enter]** to confirm.

3.7.4 Set transient over power loading capability(Enhance Power)

This option is used to set transient over-power loading capability. Selecting On means turning the transient over-power loading capability function on. Selecting Off represents that the function is disabled.

Transient over power loading capability, it will make This series load to take 1.1 to 2 times the rated power loading capability in short time, users don't need to select types as maximum power value, it can extremely save cost. This function can be widely applied into the DUT transient peak power supply ability.

To ensure that the transient over-power loading capability function can work normally, please obey the following precautions.

WARNING

- **When the loading power is over 1.1 times the rated power, the loading time must be limited within 3 seconds.**
 - **The transient over-power loading capability function only works once, i.e., you need to reset this function in the configuration menu after turning the input on and off.**
 - **The interval between the two over-power loading running must be up to 60 seconds.**
 - **When the loading power is over 1.1 times the rated power, the fan runs at full power.**
-

Refer to the following procedures to turn the transient over-power loading capability function on.

1. Press **[Shift]+[9]**(Config) to enter menu configuration(Config Menu).
2. Press Left/Right key to select “Enhance-Power”. Press **[Enter]** key.
3. Press Left/Right key to select “On”. Press **[Enter]** key.

3.8 Triggering Function

Triggering function is necessary to operate dynamic pulse output and list output. There are five triggering methods to trigger the tested instrument. Optional triggering sources of triggering function of electronic load comprise:

- Key trigger: when key trigger is valid, press **[Shift]+[.]** (Trigger) key and the load will trigger an operation.
- External trigger signal (TTL): Trig on the rear board is the triggering input terminal. When external trigger signal method is effective, after applying a low pulse (>10 us), the load will trigger an operation.
- Bus trigger: when the bus trigger is valid, after the load receives a trigger command (GET or * TRG), the load will trigger an operation.
- Timing trigger: when the timing trigger is valid, the load will automatically trigger an operation at intervals.
- Trigger holding: when trigger holding is valid, only when the load receives trigger command (TRIG:IMM), the load will trigger an operation.

Select the triggering sources as follows:

1. Press **[Shift]+[8]**(System) to enter system menu setting screen.

```
SYSTEM MENU
Initialize Power-On Buzzer
```
2. Press Left/Right key to move to the Trigger and press **[Enter]** to enter triggering source selection screen.

```
TRIGGER SOURCE
Manual(Def) External Hold
```
3. Press Left/Right key to select trigger method and press **[Enter]** to complete setting.

```
Manual (Def): manual trigger
External: external signal trigger
Hold: special command trigger
Bus: BUS command trigger
Timer: timer trigger
```
4. Press **[Esc]** to exit setting. The system displays original values under different modes.

3.9 Dynamic Test Function

Through dynamic test operation, the electronic load can be switched between two setting parameters based on setting rules. This function can be used to test dynamic performances of power supply. For dynamic test operation, press **[Shift] +[2]** (Tran) key on the front board to enter the dynamic test menu. Before test, firstly, set parameters related to dynamic test operation, including dynamic test mode, A value, B value, pulse width time, frequency, duty ratio, etc. Under CC mode, current ascending and descending slopes should be set for dynamic test.

The dynamic test mode can be divided into continuous mode, pulse mode and toggle mode.

3.9.1 Continuous Mode

Under continuous mode, after enabling dynamic test operation, the load will be switched continuously between A value and B value. The following picture shows the current waveform in continuous transient operation.

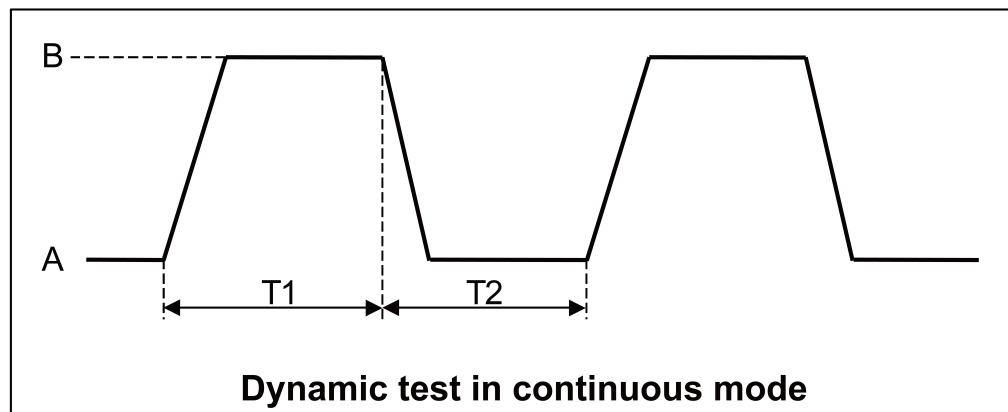

Taking CC mode as example (operations under other modes are similar), when output voltage and current of the tested instrument are 10 V and 3 A respectively, the load current will switch from 1 A and 2 A. Set the dynamic test parameters and perform the test as follows.

1. Press **[CC]** key to switch the load mode into CC mode.
2. Press **[Shift]+[2]**(Tran) keys. Operate Left/Right key and move to On. Press **[Enter]** key (The Trig lamp that indicates VFD screen status is on).

TRANSITION
On Off

3. Operate Left/Right key and select Continuous. Press **[Enter]** for confirmation.

CONTINUOUS

Continuous Pulse Toggle

- Operate Left/Right key and select high rate or low rate. Move to the High-Rate and press **[Enter]** key.

TRANSITION

High-Rate Low-Rate

- Set ascending slope and press **[Enter]** key.

TRANSITION

Rise up=2.0000A/uS

- Set descending slope and press **[Enter]** key.

TRANSITION

Fall Down=2.0000A/uS

- Set A value and press **[Enter]** key.

TRANSITION

Level A=1.00A

- Set B value and press **[Enter]** key.

TRANSITION

Level B=2.00A

- Set frequency value and press **[Enter]** key.

TRANSITION

Frequency=50.00HZ

- Set duty ratio and press **[Enter]** key.

TRANSITION

Duty=50.00% (0.01%-99.99%)

- Start dynamic test and operate Left/Right key. Move to On and press **[Enter]** key.

TRANSITION

On Off

- Enter the dynamic test mode.

0.00V 0.00A

0.0W 0 TRAN

- Press **[On/Off]** key to open input and press **[Shift]+[.]**(Trigger).

The load will continuously switch between A and B value. Time of operations is shown at bottom right.



Note

After the running count is up to 65535, it goes to zero and re-count, which doesn't affect the normal running of dynamic test.

14. Press **[CC]/[CV]/[CR]/[CW]** key or any composite function key to exit dynamic test function. Repeat Steps 1-13 to continue parameter setting and operation of dynamic test.

3.9.2 Pulse Mode

Under pulse mode, after enabling dynamic test operation, the load will switch to A value after receiving of a trigger signal. Then the load will switch back to B value and be constant at B value after maintaining A for pulse width time. The following picture shows the current waveform in pulse transient operation.

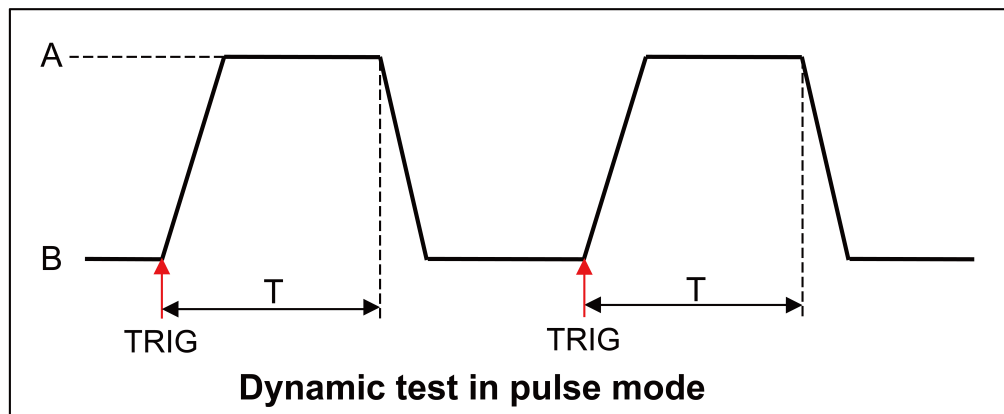

Taking CC mode as example (operations under other modes are similar), when output voltage and current of the tested instrument are 10 V and 3 A respectively, the load current will switch from 1 A and 2 A. Set the dynamic test parameters and perform the test as follows.

1. Press **[CC]** key to switch the load mode into CC mode.
2. Press **[Shift]+[2]**(Tran) keys. Operate Left/Right key and move to On. Press **[Enter]** key (The Trig lamp that indicates VFD screen status is on).

```
TRANSITION
On      Off
```

3. Operate Left/Right key and select Pulse. Press **[Enter]** for confirmation.

```
TRANSITION
Continuous Pulse Toggle
```

4. Operate Left/Right key and select high rate or low rate. Move to the High-Rate and press **[Enter]** key.

```
TRANSITION
High-Rate  Low-Rate
```

5. Set ascending slope and press **[Enter]** key.

```
TRANSITION
Rise up=2.0000A/uS
```

6. Set descending slope and press **[Enter]** key.

TRANSITION

Fall Down=2.0000A/uS

7. Set A value and press **[Enter]** key.

TRANSITION

Level A=1.00A

8. Set B value and press **[Enter]** key.

TRANSITION

Level B=2.00A

9. Set time width and press **[Enter]** key.

TRANSITION

Pulse Width=5.00000S

10. Start dynamic test and operate Left/Right key. Move to On and press **[Enter]** key.

TRANSITION

On Off

11. Enter the dynamic test mode.

0.00V 0.00A

0.0W 0 TRAN

12. Press **[On/Off]** key to open input and press **[Shift]+[.]**(Trigger) key.

The load will switch after receipt of every trigger signal. The load will continuously switch between A and B value. Time of operations is shown at bottom right.

13. Press **[CC]/[CV]/[CR]/[CW]** key or any composite function key to exit dynamic test function.



Note

Repeat Steps 1-12 to continue parameter setting and operation of dynamic test.

3.9.3 Toggle Mode

Under toggle mode with dynamic test function enabled, the load switches between A value and B value upon receiving a trigger signal, as shown in the following figure. The following picture shows the current waveform in toggle transient operation.

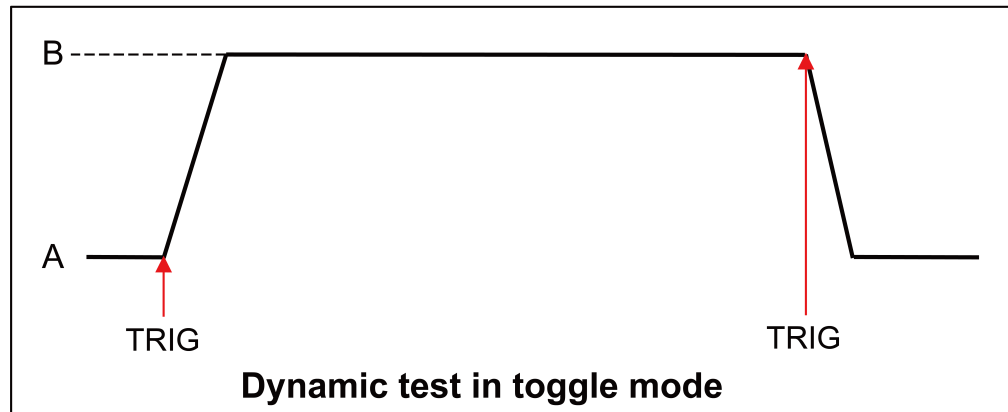

Taking CC mode as example (operations under other modes are similar), when output voltage and current of the tested instrument are 10 V and 3 A respectively, the load current will switch from 1 A and 2 A. Set the dynamic test parameters and perform the test as follows.

1. Press **[CC]** key to switch the load mode into CC mode.
2. Press **[Shift]+[2]**(Tran) keys. Operate Left/Right key and move to On. Press **[Enter]** key (The Trig lamp that indicates VFD screen status is on).

```
TRANSITION
On      Off
```

3. Operate Left/Right key and select Toggle. Press **[Enter]** for confirmation.

```
TRANSITION
Continuous  Pulse  Toggle
```

4. Operate Left/Right key and select high rate or low rate. Move to the High-Rate and press **[Enter]** key.

```
TRANSITION
High-Rate  Low-Rate
```

5. Set ascending slope and press **[Enter]** key.

```
TRANSITION
Rise up=2.0000A/uS
```

6. Set descending slope and press **[Enter]** key.

```
TRANSITION
Fall Down=2.0000A/uS
```

7. Set A value and press **[Enter]** key.

```
TRANSITION
Level A=1.00A
```

8. Set B value and press **[Enter]** key.

```
TRANSITION
Level B=2.00A
```

9. Start dynamic test and operate key. Move to on and press **[Enter]** key.

TRANSITION

On Off

10. Enter the dynamic test mode.

```

0.00V      0.00A
0.0W      0 TRAN
    
```

 11. Press **[On/Off]** key to open input and press **[Shift]+[.]**(Trigger) key.

The load will switch after receipt of every trigger signal. The load will switch between A and B value for one time. Time of operations is shown at bottom right.

 12. Press **[CC]/[CV]/[CR]/[CW]** key or any composite function key to exit dynamic test function.

Note

Repeat Steps 1-11 to continue parameter setting and operation of dynamic test.

3.10 OCP Test Function

This series electronic load is provided with over-current protection test function (OCP Test). Under OCP test mode, when input voltage reached Von value, delay for a while for the electronic load to latch. Ascend value by step value at regular interval. At the same time, check the load input voltage and judge whether it is higher than standard voltage value. If higher, it indicates that OCP does not occur. Repeat current stepping operation till the load operates to the cutoff current; if lower, it indicates that OCP does occur. Check whether the existing current value is within target scope again. If yes, PASS the test.

Operating steps:

 1. Press **[Shift]+[CC]**(OCP) keys to enter OCP test function setting screen.

OCP TEST	Run	OCP TEST	
			Operate OCP test documents.
	Recall	OCP TEST	
		Recall OCP File=1	Recall OCP test documents (1-5).
	Edit	OCP TEST	
		1 : Voltage on level=0.00V	Set Von voltage value.
		2 : Voltage on Delay=0.00S	Set Von voltage delay time.
		3 : Current Range=0.000A	Set working current range.
		4 : Start Current=0.000A	Set initial current value.
		5 : Step Current=0.000A	Set step current value.

		6 : Step Delay=0.00S	Set step delay time.
		7 : End Current=0.000A	Set cutoff current value.
		8 : OCP Voltage=0.000V	Set OCP value.
		9 : Max Trip Current=0.000A	Set overcurrent range (maximum value).
		10 : Min Trip Current=0.000A	Set overcurrent range (minimum value).
		Save OCP File=1 (1-5)	Save OCP test documents.

2. Press **[Shift]+[.]**(Trigger) key to start OCP test. If within range, pass the test and the board will display as follows:

```

9.97V          0.005A
0.010W   5.100A Pass   Stop
    
```

If not, there is FAULT and the board will display as follows:

```

9.97V          0.005A
0.010W   5.100A Fault Stop
    
```

3. End test. Press **[Esc]** to return to setting screen. Press **[Esc]** again to exit.

3.11 OPP Test Function

This series electronic load is provided with overpower protection test function (OPP Test). Under OPP test mode, when input voltage reached Von value, delay for a while for the electronic load to latch. Ascend value by step value at regular interval. At the same time, check the load input voltage and judge whether it is higher than standard voltage value. If higher, it indicates that OPP does not occur. Repeat power stepping operation till the load operates to the cutoff power; if lower, it indicates that OPP does occur. Check whether the existing power value is within target scope again. If yes, PASS the test.

Operating steps:

1. Press **[Shift]+[CW]**(OPP) keys to enter OPP test function setting screen:

OPP TEST	Run	OPP TEST	
			Operate OPP test documents.
	Recall	OPP TEST	
		Recall OPP File=1	Recall OPP test documents (1-5).
	Edit	OPP TEST	
		1 : Voltage on level=0.00V	Set Von voltage value.
2 : Voltage on Delay=0.00S		Set Von voltage delay time.	

	3 : Current Range=0.000A	Set current range.
	4 : Start Power=0.00W	Set initial power value.
	5 : Step Power=0.00W	Set step power value.
	6 : Step Delay=0.00S	Set step delay time.
	7 : End Power=0.00W	Set cutoff power value.
	8 : OPP Voltage=0.000V	Set OPP value.
	9 : Max Trip Power =0.00W	Set overpower range (maximum value).
	10 : Min Trip Power =0.00W	Set overpower range (minimum value).
	Save OPP File=1 (1-5)	Save OPP test documents.

- Press **[Shift]+[.]**(Trigger) key to start OPP test. If within range, pass the test and the board will display as follows:

```

9.97V                0.007A
0.010W   49.1W Pass  Stop
    
```

If not, there is FAULT and the board will display as follows:

```

9.99V                0.007A
0.01W   48.6W Fault Stop
    
```

- End test. Press **[ESC]** to return to setting screen. Press **[ESC]** again to exit.

3.12 Battery discharge test function

In this series electronic load, constant current mode is applied for discharge test with programmatic setting of stop voltage/capacity/discharging time. If stop voltage is set as the stop condition, the system determines whether the battery is about to reach the set threshold value or unsafe status when the battery voltage is low, and if yes, an automatic stop will be activated. During test, the operator can observe voltage, discharging time and discharged capacity of battery. Battery discharge test is a necessary step before battery replacement for it can reflect reliability and remaining life of battery.

WARNING

When using switch-type devices to directly connect the test object and electronic load, there will be a voltage surge at the moment the switch device is closed. The excessively high voltage surge will damage the electronic load. To avoid loading the load with a high voltage surge, it is recommended to connect a current-limiting resistor in series in the circuit. When the test current is less than 400A, the IT-E165A module can be directly connected in series. The IT-E165A module is an optional accessory and needs to be purchased separately. The connection method for IT-E165A is detailed in reference [Connect the IT-E165A](#), and the method for connecting a series current-limiting resistor is detailed in reference [Precautions for connecting batteries](#).

Operation steps

1. Press **[On/Off]** key to cut off load input status. Connect the battery to be tested.
2. Press **[CC]** key to switch the load mode into CC mode.
3. Press **[Shift]+[5]**(Battery) keys to enter battery discharge function menu.
4. Set stop voltage and press **[Enter]** key.

Stop Voltage=0.0V

When the battery voltage drops to stop voltage, the load input status will automatically be Off.

5. Set battery stop capacity and press **[Enter]** key.

Stop Capacity=0.000Ah

When set battery capacity is reached, the load input status will automatically be Off.

6. Set discharge time and press **[Enter]** key.

Stop Timer=99999S

When the set stop time is reached, the load input status will automatically be Off.

7. Press **[Shift]+[.]**(Trigger) key to start test. The board will display discharge voltage, current discharge time and discharged capacity (Ah).

0.01V 0.00A

0.00W 0S 0.000Ah

8. Press **[Esc]** key to exit battery capacity test mode.

Precautions for connecting batteries

When using switch-type devices to directly connect the test object and electronic load, there will be a voltage surge at the moment the switch device is closed. The excessively high voltage surge will damage the electronic load. To

avoid equipment damage, it is recommended to use the following wiring method in battery discharge testing to ensure the safe operation of the testing equipment.

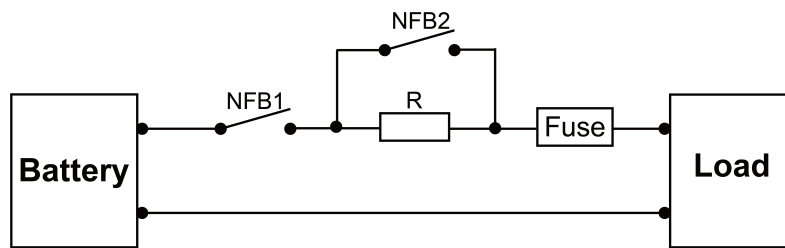

Instructions:

- NFB: Non-fused switch, used to cut the circuit in time when the load is aging short circuit inside. The current flow of the non-fused switch must be less than the maximum current flow of the battery.
- R: Current limiting resistor, which is used to prevent the inrush current of the battery from being too high due to the RC of the load port when the NFB1 is sucked in, thus protecting the battery to be tested from damage. It also prevents the parasitic inductance on the test lead from resonating with the RC of the load port at the moment of relay suction, resulting in excessive voltage received at the load end, thus avoiding damage to the electronic load. It is recommended that the resistance value of the current limiting resistor is greater than 100kΩ.
- Fuse: Fuse, when the current abnormally rises to a certain height and heat, it melts itself to cut off the current, protecting the safe operation of the circuit. The rated current value of the fuse must be 150%~200% of the maximum discharge current of the battery.

Operation instructions:

- Start Discharging
First, connect the electronic load and the battery according to the diagram. Then, close switch NFB1. After a delay of 5 seconds, close switch NFB2 to begin the battery discharge test.
- Stop Discharging
First, press the **[On/Off]** key on the load front panel to turn off the load input. Then, disconnect switch NFB2. Finally, disconnect switch NFB1 to stop the battery discharge test.

3.13 CR-LED test function

With adding of diode break-over voltage setting in this series electronic load under conventional CR mode, the electronic load only works when voltage applied at its both ends is higher than the diode break-over voltage to give a real simulation of diode working principle, i.e., the ripple current at real LED test.

The I-V curve of LED is as shown below. Under conventional CR mode, the electronic load only simulates the static working point of diode as shown in the red circle of the following figure. It is unable to verify the dynamic characteristics of LED under normal working conditions, and the status of accurate ripple current.

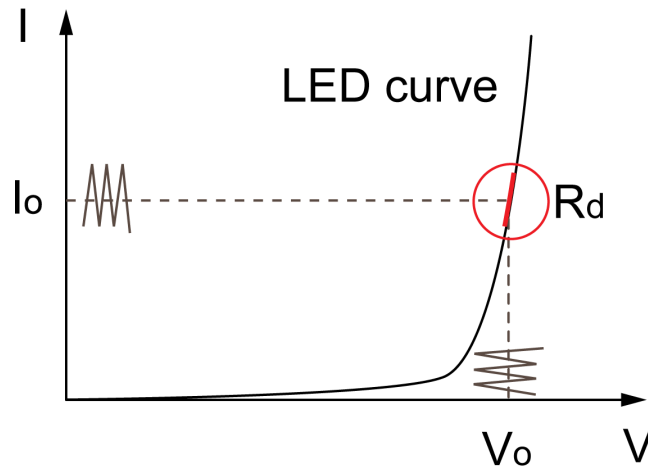

The definitions of parameters shown in the above figure are as follows:

- V_o : constant working voltage of load LED of LED constant current source;
- I_o : output current of LED constant current source;
- V_d : break-over voltage of diode (string);
- R : constant resistance.

Setting CR-LED Mode

Example: LED driver specification

The output current is 200mA and the range of output voltage is from 45V to 62V.

1. Start CR-LED function.
 - a. Press **[Shift]+[9]**(Config) keys to enter configuration menu.
 - b. Press Right Key and select "CR-LED". Press **[Enter]** key for entry. Select "on" and press **[Enter]** key.
 - c. Press **[Esc]** key to exit.
2. Set CR mode and V_d value.

For example, the output voltage of LED driver is 50V, verify that whether the output current of LED is rated current 200mA.

- a. Press **[CR]** key and set corresponding constant resistance. (Set CR=50 Ω)
- b. Press **[Shift]+[CV]**(Setup)keys for a series of related setting:
range=7500.0

high=130V

low=0V

which may remain the original values. V_d will be set based on the calculation below. (Set $V_d=40V$)

- c. Press the **[Enter]** key to save the settings.
3. Press **[On/Off]** key to turn on load input.

Calculation method of V_d and R

Definition:

- V : constant working voltage of load LED of LED constant current source;
- I : output current of LED constant current source;
- V_d : break-over voltage of diode (string);
- R : constant resistance.

V-I curve of LED is as shown below.

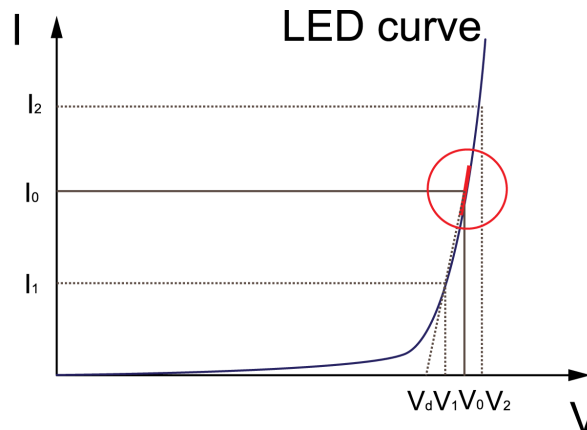

According to four parameters above and the V-I curve of LED, you can calculate the value of R and V_d .

$$R = \frac{V_2 - V_1}{I_2 - I_1}$$

$$V_d = V_0 - (I_0 \times R)$$



Note

The value of V_2 , V_1 , I_2 and I_1 should be close to the static working point of LED as shown in the red circle above.

Or you can calculate the value of R and V_d by the following method.

$$V_d = V \times 0.8$$

$$R = 0.2V / I$$

In the example:

$$V_d = 50V \times 0.8 = 40V$$

$$R = (0.2 * 50V) / 0.2A = 50\Omega$$

3.14 Measure Function

This series load provide measure function, mainly used for measuring the rising and falling time of voltage or current within a specified range.

Operation methods

1. Connect the instruments.
Connect DC power to be tested to the input terminal of the electronic load.
2. Set the output parameters of the power supply.
 - a. The power is set with a value that is higher than the set high voltage/current value.
 - b. Keep power output in Off status.
3. Set the low and high voltage/current comparison points' value for electronic load.
 - a. Press **[Shift]+ [9]**(Config) keys to enter configuration menu. Press Right key. Select "Measure" and press **[Enter]** key.
 - b. Press Left/Right to select "Time V". Press **[Enter]** key.
 - c. Press Left/Right key to select "Low". Press **[Enter]** key. Press numeric keys to set low voltage value and press **[Enter]** key.
 - d. Press Left/Right key to select "High". Press **[Enter]** key. Press numeric keys to set high voltage value and press **[Enter]** key.
 - e. Press **[Esc]** key to exit the voltage comparison points setting menu.
 - f. Press Left/Right to select "Time C". Press **[Enter]** key.
 - g. Press Left/Right key to select "Low". Press **[Enter]** key. Press numeric keys to set low current value and press **[Enter]** key.
 - h. Press Left/Right key to select "High". Press **[Enter]** key. Press numeric keys to set high current value and press **[Enter]** key.
 - i. Press **[Esc]** to exit setting.
4. Open the load input.
5. Open power output.
6. Use the following commands to read the voltage rising time, current rising time, voltage positive pulse time and current positive pulse time, when the power supply output is stable.

```
SENSe:TIME:VOLTage:UP?
SENSe:TIME:CURRent:UP?
SENSe:VOLTage:POSitive:PULSe?
SENSe:CURRent:POSitive:PULSe?
```
7. Close the power output.

8. Use the following commands to read the voltage falling time, current falling time, voltage negative pulse time and current negative pulse time, when the power supply output is stable.

SENSe:TIME:VOLTage:DOWN?

SENSe:TIME:CURRent:DOWN?

SENSe:VOLTage:NEGative:PULSe?

SENSe:CURRent:NEGative:PULSe?

3.15 Configuration Save Function

The electronic load can save some commonly-used parameters in 100-group NVM for convenient and fast usage. The **[Shift]+[4]**(Save) keys can be used for saving parameters. The **[Shift]+[Enter]**(Recall) key is for quick invoking.

The parameters to be saved includes :

- Operation modes for the electronic load (CC/CV/CR/CW);
- The setting parameters under the four constant-status operation modes;
- The setting parameters in the configuration menu.

Memory Function

When you want to recall the data saved in the memory, you should set memory group in the system menu first. Group 0 means you can recall data saved in 0 to 10 groups. Group 1 means you can recall data saved in 11 to 20 groups. Group2 to Group 9 can be concluded in the same manner.

Save Operation

If the operator needs to save configured parameter values for direct recall in follow-up operation, refer to the steps below:

E.g., power supply 6V and 3A. The electronic load works under constant current (CC) 1A. Save "CC 1A" in register 39 for recall.

1. Set the parameters ok (CC 1A), and press **[Enter]**.

5.89V 0.99A

5.89W CC= 1.00A

2. Press **[Shift]+[4]**(Save) to save the instrument's settings to a register.

5.89V 0.99A

5.89W Save: 1

3. Enter number **[3]** and **[9]**, indicates the settings is saved in the 9th register in Group3.

```
5.89V      0.99A
5.89W   Save: 39
```

4. Press **[Enter]** key.

```
5.89V      0.99A
5.89W   CC= 1.00A
```

Recall Operation

1. Set the memory group number. If the group number has been set to 3 already, you can skip this step.
 - a. Press the composite key **[Shift]+[8]**(System) to enter system menu setting screen.
 - b. Operate Left/Right key and move to the Memory and press **[Enter]** key.
 - c. Set the value of Group to **[3]**, the interface displayed as follows.

```
MEMORY
GROUP=3
```

- d. Press **[Enter]** to confirm the setting.
- e. Press **[Esc]** to return to home screen.

```
5.89V      0.00A
0.00W   CC= 0.00A
```

2. Press **[Shift]+[Enter]**(Recall) to execute the data recalling operation.

```
5.89V      0.00A
0.00W   Recall: 1
```

3. Enter number **[9]**, indicates the data saved in the 9th register in Group3 is recalled.

```
5.89V      0.00A
0.00W   Recall: 9
```

4. Press **[Enter]** to confirm and recall the stored data.

```
5.89V      0.99A
5.89W   CC=1.000A
```

3.16 VON Function

When testing some power products with slow voltage rise speed, if the electronic load input is opened before power, the power may latch protection. In this way, the user may set VON value. The electronic load only latches when power voltage is higher than this value.

Press **[Shift] + [9]**(Config) keys to enter configuration menu. Set voltage value in Voltage on under configuration menu to control On/Off status of electronic load. Based on Von value load and unload, the load has two modes: Living and

Latch. When Living is selected, it indicates that the work load point is in living status; when Latch is selected, it indicates that the work load point is in latch load status.



Note

Please confirm whether it is necessary to set loading voltage, a step that provides convenience for limiting working voltage value. If not necessary, do not set the loading voltage without authorization to prevent unnecessary trouble from failure of loading.

If the instrument cannot load, please firstly check whether the VON function is set. If yes, reset the Von value to minimum value (which may be directly set as 0. If minimum voltage value of instrument is not 0, press 0 for confirmation and the menu will automatically set the value as minimum value).

- When VON LIVING function is started, the load starts load test only when the power voltage rises and is higher than Von Point loading voltage. When the power voltage drops and is lower than Von Point unloading voltage, the load will not unload.

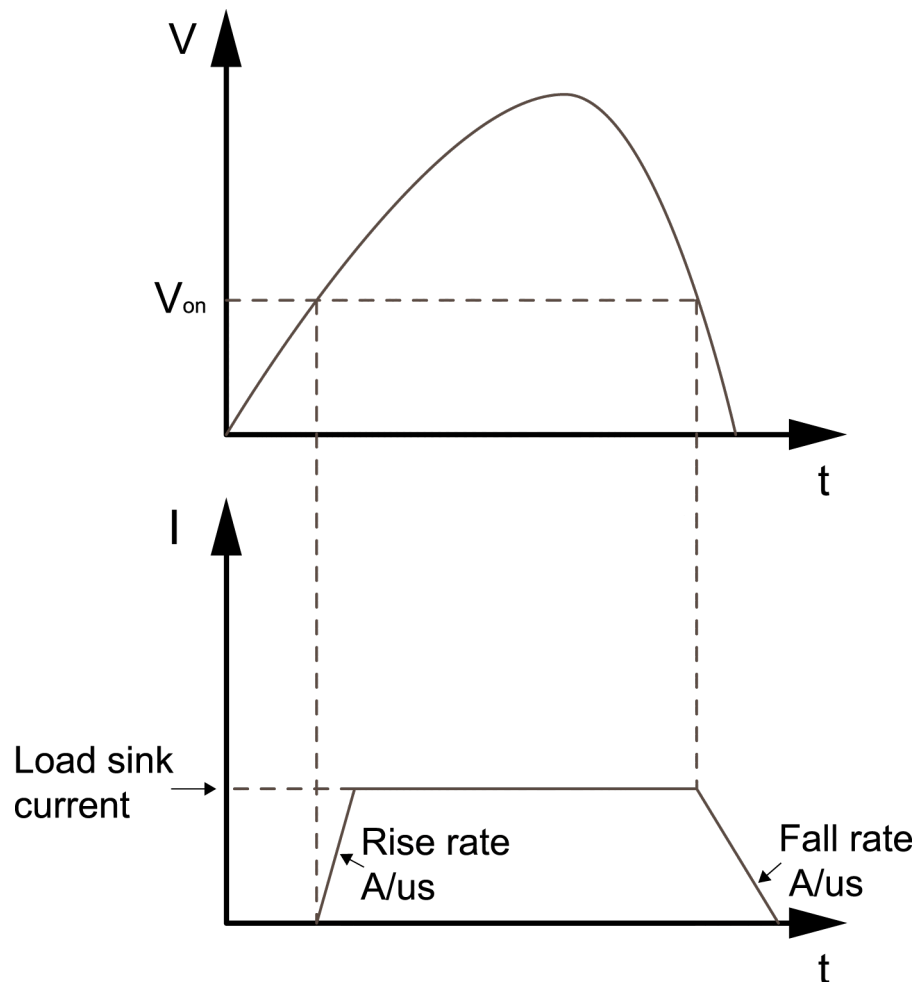

Load working range when VON LIVING is started

- When VON LATCH function is started, the load starts load test only when the power voltage rises and is higher than Von Point loading voltage. When the power voltage drops and is lower than Von Point unloading voltage, the load will not unload.

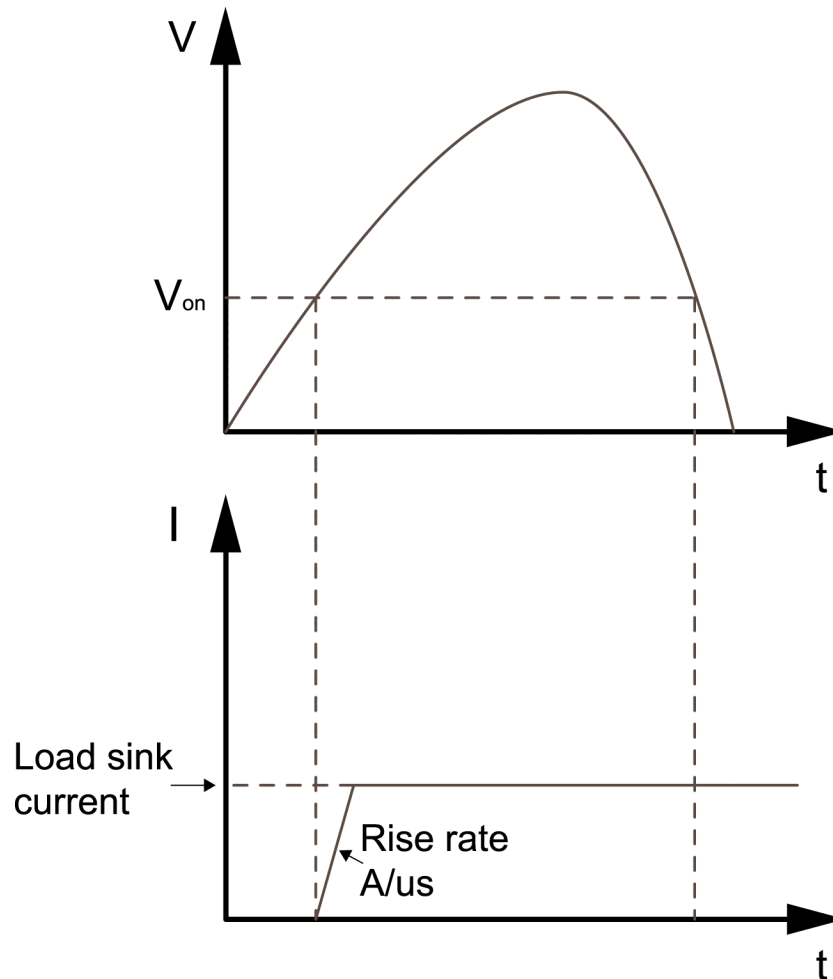

Load working range when VON LATCH is started

3.17 Protective Function

The load is provided with following protective functions: overvoltage protection (OVP), overcurrent protection (OCP), overpower protection (OPP), overtemperature protection (OTP) and current oscillation protection (OSC).

3.17.1 Overvoltage Protection (OVP)

- **Overvoltage protection:** The load will be immediately Off and the buzzer will sound if the overvoltage circuit is triggered. OV and VF bits of the status register will be set and OVP will be displayed on the screen of the load till resetting.
- **Clear overvoltage protection status:** Inspect whether voltage of object under test is within load rated voltage or set protection voltage range. If not, disconnect the object. Press any key on load front board (or send command PROTECTION:CLEAR), the load front board (OVP) word will get cleared and the load will exit OVP protection status.

3.17.2 Overcurrent Protection (OCP)

The electronic load is provided with two kinds of overcurrent protections: hardware overcurrent protection and software overcurrent protection.

- **Hardware overcurrent protection:** maximum load current of the electronic load is limited within about 110% of the existing current range by hardware. When the hardware triggers overcurrent protection, OC bit of the status register will be set; when such protection is removed, the OC bit will be reset. The On/Off status of load will not be changed by the hardware overcurrent protection.
- **Software overcurrent protection:** When software overcurrent protection function is on, if the loading current value exceeds delay of such overcurrent protection set value, the load will automatically be Off and the VFD will display **Over current !**. At the same time, OC and PS bits of the status register will be set and keep till reset.

Set the OCP current value as follows:

1. Press the composite key **[Shift]+[9]**(Config) to enter configuration menu setting screen.
 2. Press Left/Right key to move to the Protect and press **[Enter]**.
 3. Press Left/Right key to move to the I-Limit and press **[Enter]**.
 4. Press Left/Right key to move to the On and press **[Enter]**.
 5. Press numeric keys and set the OCP Point, press **[Enter]** to confirm.
 6. Press numeric keys and set the Delay time, press **[Enter]** to confirm.
 7. Press **[Esc]** to exit setting.
- **Clear overcurrent protection status:**Inspect whether current of object under test is within load rated current or set protection current range. If not, disconnect the object. Press any key on load front board (or send command PROTECTION:CLEAR), the load front board (OCP) word will get cleared and the load will exit OCP protection status.

3.17.3 Overpower Protection (OPP)

The electronic load is provided with two kinds of overpower protections: hardware overpower protection and software overpower protection.

- **Hardware overpower protection:**the user can set load hardware overpower protection. Load overpower will be limited to existing power value. The On/Off status of load will not be changed by the hardware overpower protection.

Set the Max-P Point as follows:

1. Press the composite key **[Shift]+[9]**(Config) to enter configuration menu setting screen.
2. Press Left/Right key to move to the Protect and press **[Enter]**.
3. Press Left/Right key to move to the Max-P and press **[Enter]**.
4. Press numeric keys and set the Max-P Point, press **[Enter]** to confirm.

5. Press **[Esc]** to exit setting.
- **Software overpower protection:** If the loading power value exceeds delay of such overpower protection set value, the load will automatically be OFF and the VFD will display **Over power !**. At the same time, OP and PS bits of the status register will be set and keep till reset.
Set the OPP Power value as follows:
 1. Press the composite key **[Shift]+[9]**(Config) to enter configuration menu setting screen.
 2. Press Left/Right key to move to the Protect and press **[Enter]**.
 3. Press Left/Right key to move to the P-Limit and press **[Enter]**.
 4. Press numeric keys and set the OPP Point, press **[Enter]** to confirm.
 5. Press numeric keys and set the Delay time, press **[Enter]** to confirm.
 6. Press **[Esc]** to exit setting.
 - **Clear overpower protection status:** Inspect whether power of object under test is within load rated power or set protection power range. If not, disconnect the object. Press any key on load front board (or send command to PROTECTION:CLEAr), the load front board (OPP) word will get cleared and the load will exit OPP protection status.

3.17.4 Overtemperature Protection (OTP)

- **Overtemperature protection:** When internal power device of load is higher than about 85 °C, the load is under temperature protection. At this time, the load will automatically be OFF and VFD will display OTP. At the same time, OT and PS bits of the status register will be set and keep till reset.
- **Clear overtemperature protection:** When load temperature is decreased to protection point, press any key on load front board (or send command to PROTECTION:CLEAr), the load front board (OTP) word will get cleared and the load will exit OTP protection status.

3.17.5 Current Oscillation Protection(OSC)

- **Current oscillation protection:** When the load-on current and the current change frequency exceed a certain limit during the loading process, the current oscillation protection will be triggered. If current oscillation protection is triggered, the load will automatically be Off and the VFD will display “OSC protect!”. At the same time, OSC and PS bits of the status register will be set and keep till reset.
- **Clear current oscillation protection status:** Press any key on load front board (or send command to PROTECTION:CLEAr), the load front board (OSC) word will get cleared and the load will exit OSC protection status.

3.18 List Operation

LIST mode provides an accurate, fast and low-cost way to complete any complicated current change mode, which enables synchronization of internal or external signals in multiple quasi-bit load precision tests.

When different trigger sources are selected, the LIST function will form a variety of complex sequences by editing step value, pulse width and slope of each step to meet complicated test requirements. LIST parameters comprise designation of input list file, input step count (2 to 84 steps), step time (0.00002S to 3600S) as well as setting value and slope of each step. The list file can be stored in non-volatile RAM available for a quick output in case of usage. The user can edit 7 groups of list files at maximum.

If the load operation mode is at List operation, the load will start List operation when it receives a trigger signal till completion or receipt of another trigger signal.

Before List operation, be sure to edit List operation files and save them in load non-volatile RAM. Refer to examples below to know how to execute List operation through board. It is assumed that output voltage and current of the tested instrument are 10V and 3A respectively and the load is under CC mode.

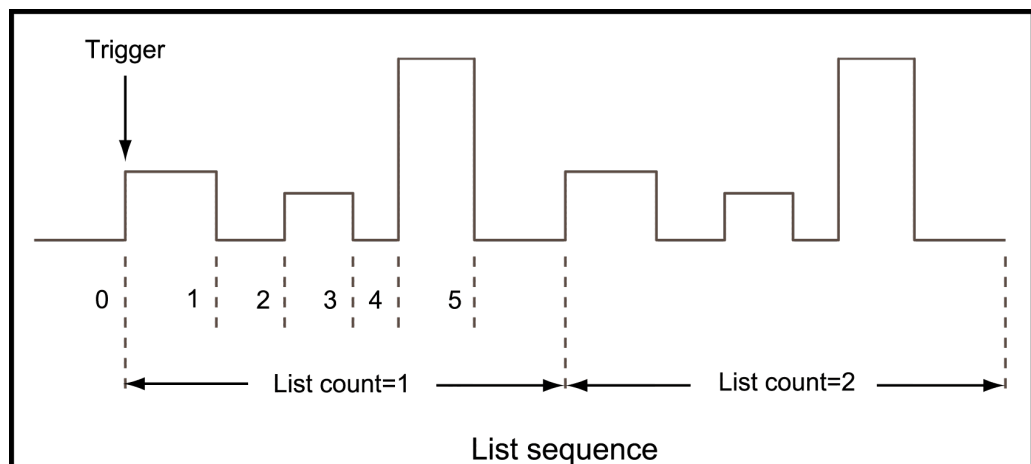

Operation steps

- Press **[Shift]+[3]**(List) keys. Operate Left/Right key and move to Edit. Press **[Enter]** key.
LIST
Off Recall Edit
- Operate Left/Right key and move to the High-Rate and press **[Enter]** key.
EDIT LIST
High-Rate Low-Rate
- Set maximum working current value and press **[Enter]** for confirmation.
EDIT LIST

- Current Range=5.000A
4. Edit number of steps. Press **[2]** key to edit two steps. Press **[Enter]** key.
 EDIT LIST
 File Step=2 (2-80)
 5. Edit current value in step 1 and press **[Enter]** key.
 EDIT LIST
 Step 01 Level=0.0002A
 6. Edit slope in step 1 and press **[Enter]** key.
 EDIT LIST
 Step 01 Rate=0.0010A/mS
 7. Edit time in step 1 and press **[Enter]** key.
 EDIT LIST
 Step 01 Width=0.00002S
 8. Edit current value in step 2 and press **[Enter]** key.
 EDIT LIST
 Step 02 Level=2.0000A
 9. Edit slope in step 2 and press **[Enter]** key.
 EDIT LIST
 Step 02 Rate=1.0000A/mS
 10. Edit time in step 2 and press **[Enter]** key.
 EDIT LIST
 Step 02 Width=3600.00000S
 11. Edit repeat count and press **[Enter]** key.
 EDIT LIST
 Repeat Count=2 (1-65535)
 12. Save all edited files and press **[Enter]** key.
 EDIT LIST
 Save List File=1 (1-7)
 13. Operate Left/Right key and move to on. Press **[Enter]** key (The Trig lamp that indicates VFD screen status is on). Press **[Esc]** key to exit setting.
 LIST
 On Recall Edit
 14. Press **[On/Off]** key to open input and press **[Shift]+[.]**(Trigger)key.
 0.00V 0.00A
 0.0W 0 LIST1
 15. Press **[CC]/[CV]/[CR]/[CW]** key or any composite function key to exit List test function.

Note

If On Recall Edit is displayed under LIST MENU or the external analog control function is switched on, neither List nor Wave file editing is accessible. In this case, change On Recall Edit to Off Recall Edit before operation.

For direct recall of existing List files and triggering of List operation, refer to steps below:

Operation steps

1. Press **[Shift]+[3]**(List) keys. Operate Left/Right key and move to Recall. Press **[Enter]** key.

```
LIST
Off Recall Edit
```
2. Select edited files and press **[Enter]** for confirmation.

```
RECALL LIST
Recall List File=1
```
3. Operate Left/Right key and move to on. Press **[Enter]** key (The Trig lamp that indicates VFD screen status is on). Press **[Esc]** key to exit setting.

```
LIST
On Recall Edit
```
4. Press **[On/Off]** key to open input and press **[Shift]+[.]**(Trigger) key .
 List operation.

3.19 Terminal Function of Rear Panel

Terminals on this series load rear panel comprise external trigger terminal, external analog control terminal, voltage fault indication terminal, external On/Off control terminal and current monitoring terminal. Terminal schematic (as shown below):

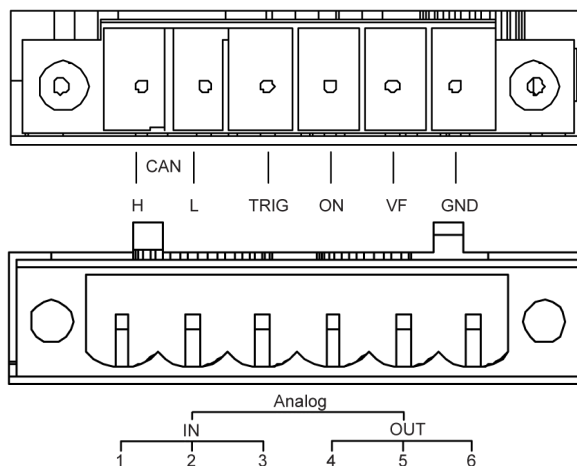

Pin	Pin function
CAN_H , CAN_L	CANH and CANL terminal for CAN communication. (- Incomplete support)
TRIG	Positive input signal terminal for external trigger.

Pin	Pin function
ON	Positive input terminal for external On/Off control.
VF	Positive output terminal for voltage fault indication.
GND	Negative terminal for TRIG, ON and VF.
Analog	Analog input/output signal terminals, used as analog signal for parallel-connection. Analog1: input GND; Analog2: input differential –; Analog3: input differential +; Analog4: output GND; Analog5: output differential –; Analog6: output differential +;
Ext_PRG–, Ext_PRG+ (reuse the Analog input/output signal terminals)	Ext_PRG–: connect terminals Analog1 and Analog2 as a reuse terminal. Ext_PRG+: terminal Analog3.

3.19.1 External Trigger Function

When rear board triggering mode is selected, firstly, set the trigger source as External and the triggering signal is input from the rear board TRIG terminal.

When external trigger is selected, the positive and negative TRIG terminals will generate trigger signal and the low pulse is valid. Input corresponding to one trigger can be used for triggering dynamic test, LIST test and auto test.

The user can make the setting in the system menu as the following procedures.

1. Press **[Shift] + [8]**(System) keys to enter system menu.
2. Press Left/Right key to move to the Trigger and press **[Enter]**.
3. Press Left/Right key to move to the External and press **[Enter]**.
4. Press **[Esc]** to exit the menu.

3.19.2 External On/Off Control

The load input switches can be controlled by the external TTL electrical level. During external input control, the **[On/Off]** key will become invalid and the load input switches can only be controlled by the external TTL electrical level. The load input will be switched on in case of low level external input; and the load input will be switched off in case of high level external input.

3.19.3 Voltage Fault Indication

When load is under overvoltage protection , VF pin voltage fault indication terminal outputs high level.

3.19.4 External Analog Function

Parallel-Connection Analog Function

Analog input/output signal terminals are on the rear panel, used as analog signal for parallel-connection. Please refer to Parallel Function for detailed description.

External Analog Control Function

Loading current of the electronic load can be controlled by Ext_PRG (\pm) analog quantity terminals on rear board. Connect 0 to 10V adjustable voltage at the Ext_PRGG terminal to analog input from 0 to full range so as to adjust input current of load (10V corresponds to current of load at full range).

The setting method as follows:

1. Press **[Shift]+[9]**(Config) to enter configuration menu(Config Menu).
2. Operate Left/Right key and select Ext-Program. Press **[Enter]** key.
3. Select ON and start external analog control function.
4. Press **[Esc]** to exit the menu and the screen displays Rear.

Connect the terminals as follow.

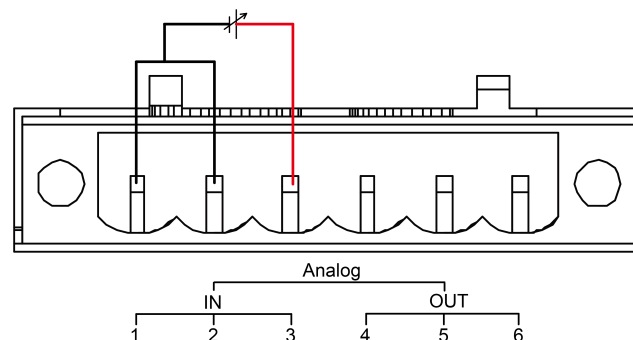

3.19.5 Current Monitoring (I Monitor)

The 0 to 10V analog quantity output signal of current monitoring output terminal represents input current to which the terminal belongs from 0 to full range. An external voltmeter or oscilloscope can be connected to display input current change.

3.20 Auto Test Function

This series electronic load has a very strong automatic test function. The automatic test function is useful for simulating various tests and allows the user to edit up to 10 groups of testing files. It helps engineers to test out all kinds of data of the tested power supply at different loading status. Automatic test function can edit multiple product tests, such as CC, no-load, short-circuit, CV, so it can finish all test by one time. It makes tests convenient and fast, and ensures high efficiency and testing accuracy.

Edit test files

1. Press **[Shift]+[6]**(Prog) keys.
 PROGRAM
 Run Recall Edit
2. Operate Left/Right key and move to Edit. Press **[Enter]** key to enter editing test files.
 EDIT PROGRAM
 Active Sequence=0987654321
3. Press numeric key to select test step and press **[Enter]** key. Active Sequence= 09876543YY (indicating that 1/2 step has been selected).
 EDIT PROGRAM
 Active Sequence=09876543YY
4. Select whether pause is necessary for these two steps. If step 2 is to be paused, press **[2]** key. If not, directly press **[Enter]** key.
 EDIT PROGRAM
 Pause Sequence=□□□□□□□Y1
5. Select whether short-circuit test is necessary for these two steps. If step 1 is to be tested, press **[1]** key. If not, directly press **[Enter]** key.
 EDIT PROGRAM
 Short Sequence=□□□□□□□2Y
6. Set loading time of step 1. If 2S is required, directly press **[2]** key on the board. Press **[Enter]** key.
 EDIT PROGRAM
 SEQ 01 On Time=2.0S
7. Set unloading time of step 1. If 2S is required, directly press **[2]** key. Press **[Enter]** key.
 EDIT PROGRAM
 SEQ 01 Off Time=2.0S
8. Set test delay time of step 1. If 1S is required, directly press **[1]** key. Press **[Enter]** key. Tpf is delay time before measurement.
 EDIT PROGRAM
 SEQ 01 P/F Delay Time=1.0S
9. Set loading time of step 2. If 2S is required, directly press **[2]** key. Press **[Enter]** key.

```
EDIT PROGRAM
SEQ 02 On Time=2.0S
```

10. Set unloading time of step 2. If 2S is required, directly press **[2]** key. Press **[Enter]** key.

```
EDIT PROGRAM
SEQ 02 Off Time=2.0S
```

11. Set test delay time of step 2. If 1S is required, directly press **[1]** key. Press **[Enter]** key. T_{pf} is delay time before measurement.

```
EDIT PROGRAM
SEQ 02 P/F Delay Time=1.0S
```

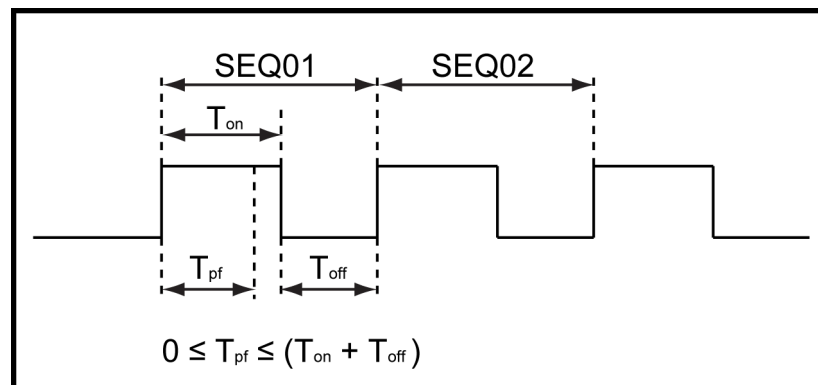

12. Set conditions for stop test. Complete means to stop after all tests are completed and Failure means to stop in case of test error. Press **[Enter]** key.

```
PROGRAM
Complete-Stop Failure-Stop
```

13. Determine whether to link to next group of test file. If it is to link to second group, press **[2]** key. 0 means not to link to other test files. Press **[Enter]** key.

```
PROGRAM
Chain Program File=0(0-10)
```

14. Save the programmed files in EEPROM. A total of 10 groups of files can be saved. If it is to save edited files in group 2, press **[2]** key. Press **[Enter]** key.

```
PROGRAM
Save Program File=2(1-10)
```

15. Press **[Esc]** key to exit editing menu.

Note

In the following editing procedures, "Y" indicates selected status. To cancel selected status, press numeric key of corresponding step again. The above steps only set entire framework of auto tests. Additional setting is required for specific parameters in each step. This design will facilitate modification of parameters in a single step.

Edit Auto Test Step Parameter

After setting of entire structure of auto test, settings at each step should be independently saved. Take CC and CV mode as an example to describe how to edit auto test step parameters as below. The step editing methods of CR and CW modes are similar.

It is assumed that step 1 edits CC mode as follows: current: 2A, maximum voltage value: 10V, and minimum voltage value: 2V.

1. Press the **[CC]** key to set the current value as 2A. Press the **[Shift] + [CV]** (-Setup) keys to enter the parameter setting page.

```
Constant Current
Range=240.00A
```

2. Set the maximum working current value, and enter the **[Enter]** key.

```
Constant Current
Range =200.00A
```

3. Set the maximum voltage value, and enter the **[Enter]** key.

```
Constant Current
High=10.0V
```

4. Set the minimum voltage value, and enter the **[Enter]** key.

```
Constant Current
Low=2.0V
```

5. Select the high or low rate, and enter the **[Enter]** key.

```
Constant Current
High-Rate Low-Rate
```

6. Set the current rising slope, and enter the **[Enter]** key.

```
Constant Current
Rise up=2.0000A/mS
```

7. Set the current falling slope, and enter the **[Enter]** key.

```
Constant Current
Fall down=2.0000A/mS
```

After the parameter settings are complete, the page is shown as follows.

```
0.00V      0.00A
0.00W      CC=2.00A
```

8. Press **[Shift]+[4]**(Save) keys for saving. Press **[11]** to save as the first step of the Program 2.

```
0.00V      0.00A
0.00W      Save : 11
```

It is assumed that step 2 edits CV mode as follows: voltage: 3V, maximum current value: 5A, and minimum current value: 0A

1. Press the **[CV]** key to set the voltage value as 3V. Press the **[Shift]+[CV]** (-Setup) keys to enter the parameter setting page.

```
Constant Voltage  
Range=1200.0V
```

2. Set the maximum working voltage value, and enter the **[Enter]** key.

```
Constant Voltage  
Range=1000.0V
```

3. Set the maximum current value, and enter the **[Enter]** key.

```
Constant Voltage  
High=5.00A
```

4. Set the minimum current value, and enter the **[Enter]** key.

```
Constant Voltage  
Low=0.00A
```

5. Set limited current value under CV mode and press **[Enter]** key.

```
Constant Voltage  
I-Limit=240.00A
```

6. Set high and low rate and press **[Enter]** key.

```
Constant Voltage  
High-Rate Low-Rate
```

After the parameter settings are complete, the page is shown as follows.

```
0.0V      0.00A  
0.0W      CV=3.0V
```

7. Press **[Shift]+[4]**(Save) keys for saving. Press **[12]** to save as the second step of the Program 2.

```
0.00V      0.00A  
0.00W      Save : 12
```

Note

Settings at each step should be independently saved. Saving positions of step parameters are related to save group and step number of auto test files. If the auto test file is saved in group 1, the saving position of step parameter is consistent with the step number; if the auto test file is saved in group 2, the saving position is 1+ step number, for example, steps 1, 2 and 3 are saved in 11, 12 and 13 respectively; if the auto test file is saved in group 3, the saving position is 2+ step number, for example, steps 1, 2 and 3 are saved in 21, 22 and 23 respectively, and so on. Refer to the following table for saving position

Correspondence Table of Auto test files and step parameter saving.

Program 1 Sequence	1	2	3	4	5	6	7	8	9	10
Save Group	1	2	3	4	5	6	7	8	9	10
Program 2 Sequence	1	2	3	4	5	6	7	8	9	10
Save Group	11	12	13	14	15	16	17	18	19	20
:	:	:	:	:	:	:	:	:	:	:
:	:	:	:	:	:	:	:	:	:	:
Program 10 Sequence	1	2	3	4	5	6	7	8	9	10
Save Group	91	92	93	94	95	96	97	98	99	100

Recall test file for running

To recall edited test files from EEPROM quickly after re-energizing instrument, refer to the method below.

1. Press **[Shift] + [6]**(Prog) keys.

```
PROGRAM
Run Recall Edit
```

2. Operate Left/Right key, select Recall and press **[Enter]** key.

```
RECALL PROGRAM
Recall Program File=2
```

3. Operate Left/Right key, select Run and press **[Enter]** key.

```
PROGRAM
Run Recall Edit
```

4. Display auto test file 2.

```
0.00V      0.00A
PRG02 STOP
```

5. Press **[Shift]+[.]** (Trigger) key. Operate auto test file 2.

```
0.00V      0.00A
PRG02-01 On Pass
```

6. Press **[Shift]+[0]**(Pause) key to pause auto test. Press Down key for next step.

3.21 Parallel Function

The maximum power of this series electronic loads is 60 KW. The user can connect electronic loads in parallel to provide a greater current and power capability. The electronic Load is capable of connecting up to nine units in parallel, reaching at most 384 KW.

3.21.1 Parallel Operation(multi-masters)

3 sets of 4U loads in parallel

The operation steps of parallel function are described below taking 3 instruments (1 Master and 2 Slave) in parallel as an example. The System Bus is used as connection between master and slaves; the Analog is used as analog signal connection for parallel.

CAUTION

- **Before connecting the system bus, the parallel mode must be single.**
-

1. Connect the instruments according to the following diagram.

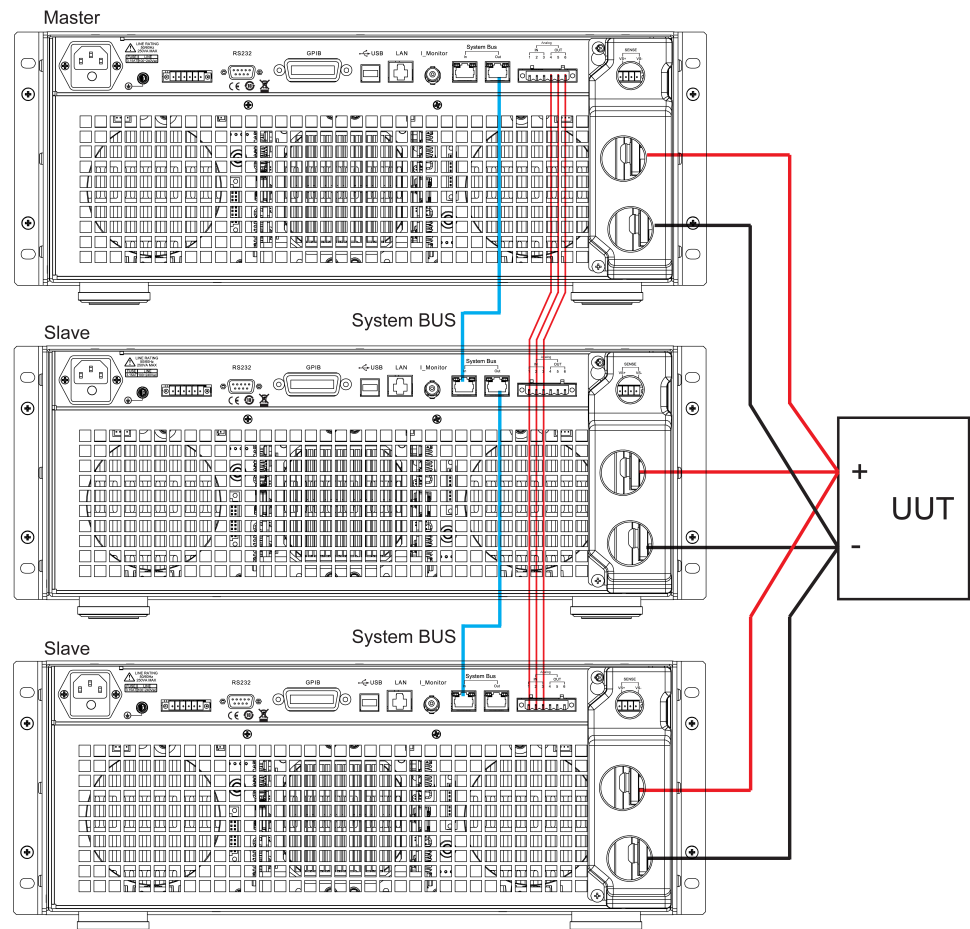

- a. Use standard network cables to connect System Bus terminals.
 - b. Use three-prong shield wires to connect Analog terminals.
 - c. Connect DUT. Refer to [1.5 Connecting the DUT](#) for detailed wiring method. To ensure the safety of the test, use a separate red and black test line to connect the input terminals of each instrument to the terminals of the object to be tested.
2. After connection, configure one electric load as a master unit and other electronic loads as slave units.
- a. Press the composite key **[Shift]+[8]**(System) to enter the System Menu.
 - b. Press the Right key to select "Parallel" and press **[Enter]** for parallel setting.
 - Single: Single mode.
 - Slave: Slave mode.
 - Master: Master mode. If Master mode is selected, you need to set the number of Slaves for the Master.
 - Total: total number of instruments in parallel. For example, Total = 3.
3. After making the master-slave setting, to ensure normal operation, you need to restart the electronic loads.

2 sets of 8U loads in parallel

The operation steps of parallel function are described below taking 2 instruments (1 Master and 1Slave) in parallel as an example. The System Bus is used as connection between master and slaves; the Analog is used as analog signal connection for parallel.

CAUTION

- **Before connecting the system bus, the parallel mode must be single.**
-

1. Connect the instruments according to the following diagram.

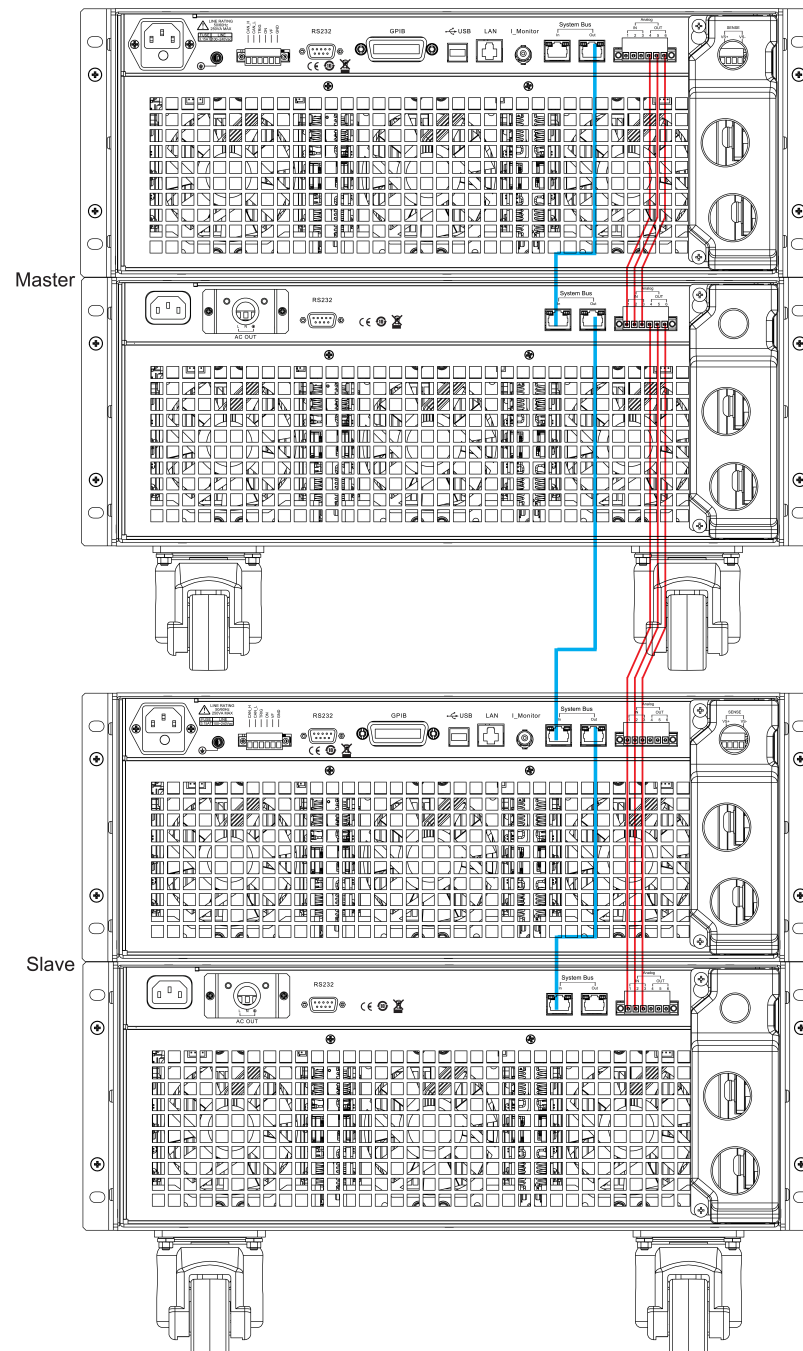

- a. Use standard network cables to connect System Bus terminals.
 - b. Use three-prong shield wires to connect Analog terminals.
 - c. Connect DUT. Refer to [1.5 Connecting the DUT](#) for detailed wiring method. To ensure the safety of the test, use a separate red and black test line to connect the input terminals of each instrument to the terminals of the object to be tested.
2. After connection, configure one 8U load as a master unit and another 8U load as slave units.
- a. Press the composite key **[Shift]+[8]**(System) to enter the System Menu.
 - b. Press the Right key to select "Parallel" and press **[Enter]** for parallel setting.

- Single: Single mode.
 - Slave: Slave mode.
 - Master: Master mode. If Master mode is selected, you need to set the number of Slaves for the Master.
 - Total: total number of instruments in parallel. For example, Total = 2.
3. After making the master-slave setting, to ensure normal operation, you need to restart the electronic loads.

Revert to single mode

To change Parallel Mode to Single Mode, follow the steps below:

1. Power off 3 instruments respectively.
2. Remove System Bus, Analog cables and parallel wires among three electronic loads.
3. Power on 3 instruments respectively.
4. Switch three instruments into single mode respectively.
 - a. Press the composite key **[Shift]+[8]**(System) to enter the System Menu.
 - b. Press the Left/Right key to select “Parallel” and press **[Enter]** key.
 - c. Press the Left/Right key to select “Single” and press **[Enter]** key.
5. After setting, to ensure normal operation, you need to Initialize the electronic loads.
 - a. Press the composite key **[Shift]+[8]**(System) to enter system menu setting screen.
 - b. Operate Left/Right key and move to the Initialize and press **[Enter]** key.
 - c. Select “YES” and Press **[Enter]** to restore to factory setting values.

3.21.2 Parallel Operation(one master and multi-slaves)

“One master and multiple slaves” means that there is only one instrument with operating panel (namely, the master) in the parallel system, and the other instruments have no operating panels (namely, the slaves). In the “one master and multiple slaves” system, you only need to operate the master’s front panel.

This section uses four instruments as an example to introduce the steps for parallel connection with one master and three slaves. The type and assembly method for parallel connection of other quantities of instruments are the same.

WARNING

- Before connecting the cables, ensure that the instrument power switch is off and the main switch of the AC power input (distribution box) is off.
- Before connecting 4 single instruments to the AC distribution box, ensure that the distribution box capacity is sufficient. Refer to the corresponding specifications for the AC input parameters of a single instrument.

1. Ensure that the power switches of the master unit and the main switch of the AC power distribution box are off.
2. Connect the instruments according to the following diagram.

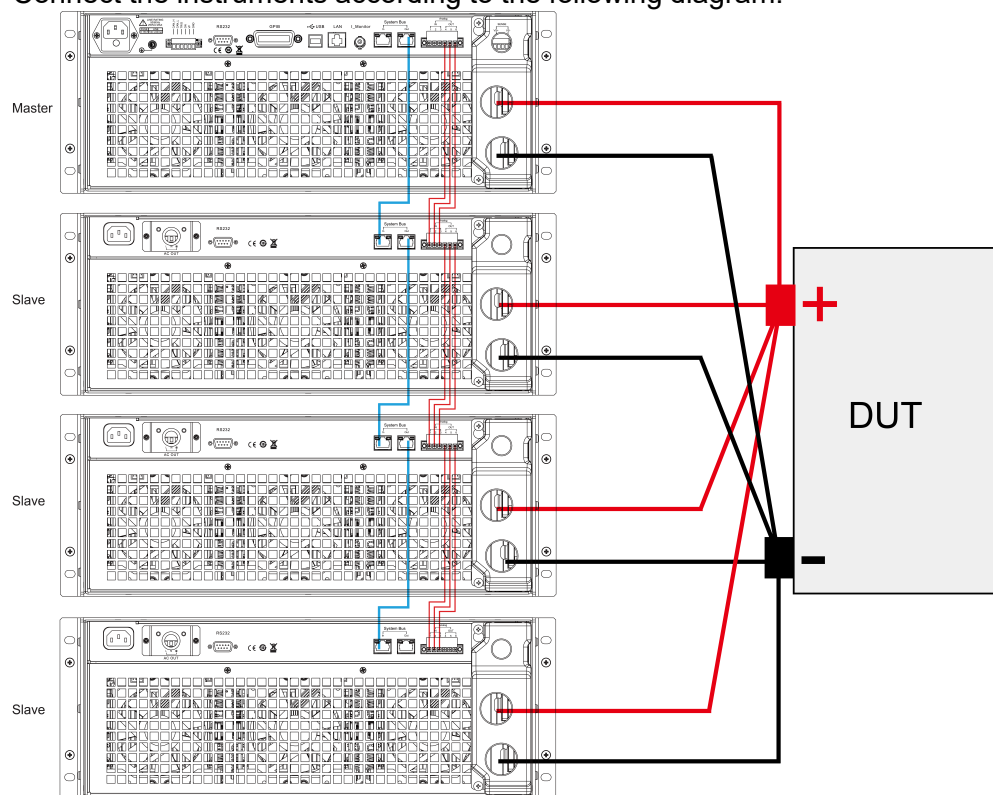

- a. To connect the parallel cable, link the System Bus Out terminal of the preceding IT8400 to the System Bus In terminal of the subsequent IT8400.
 - b. To connect the analog signal lines, correspondingly link the Analog 4, 5, 6 ports of the preceding IT8400 to the Analog 1, 2, 3 ports of the subsequent IT8400.
 - c. Connect DUT. Refer to [1.5 Connecting the DUT](#) for detailed wiring method. To ensure the safety of the test, use a separate red and black test line to connect the input terminals of each instrument to the terminals of the object to be tested.
3. Access 100V~240V power supply at the AC-IN position on the back panel of the instrument. Turn on the front panel power switch.
 4. Parallel setup.

- a. Press the **[Shift]** + **[←]** + **[→]** to enter the FACTORY MENU.
 - b. Enter 8400 and press **[Enter]**.
 - c. Press the Right key to select "ModNum" and press **[Enter]**.
 - d. Set Module Num to 4 and press **[Enter]**. Press **[Esc]** to return to the main screen.
5. After the setup is complete, you need to restart the electronic loads.

4 Technical Specification

This chapter will introduce the main technical parameters of this load, such as rated voltage/current/power and so on. Besides, we will introduce the working environment and storage temperature.

- ◆ Main specifications
- ◆ Additional features



Note

- To prevent damaging heat build-up and ensure specified performance, make sure there is adequate ventilation and air flow around the instrument to ensure proper cooling. Do not cover the ventilation holes on the top, sides, or bottom of the instrument.
- To ensure that the IT8400 series load meets the specified specifications and performance, please ensure that the inlet air temperature of the instrument is within the range of 0 to 25°C.

4.1 Main specifications

4.1.1 IT8406-600-150

Model		IT8406-600-150		
Rated value (0 ~ 40 °C)	Input voltage	0~600V		
	Input current	3A	15A	150A
	Input power	1.8KW	6KW	
	Min. operating voltage	0.45V@3A	0.525V@15A	5.25V@150A
Constant voltage mode	Range	0~60V	0~600V	
	Resolution	1mV	10mV	
	Accuracy	±(0.05%+0.05%FS)	±(0.05%+0.05%FS)	
Constant current mode	Range	0~3A	0~15A	0~150A
	Resolution	0.1mA	0.5mA	5mA
	Accuracy	±(0.05%+0.1%FS)	±(0.05%+0.05%FS)	±(0.05%+0.05%FS)
Constant resistance mode *1	Range	0.035Ω~10Ω	10Ω~7.5KΩ	
	Resolution	16bit		

Model		IT8406-600-150		
	Accuracy	0.01%+0.08S *2	0.01%+0.0008S	
Constant power Mode *3	Range	6KW		
	Resolution	0.1W		
	Accuracy	0.2%+0.2%FS		
Dynamic Mode				
Dynamic Mode *4	CC Mode			
	T1 & T2	20uS~3600S /Res:1 us/10ms/100ms		
	Accuracy	5uS±100ppm		
	Ascending/descending slope	0.0001~0.1A/uS	0.0005~0.75A/uS	0.005~10 A/uS
	Min. rise time *5	≈30uS	≈20uS	≈15uS
Measuring range				
Read-back voltage	Range	0~60V	0~600V	
	Resolution	1mV	10mV	
	Accuracy	±(0.025%+0.025%FS)	±(0.025%+0.025%FS)	
Read-back current	Range	0~3A	0~15A	0~150A
	Resolution	0.1mA	0.5mA	5mA
	Accuracy	±(0.05%+0.1%FS)	±(0.05%+0.05%FS)	±(0.05%+0.05%FS)
Read-back power *2	Range	6KW		
	Resolution	0.1W		
	Accuracy	±(0.2%+0.2%FS)		
Protection range				
Overpower protection	1.89KW	≈6.05KW		
Overcurrent protection	≈3.15A	≈15.75A	≈157.5A	
Overvoltage protection	≈630V			
Overtemperature protection	≈85°C			
Specification				
Short circuit	Current (CC)	≈3.15A	≈15.75A	≈157.5A

Model		IT8406-600-150	
	Voltage (CV)	≅0V	
	Resistance (CR)	≅150mΩ	≅35mΩ
Input terminal impedance	≅1MΩ		
Height	4U		
Weight	40 Kg		
AC Input	Voltage	100~240Vac	
	Frequency	50/60Hz	
	Power	250VA max	

*1. The voltage/current input is no less than 10%FS (FS indicates the full scope).

*2. The scope of read-back resistance is $(1/(1/R+(1/R)*0.01\%+0.08), 1/(1/R-(1/R)*0.01\%-0.08))$.

*3. The voltage/current input is no less than 10%FS.

*4. The load current value is no less than 4% of FS_CCH.

*5. The load current value is no less than 10% of FS_CCH.

4.1.2 IT8412-600-300

Model		IT8412-600-300		
Rated value (0 ~ 40 °C)	Input voltage	0~600V		
	Input current	6A	30A	300A
	Input power	3.6KW	12KW	
	Min. operating voltage	0.45V@6A	0.525V@30A	5.25V@300A
Constant voltage mode	Range	0.1~60V		0.1~600V
	Resolution	1mV		10mV
	Accuracy	±(0.05%+0.05%FS)		±(0.05%+0.05%FS)
Constant current mode	Range	0~6A	0~30A	0~300A
	Resolution	0.2mA	1mA	10mA

Model		IT8412-600-300		
	Accuracy	$\pm(0.05\%+0.1\%FS)$	$\pm(0.05\%+0.05\%FS)$	$\pm(0.05\%+0.05\%FS)$
Constant resistance mode *1	Range	0.0175 Ω ~10 Ω		10 Ω ~7.5K Ω
	Resolution	16bit		
	Accuracy	0.01%+0.08S *2		0.01%+0.0008S
Constant power Mode *3	Range	12KW		
	Resolution	0.2W		
	Accuracy	0.2%+0.2%FS		
Dynamic Mode				
Dynamic Mode *4	CC Mode			
	T1 & T2	20 μ S~3600S /Res:1 μ s/10ms/100ms		
	Accuracy	5 μ S \pm 100ppm		
	Ascending/descending slope	0.0002~0.15A/ μ S	0.001~1A/ μ S	0.01~15 A/ μ S
	Min. rise time *5	\approx 40 μ S	\approx 30 μ S	\approx 20 μ S
Measuring range				
Read-back voltage	Range	0~60V		0~600V
	Resolution	1mV		10mV
	Accuracy	$\pm(0.025\%+0.025\%FS)$		$\pm(0.025\%+0.025\%FS)$
Read-back current	Range	0~6A	0~30A	0~300A
	Resolution	0.2mA	1mA	10mA
	Accuracy	$\pm(0.05\%+0.1\%FS)$	$\pm(0.05\%+0.05\%FS)$	$\pm(0.05\%+0.05\%FS)$
Read-back power *2	Range	12KW		
	Resolution	0.2W		
	Accuracy	$\pm(0.2\%+0.2\%FS)$		
Protection range				
Overpower protection	3.78KW		\approx 12.1KW	
Overcurrent protection	\approx 6.3A		\approx 31.5A	\approx 315A
Overvoltage protection	\approx 630V			
Overtemperature protection	\approx 85 $^{\circ}$ C			

Model		IT8412-600-300		
Specification				
Short circuit	Current (CC)	≈6.3A	≈31.5A	≈315A
	Voltage (CV)	≈0V		
	Resistance (CR)	≈75mΩ	≈17.5mΩ	
Input terminal impedance	≈500KΩ			
Height	8U			
AC Input	Voltage	100~240Vac		
	Frequency	50/60Hz		
	Power	500VA max		

*1. The voltage/current input is no less than 10%FS (FS indicates the full scope).

*2. The scope of read-back resistance is $(1/(1/R+(1/R)*0.01\%+0.08), 1/(1/R-(1/R)*0.01\%-0.08))$.

*3. The voltage/current input is no less than 10%FS.

*4. The load current value is no less than 4% of FS_CCH.

*5. The load current value is no less than 10% of FS_CCH.

4.1.3 IT8418-600-450

Model		IT8418-600-450		
Rated value (0 ~ 40 °C)	Input voltage	0~600V		
	Input current	9A	45A	450A
	Input power	5.4KW	18KW	
	Min. operating voltage	0.45V@9A	0.525V@45A	5.25V@450A
Constant voltage mode	Range	0.1~60V	0.1~600V	
	Resolution	1mV	10mV	
	Accuracy	±(0.05%+0.05%FS)	±(0.05%+0.05%FS)	

Model		IT8418-600-450		
Constant current mode	Range	0~9A	0~45A	0~450A
	Resolution	0.3mA	1mA	10mA
	Accuracy	$\pm(0.05\%+0.1\%FS)$	$\pm(0.05\%+0.05\%FS)$	$\pm(0.05\%+0.05\%FS)$
Constant re- sistance mode *1	Range	0.012 Ω ~10 Ω	10 Ω ~7.5K Ω	
	Resolution	16bit		
	Accuracy	0.01%+0.08S *2	0.01%+0.0008S	
Constant power Mode *3	Range	18KW		
	Resolution	0.3W		
	Accuracy	0.2%+0.2%FS		
Dynamic Mode				
Dynamic Mode *4	CC Mode			
	T1 & T2	20 μ S~3600S /Res:1 μ s/10ms/100ms		
	Accuracy	5 μ S \pm 100ppm		
	Ascending/ descending slope	0.0002~0.225A/ μ S	0.001~1.5A/ μ S	0.01~22.5 A/ μ S
	Min. rise time *5	\approx 40 μ S	\approx 30 μ S	\approx 20 μ S
Measuring range				
Read-back voltage	Range	0~60V	0~600V	
	Resolution	1mV	10mV	
	Accuracy	$\pm(0.025\%+0.025\%FS)$	$\pm(0.025\%+0.025\%FS)$	
Read-back current	Range	0~9A	0~45A	0~450A
	Resolution	0.3mA	1mA	10mA
	Accuracy	$\pm(0.05\%+0.1\%FS)$	$\pm(0.05\%+0.05\%FS)$	$\pm(0.05\%+0.05\%FS)$
Read-back power *2	Range	18KW		
	Resolution	0.3W		
	Accuracy	$\pm(0.2\%+0.2\%FS)$		
Protection range				
Overpower protection	5.67KW		\approx 18.15KW	
Overcurrent protection	\approx 9.45A	\approx 47.25A	\approx 472.5A	
Overvoltage protection	\approx 630V			

Model		IT8418-600-450		
Overtemperature protection	≈85°C			
Specification				
Short circuit	Current (CC)	≈9.45A	≈47.25A	≈472.5A
	Voltage (CV)	≈0V		
	Resistance (CR)	≈50mΩ	≈12mΩ	
Input terminal impedance	≈333KΩ			
Height	15U			
AC Input	Voltage	100~240Vac		
	Frequency	50/60Hz		
	Power	750VA max		

*1. The voltage/current input is no less than 10%FS (FS indicates the full scope).

*2. The scope of read-back resistance is $(1/(1/R+(1/R)*0.01\%+0.08), 1/(1/R-(1/R)*0.01\%-0.08))$.

*3. The voltage/current input is no less than 10%FS.

*4. The load current value is no less than 4% of FS_CCH.

*5. The load current value is no less than 10% of FS_CCH.

4.1.4 IT8424-600-600

Model		IT8424-600-600		
Rated value (0 ~ 40 °C)	Input voltage	0~600V		
	Input current	12A	60A	600A
	Input power	7.2KW	24KW	
	Min. operating voltage	0.45V@12A	0.525V@60A	5.25V@600A
Constant voltage mode	Range	0.1~60V	0.1~600V	

Model		IT8424-600-600		
	Resolution	1mV		10mV
	Accuracy	$\pm(0.05\%+0.05\%FS)$		$\pm(0.05\%+0.05\%FS)$
Constant current mode	Range	0~12A	0~60A	0~600A
	Resolution	0.4mA	2mA	20mA
	Accuracy	$\pm(0.05\%+0.1\%FS)$	$\pm(0.05\%+0.05\%FS)$	$\pm(0.05\%+0.05\%FS)$
Constant re- sistance mode *1	Range	0.009 Ω ~10 Ω		10 Ω ~7.5K Ω
	Resolution	16bit		
	Accuracy	0.01%+0.08S *2		0.01%+0.0008S
Constant power Mode *3	Range	24KW		
	Resolution	0.4W		
	Accuracy	0.2%+0.2%FS		
Dynamic Mode				
Dynamic Mode *4	CC Mode			
	T1 & T2	20 μ S~3600S /Res:1 μ s/10ms/100ms		
	Accuracy	5 μ S \pm 100ppm		
	Ascending/ descending slope	0.0004~0.3A/ μ S	0.002~2A/ μ S	0.02~30 A/ μ S
	Min. rise time *5	\approx 40 μ S	\approx 30 μ S	\approx 20 μ S
Measuring range				
Read-back voltage	Range	0~60V		0~600V
	Resolution	1mV		10mV
	Accuracy	$\pm(0.025\%+0.025\%FS)$		$\pm(0.025\%+0.025\%FS)$
Read-back current	Range	0~12A	0~60A	0~600A
	Resolution	0.4mA	2mA	20mA
	Accuracy	$\pm(0.05\%+0.1\%FS)$	$\pm(0.05\%+0.05\%FS)$	$\pm(0.05\%+0.05\%FS)$
Read-back power *2	Range	18KW		
	Resolution	0.4W		
	Accuracy	$\pm(0.2\%+0.2\%FS)$		
Protection range				
Overpower protection	7.56KW		\approx 24.2KW	
Overcurrent protection	\approx 12.6A	\approx 63A	\approx 630A	

Model		IT8424-600-600		
Overvoltage protection	≈630V			
Overtemperature protection	≈85°C			
Specification				
Short circuit	Current (CC)	≈12.6A	≈63A	≈630A
	Voltage (CV)	≈0V		
	Resistance (CR)	≈37.5mΩ	≈9mΩ	
Input terminal impedance	≈250KΩ			
Height	27U			
AC Input	Voltage	100~240Vac		
	Frequency	50/60Hz		
	Power	1000VA max		

*1. The voltage/current input is no less than 10%FS (FS indicates the full scope).

*2. The scope of read-back resistance is $(1/(1/R+(1/R)*0.01\%+0.08), 1/(1/R-(1/R)*0.01\%-0.08))$.

*3. The voltage/current input is no less than 10%FS.

*4. The load current value is no less than 4% of FS_CCH.

*5. The load current value is no less than 10% of FS_CCH.

4.1.5 IT8430-600-750

Model		IT8430-600-750		
Rated value (0 ~ 40 °C)	Input voltage	0~600V		
	Input current	15A	75A	750A
	Input power	9KW	30KW	
	Min. operating voltage	0.45V@15A	0.525V@75A	5.25V@750A

Model		IT8430-600-750		
Constant voltage mode	Range	0~60V		0~600V
	Resolution	1mV		10mV
	Accuracy	$\pm(0.05\%+0.05\%FS)$		$\pm(0.05\%+0.05\%FS)$
Constant current mode	Range	0~15A	0~75A	0~750A
	Resolution	0.5mA	2.5mA	25mA
	Accuracy	$\pm(0.05\%+0.1\%FS)$	$\pm(0.05\%+0.05\%FS)$	$\pm(0.05\%+0.05\%FS)$
Constant re- sistance mode *1	Range	0.007 Ω ~10 Ω		10 Ω ~7.5K Ω
	Resolution	16bit		
	Accuracy	0.01%+0.08S *2		0.01%+0.0008S
Constant power Mode *3	Range	30KW		
	Resolution	0.5W		
	Accuracy	0.2%+0.2%FS		
Dynamic Mode				
Dynamic Mode *4	CC Mode			
	T1 & T2	20 μ S~3600S /Res:1 μ s/10ms/100ms		
	Accuracy	5 μ S \pm 100ppm		
	Ascending/ descending slope	0.0005~0.375A/ μ S	0.0025~2.5A/ μ S	0.025~37.5A/ μ S
	Min. rise time *5	\approx 40 μ S	\approx 30 μ S	\approx 20 μ S
Measuring range				
Read-back voltage	Range	0~60V		0~600V
	Resolution	1mV		10mV
	Accuracy	$\pm(0.025\%+0.025\%FS)$		$\pm(0.025\%+0.025\%FS)$
Read-back current	Range	0~15A	0~75A	0~750A
	Resolution	0.5mA	2.5mA	25mA
	Accuracy	$\pm(0.05\%+0.1\%FS)$	$\pm(0.05\%+0.05\%FS)$	$\pm(0.05\%+0.05\%FS)$
Read-back power *2	Range	30KW		
	Resolution	0.5W		
	Accuracy	$\pm(0.2\%+0.2\%FS)$		
Protection range				
Overpower protection	9.45KW		\approx 30.25KW	

Model		IT8430-600-750		
Overcurrent protection		≈15.75A	≈78.75A	≈787.5A
Overvoltage protection		≈630V		
Overtemperature protection		≈85°C		
Specification				
Short circuit	Current (CC)	≈15.75A	≈78.75A	≈787.5A
	Voltage (CV)	≈0V		
	Resistance (CR)	≈30mΩ	≈7mΩ	
Input terminal impedance		≈200KΩ		
Height		27U		
AC Input	Voltage	100~240Vac		
	Frequency	50/60Hz		
	Power	1250VA max		

*1. The voltage/current input is no less than 10%FS (FS indicates the full scope).

*2. The scope of read-back resistance is $(1/(1/R+(1/R)*0.01\%+0.08), 1/(1/R-(1/R)*0.01\%-0.08))$.

*3. The voltage/current input is no less than 10%FS.

*4. The load current value is no less than 4% of FS_CCH.

*5. The load current value is no less than 10% of FS_CCH.

4.1.6 IT8436-600-900

Model		IT8436-600-900		
Rated value (0 ~ 40 °C)	Input voltage	0~600V		
	Input current	18A	90A	900A
	Input power	10.8KW	36KW	

Model		IT8436-600-900		
	Min. operating voltage	0.45V@18A	0.525V@90A	5.25V@900A
Constant voltage mode	Range	0.1~60V		0.1~600V
	Resolution	1mV		10mV
	Accuracy	±(0.05%+0.05%FS)		±(0.05%+0.05%FS)
Constant current mode	Range	0~18A	0~90A	0~900A
	Resolution	0.6mA	3mA	30mA
	Accuracy	±(0.05%+0.1%FS)	±(0.05%+0.05%FS)	±(0.05%+0.05%FS)
Constant resistance mode *1	Range	0.006Ω~10Ω		10Ω~7.5KΩ
	Resolution	16bit		
	Accuracy	0.01%+0.08S *2		0.01%+0.0008S
Constant power Mode *3	Range	36KW		
	Resolution	0.6W		
	Accuracy	0.2%+0.2%FS		
Dynamic Mode				
Dynamic Mode *4	CC Mode			
	T1 & T2	20uS~3600S /Res:1 us/10ms/100ms		
	Accuracy	5uS±100ppm		
	Ascending/descending slope	0.0006~0.45A/uS	0.003~3A/uS	0.03~45A/uS
	Min. rise time *5	≈40uS	≈30uS	≈20uS
Measuring range				
Read-back voltage	Range	0~60V		0~600V
	Resolution	1mV		10mV
	Accuracy	±(0.025%+0.025%FS)		±(0.025%+0.025%FS)
Read-back current	Range	0~18A	0~90A	0~900A
	Resolution	0.6mA	3mA	30mA
	Accuracy	±(0.05%+0.1%FS)	±(0.05%+0.05%FS)	±(0.05%+0.05%FS)
Read-back power *2	Range	18KW		
	Resolution	0.6W		
	Accuracy	±(0.2%+0.2%FS)		
Protection range				

Model		IT8436-600-900		
Overpower protection	11.34KW	≈36.3KW		
Overcurrent protection	≈18.9A	≈94.5A	≈945A	
Overvoltage protection	≈630V			
Overtemperature protection	≈85°C			
Specification				
Short circuit	Current (CC)	≈18.9A	≈94.5A	≈945A
	Voltage (CV)	≈0V		
	Resistance (CR)	≈25mΩ	≈6mΩ	
Input terminal impedance	≈166.67KΩ			
Height	27U			
AC Input	Voltage	100~240Vac		
	Frequency	50/60Hz		
	Power	1500VA max		

*1. The voltage/current input is no less than 10%FS (FS indicates the full scope).

*2. The scope of read-back resistance is $(1/(1/R+(1/R)*0.01\%+0.08), 1/(1/R-(1/R)*0.01\%-0.08))$.

*3. The voltage/current input is no less than 10%FS.

*4. The load current value is no less than 4% of FS_CCH.

*5. The load current value is no less than 10% of FS_CCH.

4.1.7 IT8442-600-1050

Model		IT8442-600-1050		
Rated value (0 ~ 40 °C)	Input voltage	0~600V		
	Input current	21A	105A	1050A
	Input power	12.6KW	42KW	

Model		IT8442-600-1050		
	Min. operating voltage	0.45V@21A	0.525V@105A	5.25V@450A
Constant voltage mode	Range	0.1~60V		0.1~600V
	Resolution	1mV		10mV
	Accuracy	±(0.05%+0.05%FS)		±(0.05%+0.05%FS)
Constant current mode	Range	0~21A	0~105A	0~1050A
	Resolution	0.7mA	3.5mA	35mA
	Accuracy	±(0.05%+0.1%FS)	±(0.05%+0.05%FS)	±(0.05%+0.05%FS)
Constant resistance mode *1	Range	0.005Ω~10Ω		10Ω~7.5KΩ
	Resolution	16bit		
	Accuracy	0.01%+0.08S *2		0.01%+0.0008S
Constant power Mode *3	Range	18KW		
	Resolution	0.7W		
	Accuracy	0.2%+0.2%FS		
Dynamic Mode				
Dynamic Mode *4	CC Mode			
	T1 & T2	20uS~3600S /Res:1 us/10ms/100ms		
	Accuracy	5uS±100ppm		
	Ascending/descending slope	0.0007~0.525A/uS	0.0035~3A/uS	0.035~45 A/uS
	Min. rise time *5	≈40uS	≈30uS	≈20uS
Measuring range				
Read-back voltage	Range	0~60V		0~600V
	Resolution	1mV		10mV
	Accuracy	±(0.025%+0.025%FS)		±(0.025%+0.025%FS)
Read-back current	Range	0~21A	0~105A	0~1050A
	Resolution	0.7mA	3.5mA	35mA
	Accuracy	±(0.05%+0.1%FS)	±(0.05%+0.05%FS)	±(0.05%+0.05%FS)
Read-back power *2	Range	42KW		
	Resolution	0.7W		
	Accuracy	±(0.2%+0.2%FS)		
Protection range				

Model		IT8442-600-1050		
Overpower protection	13.23KW	≈42.35KW		
Overcurrent protection	≈22.05A	≈110.25A	≈1102.5A	
Overvoltage protection	≈630V			
Overtemperature protection	≈85°C			
Specification				
Short circuit	Current (CC)	≈22.05A	≈110.25A	≈1102.5A
	Voltage (CV)	≈0V		
	Resistance (CR)	≈22mΩ	≈5mΩ	
Input terminal impedance	≈142.8KΩ			
Height	37U			
AC Input	Voltage	100~240Vac		
	Frequency	50/60Hz		
	Power	1750VA max		

*1. The voltage/current input is no less than 10%FS (FS indicates the full scope).

*2. The scope of read-back resistance is $(1/(1/R+(1/R)*0.01\%+0.08), 1/(1/R-(1/R)*0.01\%-0.08))$.

*3. The voltage/current input is no less than 10%FS.

*4. The load current value is no less than 4% of FS_CCH.

*5. The load current value is no less than 10% of FS_CCH.

4.1.8 IT8448-600-1200

Model		IT8448-600-1200		
Rated value (0 ~ 40 °C)	Input voltage	0~600V		
	Input current	24A	120A	1200A
	Input power	14.4KW	48KW	

Model		IT8448-600-1200		
	Min. operating voltage	0.45V@24A	0.525V@120A	5.25V@1200A
Constant voltage mode	Range	0.1~60V		0.1~600V
	Resolution	1mV		10mV
	Accuracy	±(0.05%+0.05%FS)		±(0.05%+0.05%FS)
Constant current mode	Range	0~24A	0~120A	0~1200A
	Resolution	0.8mA	4mA	40mA
	Accuracy	±(0.05%+0.1%FS)	±(0.05%+0.05%FS)	±(0.05%+0.05%FS)
Constant resistance mode *1	Range	0.0Ω~10Ω		10Ω~7.5KΩ
	Resolution	16bit		
	Accuracy	0.01%+0.08S *2		0.01%+0.0008S
Constant power Mode *3	Range	18KW		
	Resolution	0.8W		
	Accuracy	0.2%+0.2%FS		
Dynamic Mode				
Dynamic Mode *4	CC Mode			
	T1 & T2	20uS~3600S /Res:1 us/10ms/100ms		
	Accuracy	5uS±100ppm		
	Ascending/descending slope	0.0008~0.6A/uS	0.004~3A/uS	0.04~45A/uS
	Min. rise time *5	≈40uS	≈30uS	≈20uS
Measuring range				
Read-back voltage	Range	0~60V		0~600V
	Resolution	1mV		10mV
	Accuracy	±(0.025%+0.025%FS)		±(0.025%+0.025%FS)
Read-back current	Range	0~24A	0~120A	0~1200A
	Resolution	0.8mA	4mA	40mA
	Accuracy	±(0.05%+0.1%FS)	±(0.05%+0.05%FS)	±(0.05%+0.05%FS)
Read-back power *2	Range	48KW		
	Resolution	0.8W		
	Accuracy	±(0.2%+0.2%FS)		
Protection range				

Model		IT8448-600-1200		
Overpower protection	15.12KW	≈48.4KW		
Overcurrent protection	≈25.2A	≈126A	≈1260A	
Overvoltage protection	≈630V			
Overtemperature protection	≈85°C			
Specification				
Short circuit	Current (CC)	≈25.2A	≈126A	≈1260A
	Voltage (CV)	≈0V		
	Resistance (CR)	≈18.75mΩ	≈5mΩ	
Input terminal impedance	≈125KΩ			
Height	37U			
AC Input	Voltage	100~240Vac		
	Frequency	50/60Hz		
	Power	2000VA max		

*1. The voltage/current input is no less than 10%FS (FS indicates the full scope).

*2. The scope of read-back resistance is $(1/(1/R+(1/R)*0.01\%+0.08), 1/(1/R-(1/R)*0.01\%-0.08))$.

*3. The voltage/current input is no less than 10%FS.

*4. The load current value is no less than 4% of FS_CCH.

*5. The load current value is no less than 10% of FS_CCH.

4.1.9 IT8454-600-1350

Model		IT8454-600-1350		
Rated value (0 ~ 40 °C)	Input voltage	0~600V		
	Input current	27A	135A	1350A

Model		IT8454-600-1350		
	Input power	16.2KW	54KW	
	Min. operating voltage	0.45V@27A	0.525V@135A	5.25V@1350A
Constant voltage mode	Range	0.1~60V	0.1~600V	
	Resolution	1mV	10mV	
	Accuracy	±(0.05%+0.05%FS)	±(0.05%+0.05%FS)	
Constant current mode	Range	0~27A	0~135A	0~1350A
	Resolution	0.9mA	4.5mA	45mA
	Accuracy	±(0.05%+0.1%FS)	±(0.05%+0.05%FS)	±(0.05%+0.05%FS)
Constant resistance mode *1	Range	0.004Ω~10Ω	10Ω~7.5KΩ	
	Resolution	16bit		
	Accuracy	0.01%+0.08S *2	0.01%+0.0008S	
Constant power Mode *3	Range	18KW		
	Resolution	0.9W		
	Accuracy	0.2%+0.2%FS		
Dynamic Mode				
Dynamic Mode *4	CC Mode			
	T1 & T2	20uS~3600S /Res:1 us/10ms/100ms		
	Accuracy	5uS±100ppm		
	Ascending/descending slope	0.0009~0.675A/uS	0.0045~3A/uS	0.045~45A/uS
	Min. rise time *5	≅40uS	≅30uS	≅20uS
Measuring range				
Read-back voltage	Range	0~60V	0~600V	
	Resolution	1mV	10mV	
	Accuracy	±(0.025%+0.025%FS)	±(0.025%+0.025%FS)	
Read-back current	Range	0~27A	0~135A	0~1350A
	Resolution	0.9mA	4.5mA	45mA
	Accuracy	±(0.05%+0.1%FS)	±(0.05%+0.05%FS)	±(0.05%+0.05%FS)
Read-back power *2	Range	18KW		
	Resolution	0.9W		

Model		IT8454-600-1350		
	Accuracy	$\pm(0.2\%+0.2\%FS)$		
Protection range				
Overpower protection	17.01KW	$\approx 54.45KW$		
Overcurrent protection	$\approx 28.23A$	$\approx 47.25A$	$\approx 472.5A$	
Overvoltage protection	$\approx 630V$			
Overtemperature protection	$\approx 85^{\circ}C$			
Specification				
Short circuit	Current (CC)	$\approx 9.45A$	$\approx 141.75A$	$\approx 1417.5A$
	Voltage (CV)	$\approx 0V$		
	Resistance (CR)	$\approx 16.66m\Omega$	$\approx 4m\Omega$	
Input terminal impedance	$\approx 111.11K\Omega$			
Height	37U			
AC Input	Voltage	100~240Vac		
	Frequency	50/60Hz		
	Power	2250VA max		

*1. The voltage/current input is no less than 10%FS (FS indicates the full scope).

*2. The scope of read-back resistance is $(1/(1/R+(1/R)*0.01\%+0.08), 1/(1/R-(1/R)*0.01\%-0.08))$.

*3. The voltage/current input is no less than 10%FS.

*4. The load current value is no less than 4% of FS_CCH.

*5. The load current value is no less than 10% of FS_CCH.

4.1.10 IT8406-1200-75

Model		IT8406-1200-75		
Rated value (0 ~ 40 °C)	Input voltage	0~1200V		
	Input current	1.5A	7.5A	75A
	Input power	1.8KW	6KW	
	Min. operating voltage	1.31V@1.5A	1.5V@7.5A	15V@75A
Constant voltage mode	Range	0.1~120V	0.1~1200V	
	Resolution	10mV	100mV	
	Accuracy	±(0.05%+0.05%FS)	±(0.05%+0.05%FS)	
Constant current mode	Range	1.5A	7.5A	75A
	Resolution	40uA	0.2mA	2mA
	Accuracy	0.05%+0.1%FS	0.05%+0.05%FS	0.05%+0.05%FS
Constant resistance mode	Range	0.2Ω~10Ω	10Ω~7.5KΩ	
*1	Resolution	16bit		
	Accuracy	0.01%+0.08S *2	0.01%+0.0008S	
Constant power Mode *3	Range	6KW		
	Resolution	0.1W		
	Accuracy	0.2%+0.2%FS		
Dynamic Mode				
Dynamic Mode *4	CC Mode			
	T1 & T2	20uS~3600S /Res:1 us/10ms/100ms		
	Accuracy	5uS±100ppm		
	Ascending/descending slope	0.00004~0.05A/uS	0.0002~0.3A/uS	0.002~5A/uS
	Min. rise time *5	≅30uS	≅25uS	≅15uS
Measuring range				
Read-back voltage	Range	0~120V	0~1200V	
	Resolution	10mV	100mV	
	Accuracy	±(0.025%+0.025%FS)	±(0.025%+0.025%FS)	
Read-back current	Range	1.5A	7.5A	75A

Model		IT8406-1200-75		
	Resolution	40uA	0.2mA	2mA
	Accuracy	0.05%+0.1%FS	0.05%+0.05%FS	0.05%+0.05%FS
Read-back power *2	Range	6KW		
	Resolution	0.1W		
	Accuracy	±(0.2%+0.2%FS)		
Protection range				
Overpower protection		≈1.89KW	≈6.05KW	≈6.05KW
Overcurrent protection		≈1.575A	≈7.875A	≈78.75A
Overvoltage protection		≈1250V		
Overtemperature protection		≈85°C		
Specification				
Short circuit	Current (CC)	≈1.575A	≈7.875A	≈78.75A
	Voltage (CV)	≈0V		≈0V
	Resistance (CR)	≈875mΩ	≈200mΩ	
Input terminal impedance		≈1.6MΩ		
Height		4U		
Weight		40 Kg		
AC Input	Voltage	100~240Vac		
	Frequency	50/60Hz		
	Power	250VA max		

*1. The voltage/current input is no less than 10%FS (FS indicates the full scope).

*2. The scope of read-back resistance is $(1/(1/R+(1/R)*0.01\%+0.08), 1/(1/R-(1/R)*0.01\%-0.08))$.

*3. The voltage/current input is no less than 10%FS.

*4. The load current value is no less than 4% of FS_CCH.

*5.The load current value is no less than 10% of FS_CCH.

4.1.11 IT8412-1200-150

Model		IT8412-1200-150		
Rated value (0 ~ 40 °C)	Input voltage	0~1200V		
	Input current	3A	15A	150A
	Input power	3.6KW	12KW	
	Min. operating voltage	1.31V@3A	1.5V@15A	15V@150A
Constant voltage mode	Range	0.1~120V	0.1~1200V	
	Resolution	10mV	100mV	
	Accuracy	±(0.05%+0.05%FS)	±(0.05%+0.05%FS)	
Constant current mode	Range	3A	15A	150A
	Resolution	80uA	0.4mA	4mA
	Accuracy	0.05%+0.1%FS	0.05%+0.05%FS	0.05%+0.05%FS
Constant resistance mode *1	Range	0.1Ω~10Ω	10Ω~7.5KΩ	
	Resolution	16bit		
	Accuracy	0.01%+0.08S *2	0.01%+0.0008S	
Constant power Mode *3	Range	12KW		
	Resolution	0.2W		
	Accuracy	0.2%+0.2%FS		
Dynamic Mode				
Dynamic Mode *4	CC Mode			
	T1 & T2	20uS~3600S /Res:1 us/10ms/100ms		
	Accuracy	5uS±100ppm		
	Ascending/descending slope	0.00008~0.075A/uS	0.0004~0.4A/uS	0.004~7.5A/uS
	Min. rise time *5	≅40uS	≅35uS	≅20uS
Measuring range				
Read-back voltage	Range	0~120V	0~1200V	
	Resolution	10mV	100mV	
	Accuracy	±(0.025%+0.025%FS)	±(0.025%+0.025%FS)	

Model		IT8412-1200-150		
Read-back current	Range	3A	15A	150A
	Resolution	80uA	0.4mA	4mA
	Accuracy	0.05%+0.1%FS	0.05%+0.05%FS	0.05%+0.05%FS
Read-back power *2	Range	12KW		
	Resolution	0.2W		
	Accuracy	±(0.2%+0.2%FS)		
Protection range				
Overpower protection	≈3.78KW		≈12.1KW	
Overcurrent protection	≈3.15A	≈15.75A	≈157.5A	
Overvoltage protection	≈1250V			
Overtemperature protection	≈85°C			
Specification				
Short circuit	Current (CC)	≈3.15A	≈15.75A	≈157.5A
	Voltage (CV)	≈0V		≈0V
	Resistance (CR)	≈437.5mΩ	≈100mΩ	
Input terminal impedance	≈800KΩ			
Height	8U			
Weight	80 Kg			
AC Input	Voltage	100~240Vac		
	Frequency	50/60Hz		
	Power	500VA max		

*1. The voltage/current input is no less than 10%FS (FS indicates the full scope).

*2. The scope of read-back resistance is $(1/(1/R+(1/R)*0.01\%+0.08), 1/(1/R-(1/R)*0.01\%-0.08))$.

*3. The voltage/current input is no less than 10%FS.

*4.The load current value is no less than 4% of FS_CCH.

*5.The load current value is no less than 10% of FS_CCH.

4.1.12 IT8418-1200-225

Model		IT8418-1200-225		
Rated value (0 ~ 40 °C)	Input voltage	0~1200V		
	Input current	4.5A	22.5A	225A
	Input power	5.4KW	18KW	
	Min. operating voltage	1.31V@4.5A	1.5V@22.5A	15V@225A
Constant voltage mode	Range	0~120V	0~1200V	
	Resolution	10mV	100mV	
	Accuracy	$\pm(0.05\%+0.05\%FS)$		$\pm(0.05\%+0.05\%FS)$
Constant current mode	Range	4.5A	22.5A	225A
	Resolution	0.00012A	0.6mA	6mA
	Accuracy	0.05%+0.1%FS	0.05%+0.05%FS	0.05%+0.05%FS
Constant resistance mode *1	Range	0.067Ω~10Ω	10Ω~7.5KΩ	
	Resolution	16bit		
	Accuracy	0.01%+0.08S *2	0.01%+0.0008S	
Constant power Mode *3	Range	18KW		
	Resolution	0.3W		
	Accuracy	0.2%+0.2%FS		
Dynamic Mode				
Dynamic Mode *4	CC Mode			
	T1 & T2	20uS~3600S /Res:1 us/10ms/100ms		
	Accuracy	5uS±100ppm		
	Ascending/descending slope	0.00012~0.1125A/uS	0.0006~0.6A/uS	0.006~11.25A/uS
	Min. rise time *5	≈40uS	≈35uS	≈20uS
Measuring range				
Read-back voltage	Range	0~120V	0~1200V	
	Resolution	10mV	100mV	

Model		IT8418-1200-225		
	Accuracy	$\pm(0.025\%+0.025\%FS)$		$\pm(0.025\%+0.025\%FS)$
Read-back current	Range	4.5A	22.5A	225A
	Resolution	0.00012A	0.6mA	6mA
	Accuracy	0.05%+0.1%FS	0.05%+0.05%FS	0.05%+0.05%FS
Read-back power *2	Range	18KW		
	Resolution	0.3W		
	Accuracy	$\pm(0.2\%+0.2\%FS)$		
Protection range				
Overpower protection	$\approx 5.67KW$	$\approx 18.15KW$		
Overcurrent protection	$\approx 4.725A$	$\approx 23.625A$	$\approx 236.25A$	
Overvoltage protection	$\approx 1250V$			
Overtemperature protection	$\approx 85^{\circ}C$			
Specification				
Short circuit	Current (CC)	$\approx 4.725A$	$\approx 23.625A$	$\approx 236.25A$
	Voltage (CV)	$\approx 0V$		$\approx 0V$
	Resistance (CR)	$\approx 291.66m\Omega$	$\approx 66.66m\Omega$	
Input terminal impedance	$\approx 533K\Omega$			
Height	15U			
AC Input	Voltage	100~240Vac		
	Frequency	50/60Hz		
	Power	750VA max		

*1. The voltage/current input is no less than 10%FS (FS indicates the full scope).

*2. The scope of read-back resistance is $(1/(1/R+(1/R)*0.01\%+0.08), 1/(1/R-(1/R)*0.01\%-0.08))$.

*3. The voltage/current input is no less than 10%FS.

*4.The load current value is no less than 4% of FS_CCH.

*5.The load current value is no less than 10% of FS_CCH.

4.1.13 IT8424-1200-300

Model		IT8424-1200-300		
Rated value (0 ~ 40 °C)	Input voltage	0~1200V		
	Input current	6A	30A	300A
	Input power	7.2KW	24KW	
	Min. operating voltage	1.31V@6A	1.5V@30A	15V@300A
Constant voltage mode	Range	0~120V	0~1200V	
	Resolution	10mV	100mV	
	Accuracy	±(0.05%+0.05%FS)		±(0.05%+0.05%FS)
Constant current mode	Range	6A	30A	300A
	Resolution	160uA	0.8mA	8mA
	Accuracy	0.05%+0.1%FS	0.05%+0.05%FS	0.05%+0.05%FS
Constant resistance mode *1	Range	0.05Ω~10Ω	10Ω~7.5KΩ	
	Resolution	16bit		
	Accuracy	0.01%+0.08S *2	0.01%+0.0008S	
Constant power Mode *3	Range	24KW		
	Resolution	0.4W		
	Accuracy	0.2%+0.2%FS		
Dynamic Mode				
Dynamic Mode *4	CC Mode			
	T1 & T2	20uS~3600S /Res:1 us/10ms/100ms		
	Accuracy	5uS±100ppm		
	Ascending/descending slope	0.00016~0.15A/uS	0.0008~0.85A/uS	0.008~15A/uS
	Min. rise time *5	≈40uS	≈35uS	≈20uS
Measuring range				
Read-back voltage	Range	0~120V	0~1200V	
	Resolution	10mV	100mV	

Model		IT8424-1200-300		
	Accuracy	$\pm(0.025\%+0.025\%FS)$		$\pm(0.025\%+0.025\%FS)$
Read-back current	Range	6A	30A	300A
	Resolution	160uA	0.8mA	8mA
	Accuracy	0.05%+0.1%FS	0.05%+0.05%FS	0.05%+0.05%FS
Read-back power *2	Range	24KW		
	Resolution	0.4W		
	Accuracy	$\pm(0.2\%+0.2\%FS)$		
Protection range				
Overpower protection	$\approx 7.56KW$	$\approx 24.2KW$		
Overcurrent protection	$\approx 6.3A$	$\approx 31.5A$	$\approx 315A$	
Overvoltage protection	$\approx 1250V$			
Overtemperature protection	$\approx 85^{\circ}C$			
Specification				
Short circuit	Current (CC)	$\approx 6.3A$	$\approx 31.5A$	$\approx 315A$
	Voltage (CV)	$\approx 0V$		$\approx 0V$
	Resistance (CR)	$\approx 218m\Omega$	$\approx 50m\Omega$	
Input terminal impedance	$\approx 400K\Omega$			
Height	27U			
AC Input	Voltage	100~240Vac		
	Frequency	50/60Hz		
	Power	1000VA max		

*1. The voltage/current input is no less than 10%FS (FS indicates the full scope).

*2. The scope of read-back resistance is $(1/(1/R+(1/R)*0.01\%+0.08), 1/(1/R-(1/R)*0.01\%-0.08))$.

*3. The voltage/current input is no less than 10%FS.

*4.The load current value is no less than 4% of FS_CCH.

*5.The load current value is no less than 10% of FS_CCH.

4.1.14 IT8430-1200-375

Model		IT8430-1200-375		
Rated value (0 ~ 40 °C)	Input voltage	0~1200V		
	Input current	7.5A	37.5A	375A
	Input power	9KW	30KW	
	Min. operating voltage	1.31V@7.5A	1.5V@37.5A	15V@375A
Constant voltage mode	Range	0~120V	0~1200V	
	Resolution	10mV	100mV	
	Accuracy	±(0.05%+0.05%FS)		±(0.05%+0.05%FS)
Constant current mode	Range	7.5A	37.5A	375A
	Resolution	200uA	1mA	10mA
	Accuracy	0.05%+0.1%FS	0.05%+0.05%FS	0.05%+0.05%FS
Constant resistance mode *1	Range	0.04Ω~10Ω	10Ω~7.5KΩ	
	Resolution	16bit		
	Accuracy	0.01%+0.08S *2	0.01%+0.0008S	
Constant power Mode *3	Range	30KW		
	Resolution	0.5W		
	Accuracy	0.2%+0.2%FS		
Dynamic Mode				
Dynamic Mode *4	CC Mode			
	T1 & T2	20uS~3600S /Res:1 us/10ms/100ms		
	Accuracy	5uS±100ppm		
	Ascending/descending slope	0.0002~0.18A/uS	0.001~1A/uS	0.01~18.75A/uS
	Min. rise time *5	≈40uS	≈35uS	≈20uS
Measuring range				
Read-back voltage	Range	0~120V	0~1200V	
	Resolution	10mV	100mV	
	Accuracy	±(0.025%+0.025%FS)		±(0.025%+0.025%FS)

Model		IT8430-1200-375		
Read-back current	Range	7.5A	37.5A	375A
	Resolution	200uA	1mA	10mA
	Accuracy	0.05%+0.1%FS	0.05%+0.05%FS	0.05%+0.05%FS
Read-back power *2	Range	30KW		
	Resolution	0.5W		
	Accuracy	±(0.2%+0.2%FS)		
Protection range				
Overpower protection	≈9.45KW		≈30.25KW	
Overcurrent protection	≈7.875A		≈39.375A	≈393.75A
Overvoltage protection	≈1250V			
Overtemperature protection	≈85°C			
Specification				
Short circuit	Current (CC)	≈7.875A	≈39.375A	≈393.75A
	Voltage (CV)	≈0V		≈0V
	Resistance (CR)	≈175mΩ	≈40mΩ	
Input terminal impedance	≈320KΩ			
Height	27U			
AC Input	Voltage	100~240Vac		
	Frequency	50/60Hz		
	Power	250VA max		

*1. The voltage/current input is no less than 10%FS (FS indicates the full scope).

*2. The scope of read-back resistance is $(1/(1/R+(1/R)*0.01\%+0.08), 1/(1/R-(1/R)*0.01\%-0.08))$.

*3. The voltage/current input is no less than 10%FS.

*4. The load current value is no less than 4% of FS_CCH.

*5. The load current value is no less than 10% of FS_CCH.

4.1.15 IT8436-1200-450

Model		IT8436-1200-450		
Rated value (0 ~ 40 °C)	Input voltage	0~1200V		
	Input current	9A	45A	450A
	Input power	10.8KW	36KW	
	Min. operating voltage	1.31V@9A	1.5V@45A	15V@450A
Constant voltage mode	Range	0.1~120V	0.1~1200V	
	Resolution	10mV	100mV	
	Accuracy	$\pm(0.05\%+0.05\%FS)$		$\pm(0.05\%+0.05\%FS)$
Constant current mode	Range	9A	45A	450A
	Resolution	240uA	1.2mA	12mA
	Accuracy	0.05%+0.1%FS	0.05%+0.05%FS	0.05%+0.05%FS
Constant resistance mode *1	Range	0.035Ω~10Ω	10Ω~7.5KΩ	
	Resolution	16bit		
	Accuracy	0.01%+0.08S *2	0.01%+0.0008S	
Constant power Mode *3	Range	36KW		
	Resolution	0.6W		
	Accuracy	0.2%+0.2%FS		
Dynamic Mode				
Dynamic Mode *4	CC Mode			
	T1 & T2	20uS~3600S /Res:1 us/10ms/100ms		
	Accuracy	5uS±100ppm		
	Ascending/descending slope	0.00024~0.225A/uS	0.0012~1.2A/uS	0.012~22.5A/uS
	Min. rise time	≈40uS	≈35uS	≈20uS
	*5			
Measuring range				
Read-back voltage	Range	0~120V	0~1200V	
	Resolution	10mV	100mV	
	Accuracy	$\pm(0.025\%+0.025\%FS)$		$\pm(0.025\%+0.025\%FS)$
Read-back current	Range	9A	45A	450A

Model		IT8436-1200-450		
	Resolution	240uA	1.2mA	12mA
	Accuracy	0.05%+0.1%FS	0.05%+0.05%FS	0.05%+0.05%FS
Read-back power *2	Range	36KW		
	Resolution	0.6W		
	Accuracy	±(0.2%+0.2%FS)		
Protection range				
Overpower protection	≈11.34KW	≈36.3KW		
Overcurrent protection	≈9.45A	≈47.25A	≈472.5A	
Overvoltage protection	≈1250V			
Overtemperature protection	≈85°C			
Specification				
Short circuit	Current (CC)	≈9.45A	≈47.25A	≈472.5A
	Voltage (CV)	≈0V		≈0V
	Resistance (CR)	≈145mΩ	≈33.33mΩ	
Input terminal impedance	≈266.66KΩ			
Height	27U			
AC Input	Voltage	100~240Vac		
	Frequency	50/60Hz		
	Power	1500VA max		

*1. The voltage/current input is no less than 10%FS (FS indicates the full scope).

*2. The scope of read-back resistance is $(1/(1/R+(1/R)*0.01\%+0.08), 1/(1/R-(1/R)*0.01\%-0.08))$.

*3. The voltage/current input is no less than 10%FS.

*4. The load current value is no less than 4% of FS_CCH.

*5.The load current value is no less than 10% of FS_CCH.

4.1.16 IT8442-1200-525

Model		IT8442-1200-525		
Rated value (0 ~ 40 °C)	Input voltage	0~1200V		
	Input current	10.5A	52.5A	525A
	Input power	12.6KW	42KW	
	Min. operating voltage	1.31V@10.5A	1.5V@52.5A	15V@525A
Constant voltage mode	Range	0.1~120V	0.1~1200V	
	Resolution	10mV	100mV	
	Accuracy	$\pm(0.05\%+0.05\%FS)$		
Constant current mode	Range	10.5A	52.5A	525A
	Resolution	280uA	1.4mA	14mA
	Accuracy	0.05%+0.1%FS	0.05%+0.05%FS	0.05%+0.05%FS
Constant resistance mode *1	Range	0.03Ω~10Ω	10Ω~7.5KΩ	
	Resolution	16bit		
	Accuracy	0.01%+0.08S *2	0.01%+0.0008S	
Constant power Mode *3	Range	42KW		
	Resolution	0.7W		
	Accuracy	0.2%+0.2%FS		
Dynamic Mode				
Dynamic Mode *4	CC Mode			
	T1 & T2	20uS~3600S /Res:1 us/10ms/100ms		
	Accuracy	5uS±100ppm		
	Ascending/descending slope	0.00028~0.26A/uS	0.0014~1.5A/uS	0.014~26.25A/uS
	Min. rise time *5	≈40uS	≈35uS	≈20uS
Measuring range				
Read-back voltage	Range	0~120V	0~1200V	
	Resolution	10mV	100mV	
	Accuracy	$\pm(0.025\%+0.025\%FS)$		

Model		IT8442-1200-525		
Read-back current	Range	10.5A	52.5A	525A
	Resolution	280uA	1.4mA	14mA
	Accuracy	0.05%+0.1%FS	0.05%+0.05%FS	0.05%+0.05%FS
Read-back power *2	Range	47KW		
	Resolution	0.7W		
	Accuracy	±(0.2%+0.2%FS)		
Protection range				
Overpower protection	≈13.23KW		≈42.35KW	
Overcurrent protection	≈11.025A		≈55.125A	≈551.25A
Overvoltage protection	≈1250V			
Overtemperature protection	≈85°C			
Specification				
Short circuit	Current (CC)	≈11.025A	≈55.125A	≈551.25A
	Voltage (CV)	≈0V		≈0V
	Resistance (CR)	≈125mΩ	≈28.6mΩ	
Input terminal impedance	≈228KΩ			
Height	37U			
AC Input	Voltage	100~240Vac		
	Frequency	50/60Hz		
	Power	1750VA max		

*1. The voltage/current input is no less than 10%FS (FS indicates the full scope).

*2. The scope of read-back resistance is $(1/(1/R+(1/R)*0.01\%+0.08), 1/(1/R-(1/R)*0.01\%-0.08))$.

*3. The voltage/current input is no less than 10%FS.

*4. The load current value is no less than 4% of FS_CCH.

*5.The load current value is no less than 10% of FS_CCH.

4.1.17 IT8454-1200-675

Model		IT8454-1200-675		
Rated value (0 ~ 40 °C)	Input voltage	0~1200V		
	Input current	13.5A	67.5A	675A
	Input power	16.2KW	54KW	
	Min. operating voltage	1.31V@13.5A	1.5V@67.5A	15V@675A
Constant voltage mode	Range	0~120V	0~1200V	
	Resolution	10mV	100mV	
	Accuracy	±(0.05%+0.05%FS)	±(0.05%+0.05%FS)	
Constant current mode	Range	13.5A	67.5A	675A
	Resolution	360uA	1.8mA	18mA
	Accuracy	0.05%+0.1%FS	0.05%+0.05%FS	0.05%+0.05%FS
Constant resistance mode *1	Range	0.025Ω~10Ω	10Ω~7.5KΩ	
	Resolution	16bit		
	Accuracy	0.01%+0.08S *2	0.01%+0.0008S	
Constant power Mode *3	Range	54KW		
	Resolution	0.9W		
	Accuracy	0.2%+0.2%FS		
Dynamic Mode				
Dynamic Mode *4	CC Mode			
	T1 & T2	20uS~3600S /Res:1 us/10ms/100ms		
	Accuracy	5uS±100ppm		
	Ascending/descending slope	0.00036~0.33A/uS	0.0018~1.9A/uS	0.018~33.75A/uS
	Min. rise time *5	≈40uS	≈35uS	≈20uS
Measuring range				
Read-back voltage	Range	0~120V	0~1200V	
	Resolution	10mV	100mV	
	Accuracy	±(0.025%+0.025%FS)	±(0.025%+0.025%FS)	

Model		IT8454-1200-675		
Read-back current	Range	13.5A	67.5A	675A
	Resolution	360uA	1.8mA	18mA
	Accuracy	0.05%+0.1%FS	0.05%+0.05%FS	0.05%+0.05%FS
Read-back power *2	Range	54KW		
	Resolution	0.9W		
	Accuracy	±(0.2%+0.2%FS)		
Protection range				
Overpower protection	≈17.01KW		≈54.45KW	
Overcurrent protection	≈14.175A	≈70.875A	≈708.75A	
Overvoltage protection	≈1250V			
Overtemperature protection	≈85°C			
Specification				
Short circuit	Current (CC)	≈14.175A	≈70.875A	≈708.75A
	Voltage (CV)	≈0V		≈0V
	Resistance (CR)	≈97.22mΩ	≈22.22mΩ	
Input terminal impedance	≈177.77KΩ			
Height	37U			
AC Input	Voltage	100~240Vac		
	Frequency	50/60Hz		
	Power	2250VA max		

*1. The voltage/current input is no less than 10%FS (FS indicates the full scope).

*2. The scope of read-back resistance is $(1/(1/R+(1/R)*0.01\%+0.08), 1/(1/R-(1/R)*0.01\%-0.08))$.

*3. The voltage/current input is no less than 10%FS.

*4. The load current value is no less than 4% of FS_CCH.

*5. The load current value is no less than 10% of FS_CCH.

4.2 Additional features

Memory capacity: 100 groups.

Recommended calibration frequency: 1 time/year.

Cooling method: fan.

5 References of Load Communication Interfaces

- ◆ RS-232 interface
- ◆ USB interface
- ◆ GPIB interface
- ◆ LAN Interface

This series electronic load is provided with four communication interfaces to communicate with a computer for selection, including RS–232, USB, GPIB and LAN. The customer can choose any one according to his demands.

5.1 RS-232 interface

Cable connection load with both ends of COM interface (DB9) and computer. Composite key **[Shift] + 8(System)** on front board can be used to enter system menu for activation.

In RS-232 interface, all SCPI commands can be used for programming. If RS-232 interface is selected, in accordance with internal connection of data terminal equipment (DTE) and data communication equipment (DCE) as defined in EIA RS-232, the load is connected to another DTE (e.g., PC COM interface) with direct-connected Modem cable.



Note

RS-232 setting in procedure should be consistent with that in system menu of front board. Press composite key **[Shift] + 8(System)** to change (if necessary). Send a ^C or ^X character string to the load to pause data transmission. It will clear any uncompleted operation and waive any uncompleted output.

RS-232 data format

RS-232 data comprises start bit, odd and even parity check bit, stop bit and 8-bit data bit. Start bit and stop bit are not editable. However, next odd or even item can be selected by front board **[Shift] + 8(System)**. The odd and even items are saved in NVM.

Baud rate

Through front board **[Shift] + 8(System)**, the user may select one Baud rate saved in NVM: 4800 /9600 /19200 /38400 /57600 /115200

RS-232 Connection

Use RS-232 cable with DB-9 interface because the RS-232 serial port can be connected controller (e.g. PC) serial port. Do not use modulating cable of air-conditioner. Refer to Table 2-2 for plug pin.

If your computer is provided with a RS-232 interface with DB-25 plug, a cable and a adapter with DB-25 plug (one end) and DB-9 plug (the other end) are required (not the modulating cable of the air-conditioner).

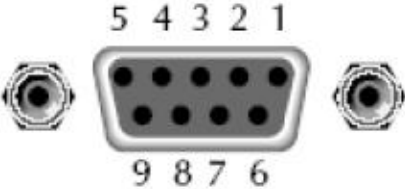
RS232 Pins of Plug	Pin number	Description
	1	No conjunction
	2	TXD, data transmission
	3	RXD, data receiving
	4	No conjunction
	5	GND, grounding
	6	No conjunction
	7	CTS, clear to send
	8	RTS, request to send
	9	No conjunction

RS-232 troubleshooting

In case of connection failure of RS-232, perform following check:

- Check if the computer and load are provided with same Baud rate, parity check bit, data bit and flow control. The power shall be configured with one start bit (fixed) and one stop bit (fixed).
- Just as described in the RS-232 connector, correct interface cable or adapter shall be adopted. Note: even if the cable is equipped with right plug, internal wiring may be incorrect.
- The interface cable must be connected to the correct serial port (COM1, COM2, etc.) of the computer.

Setting of communication

Before communication operation, be sure to match load and PC parameters (as follows).

Baud rate: 9600 (4800/9600/19200/38400/57600/15200). You may enter system menu through the board to set communication Baud rate.

Data bit: 8 bits

Stop bit: 1 bit

Check: none

Start Bit	8 Data Bits	Parity=None	Stop Bit
-----------	-------------	-------------	----------

5.2 USB interface

Connect the load and the computer using a cable with two USB interfaces (each end). All functions of the load can be programmed via USB.

The functions of load USB488 interface are as follows:

- The interface is 488.2 USB488 Interface.
- The interface receives requests of REN_CONTROL, GO_TO_LOCAL and LOCAL_LOCKOUT.
- The interface receives the command MsgID=TRIGGER USBTMC and conveys the TRIGGER command to the functional layer.

The functions of load USB488 device are as follows:

- Capable to read all common SCPI commands.
- SR1 enabled.
- RL1 enabled.
- DT1 enabled.

5.3 GPIB interface

Firstly, connect load GPIB interface and computer GPIB card through IEEE488 bus and ensure sufficient contact. Tighten them with screws. Set address. Load address range: 0 to 31. Press **[Shift] + 8**(System) to enter system menu functions. Press Left/Right key to find Communication. Select GPIB and set address. Input address and press **[Enter]** for confirmation. The load works by setting GPIB address on front board. GPIB address is saved in NVM.

5.4 LAN Interface

When the user connect PC through LAN interface, the following is required to use the LAN interface. The LAN interface complies with the LXI standard.

Connect Interface

Use the following steps to quickly connect your instrument to your LAN and configure it. Two typical LAN interface systems are described below: private LAN and site LAN.

- **Connect to the private LAN**

A private LAN is a network in which LAN-enabled instruments and computers are directly connected. They are typically small, with no centrally-managed resources. When connected to a computer, a standard network cable can be used to connect directly to the computer via the LAN interface.

- **Connect to the site LAN**

A site LAN is a local area network in which LAN-enabled instruments and computers are connected to the network through routers, hubs, and/or switches. They are typically large, centrally-managed networks with services such as DHCP and DNS servers. When connected to a computer, a network cable can be used to connect to the router, and the computer is also connected to the router.



Note

- When using one crossover cable to connect PC directly, the gateway address of the instrument should be consistent with that of the PC, and the IP address should be at the same network segment with the PC's IP address.
- When the instrument and computer are connected to the router, an independent IP address must be assigned for the instrument.

Configure LAN Interface Information

The configurable parameters of this series power system power supply load are described as follows.

IP-Conf

- IP: This value is the Internet Protocol (IP) address of the instrument. An IP address is required for all IP and TCP/IP communications with the instrument. An IP Address consists of 4 decimal numbers separated by periods. Each decimal number ranges from 0 through 255 with no leading zeros (for example, 169.254.2.20).

- **Mask:** This value is used to enable the instrument to determine if a client IP address is on the same local subnet. The same numbering notation applies as for the IP Address. When a client IP address is on a different subnet, all packets must be sent to the Default Gateway.
- **Gateway:** This value is the IP Address of the default gateway that allows the instrument to communicate with systems that are not on the local subnet, as determined by the subnet mask setting. The same numbering notation applies as for the IP Address. A value of 0.0.0.0 indicates that no default gateway is defined.
- **Socket Port:** This value indicates the port number corresponding to the service.

5.4.1 Using Web Server

The instrument has a built-in Web server for monitoring and controlling the instrument via a Web browser in PC. To use the Web server, connect the instrument and PC over LAN interface and enter the instrument's IP address into the address bar at the top of your PC's Web browser, you can access the front panel control functions including the LAN configuration parameters.



Note

The format of the address entered in the address bar of the browser is **http://192.168.0.100**. The specific IP address is subject to the actual instrument settings.

By default, the login password of the Web interface defaults to 12345678. To change the password, click the Security button in the navigation bar on the left side of the window after login.

Enter the password and then click the LOGIN button, the Web Interface will appear in the browser as shown below. The following figure is just as an example and the Web interface of different models are different. The actual shown page shall be subject to the connected instrument.

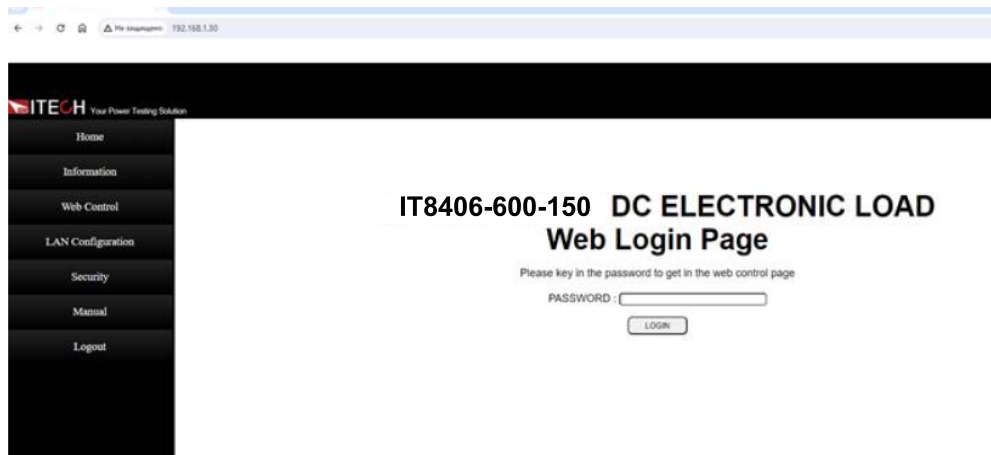

You can select different pages by clicking the buttons shown in the navigation bar on the left side of the window. The detailed descriptions are as follows.

- Home : Web home interface, displays the model and appearance of the instrument;
- Information: Displays the serial number of the instrument and more system information as well as LAN configuration parameters;
- Web Control: Enables the Web control to begin controlling the instrument. This page allows you to monitor and control the instrument;
- Security: change the password and control access to the Web interface;
- Manual: Go to the ITECH official website and view or download the relevant documents.
- Logout: logout the Web interface.

5.4.2 Using Sockets

CAUTION

- **Before using this function, you need to configure Socket Port, and the configuration on the instrument side should be consistent with the configuration on the PC side.**

ITECH instruments have SCPI socket services, which can be used to send and receive SCPI commands, queries, and query responses. All commands must be terminated with a newline for the message to be parsed. All query responses will also be terminated with a newline.

A Appendix

- ◆ Specifications of Red and Black Test Cables
- ◆ Fuse Replacement

A.1 Specifications of Red and Black Test Cables

ITECH provides you with optional red and black test cables, which are sold individually and you can select for test. For specifications of ITECH test cables and maximum current values, refer to the table below.

Model	Specification
IT-E30110-AB	1kV/10A/1m*2pcs Alligator clips-Banana plugs
IT-E30110-BB	1kV/10A/1m*2pcs Banana plugs-Banana plugs
IT-E30110-BY	1kV/10A/1m*2pcs Banana plugs-Y-type terminals
IT-E30312-YY	500V/30A/1.2m*2pcs Y-type terminals-Y-type terminals
IT-E30320-YY	500V/30A/2m*2pcs Y-type terminals-Y-type terminals
IT-E30615-OO	500V/60A/1.5m*2pcs Ring terminals-Ring terminals
IT-E31005LIC-OO	600V/100A/0.5m*2pcs Ring terminal low inductance
IT-E31010LIC-OO	600V/100A/1m*2pcs Ring terminal low inductance
IT-E31020LIC-OO	600V/100A/2m*2pcs Ring terminal low inductance
IT-E31040LIC-OO	600V/100A/2m*2pcs Ring terminal low inductance
IT-E31220-OO	500V/120A/2m*2pcs Ring terminals-Ring terminals
IT-E31250-OO	500V/120A/5m*2pcs Ring terminals-Ring terminals
IT-E32410-OO	500V/240A/1m*2pcs Ring terminals-Ring terminals
IT-E32420-OO	500V/240A/2m*2pcs Ring terminals-Ring terminals
IT-E32450-OO	500V/240A/5m*2pcs Ring terminals-Ring terminals
IT-E3301020-OO	3kV/100A/2m*2pcs Ring terminals-Ring terminals
IT-E3301050-OO	3kV/100A/5m*2pcs Ring terminals-Ring terminals
IT-E3302420-OO	3kV/240A/2m*2pcs Ring terminals-Ring terminals

IT-E3302450-OO	3kV/240A/5m*2pcs Ring terminals-Ring terminals
IT-E3303620-OO	3kV/360A/2m*2pcs Ring terminals-Ring terminals
IT-E3304020-OO	3kV/400A/2m*2pcs Ring terminals-Ring terminals
IT-E33620-OO	500V/360A/2m*2pcs Ring terminals-Ring terminals
IT-E33650-OO	500V/360A/5m*2pcs Ring terminals-Ring terminals
IT-E34020-OO	500V/400A/2m*2pcs Ring terminals-Ring terminals
IT-E34520-OO	500V/450A/2m*2pcs Ring terminals-Ring terminals
IT-E35030-OO	500V/360A/3m*2pcs Ring terminals-Ring terminals
IT-E36530-OO	500V/650A/3m*2pcs Ring terminals-Ring terminals

For maximum current of AWG copper wire, refer to table below.

AWG	8	10	12	14	16	18	20	22	24	26	28
The Maximum Current Value (A)	60	40	30	20	13	10	7	5	3.5	2.5	1.7



Note

- AWG (American Wire Gage), it means X wire (marked on the wire). The table above lists current capacity of single wire at working temperature of 30°C. For reference only.
- Along with temperature, you must also consider voltage drop when selecting wire sizes.

Although the instrument will compensate for the voltage in the wires, it is recommended to minimize the voltage drop as much as possible to prevent excessive power consumption from the instrument and poor dynamic response to load changes. Larger diameter wire sizes will help minimize wire voltage drops. Twisting or bundling wires will help reduce transient voltage drops.

A.2 Fuse Replacement



Different models of our company product are supplied with different fuse assembly. The way to replace the fuse changes accordingly. The common ways are

as follows. Please choose the corresponding way of disassembly and replacement based on the fuse assembly of the actual instrument.

**Note**

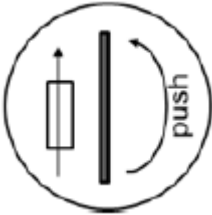
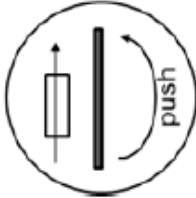
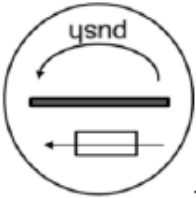
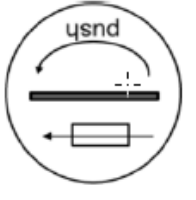
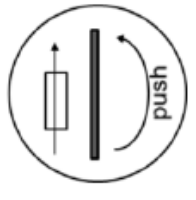
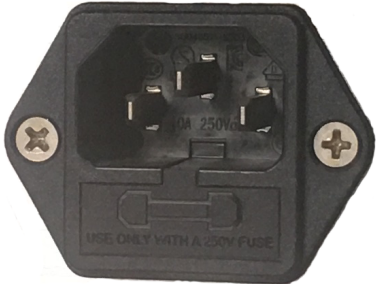
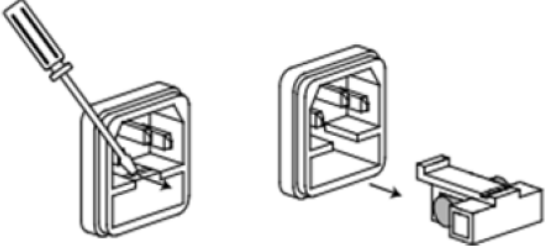
If there are no fuse assembly on the instrument rear panel, it means that you can't replace the fuse by yourself. Please contact the ITECH engineer on the condition of the same malfunction.

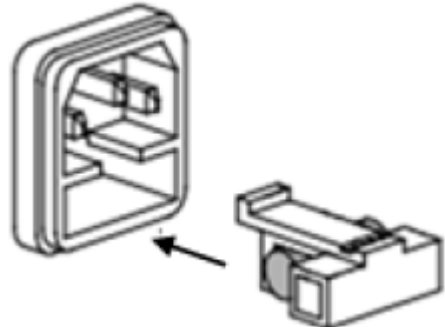
The type of the fuse	The way to replace
	<ol style="list-style-type: none"> 1. Use a screwdriver to push and turn the fuse box anti-clockwise. When turned to 90 degrees, release the screwdriver. Refer to the picture below.   <ol style="list-style-type: none"> 2. The fuse box will bounce up, then you can see the fuse in it. Take out the blown fuse. 3. Please replace with a fuse of the same specification. Refer to the technical specification of the corresponding instrument. 4. When install, put into the fuse box as the picture below. Then use a screwdriver to push and turn the fuse box to 90 degrees clockwise. Refer to the picture below.  
	<p>The power cord jack of the instrument includes the fuse. Please refer to the rear panel introduction of the corresponding instrument for the detailed position. The replacement steps for this type of the fuse are as follows.</p> <ol style="list-style-type: none"> 1. First pull out the power cord, and then take out the fuse block from the power cord jack with a small screwdriver, as shown below.  <ol style="list-style-type: none"> 2. Have a visual inspection of the fuse to see whether it is burnt out; if yes, replace it with another fuse of the same specification. Refer to the corresponding technical specifications for fuse rating.

The type of the fuse	The way to replace
	<p>3. After replacement, mount the fuse block to the original position, as illustrated below.</p> 
	<ol style="list-style-type: none"> 1. Push and turn the fuse box anti-clockwise by hand. When turned to 90 degrees, release the screwdriver. 2. The fuse box will bounce up, then you can see the fuse in it. Take out the blown fuse. 3. Please replace with a fuse of the same specification. Refer to the technical specification of the corresponding instrument. 4. When install, put into the fuse box firstly. Then Push and turn the fuse box to 90 degrees clockwise.

Connect with us

Thank you for purchasing ITECH products. Any questions, pls. feel free to let us know.

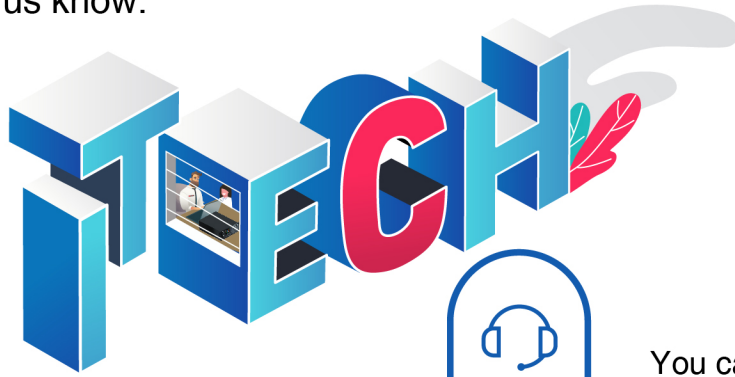

You can chat with us on ITECH website



For more information, pls. visit www.itechate.com



Click and follow ITECH Electronics

