

**Anritsu** Advancing beyond

**VectorStar™**

High Performance, Broadband Network Analysis Solutions

# ME7838D Series Vector Network Analyzers

Broadband VNA System

70 kHz to 145 GHz (150 GHz)

Millimeter Waveguide VNA System

50 GHz to 1.1 THz

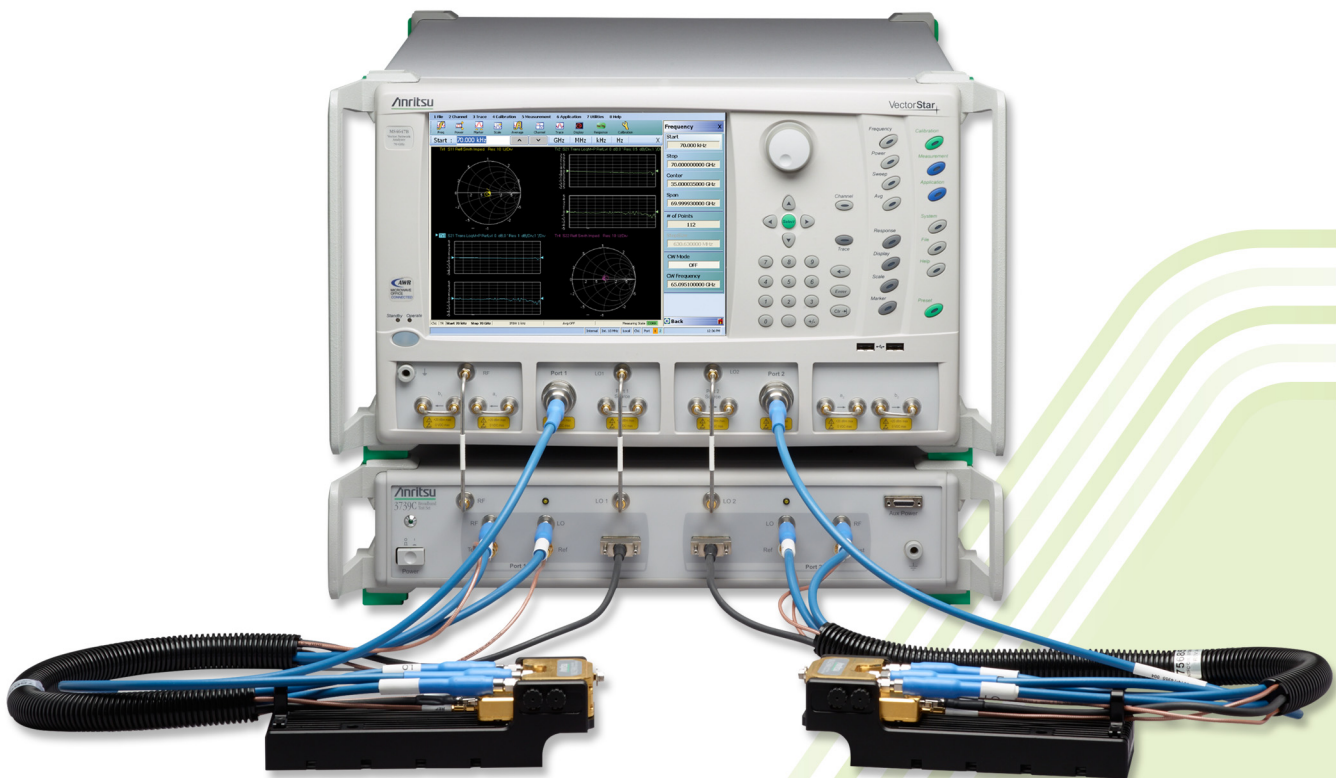

## ME7838D Introduction

Through the use of the Anritsu-developed 0.8 mm coaxial connector, frequencies up to 145 GHz can be propagated within a coaxial transmission line without waveguide flange connections. A broadband frequency sweep from 70 kHz to 145 GHz is now available without the need to concatenate multiple systems (operational from 40 kHz to 150 GHz). The result is more accurate device characterization from near-DC through the W band and F band frequencies. W band devices can now be characterized beyond the operating frequency of the application for more accurate modeling and higher success rate from the first design turn. The ME7838D fully supports the 3744A-Rx 30 GHz to 125 GHz receiver for noise figure measurements up to 125 GHz. Integrating Anritsu's unique strength in nonlinear transmission line technology (NLTL), the ME7838D system offers many advances in broadband performance over traditional systems including:

- Industry-best broadband frequency coverage, starts at 70 kHz instead of 10 MHz and is operational from 40 kHz to 145 GHz through a single coaxial connector
- Industry-best dynamic range, 120 dB at 10 MHz, 108 dB at 65 GHz, 108 dB at 110 GHz, and 94 dB at 145 GHz
- Industry-best measurement speed, 55 ms for 201 points at 10 kHz IFBW
- Compact, lightweight mmWave modules for easy, precise, and economical positioning on the wafer probe station, 0.7 lb and 1/50 the volume of traditional mmWave modules
- The first millimeter-wave system with real time leveling of power without the need for calibration software correction tables
- Industry-best calibration and measurement stability, 0.1 dB over 24 hrs
- Fully supports tri-axial Kelvin bias tee connections for on-wafer device biasing up to 145 GHz
- Millimeter-wave waveguide coverage to 1.1 THz
- The ME7838AX 125 GHz Broadband system can be easily upgraded to 145 GHz by incorporating the Anritsu MA25300A mmWave module

## Broadband VNA System 70 kHz to 145 GHz

The ME7838D broadband VNA system provides single sweep coverage from 70 kHz to 145 GHz and is operational from 40 kHz to 145 GHz. It consists of the following items:

- MS4647B VectorStar™ VNA, 70 kHz to 70 GHz with Option 7, Option 70, and Option 80/81
- 3739C Broadband Millimeter-Wave Test Set and Interface Cables
- MA25300A Millimeter-Wave Module, 2 each

## Millimeter Waveguide VNA System 50 GHz to 1.1 THz

The ME7838D Millimeter-wave configuration provides waveguide output from 50 GHz to 1.1 THz in waveguide bands. The system can extend the broadband system or be configured to operate only as a waveguide system. It consists of the following items:

- MS4647B VectorStar™ VNA, 70 kHz to 70 GHz with Option 7, and Option 82/83
- 3739C Broadband Millimeter-Wave Test Set and Interface Cables
- Millimeter-Wave Module, 2 each

## Broadband/Millimeter-Wave System Options

- MS4640B-002 – Time Domain
- MS4640B-021 – Universal Fixture Extraction
- MS464xB-031 – Dual Source Architecture
- MS464xB-032 – Internal RF Combiner
- MS4640B-035 – IF Digitizer
- MS4640B-036 – Extended IF Digitizer Memory
- MS4640B-041 – Noise Figure
- MS4640B-042 – PulseView™
- MS4640B-043 – DifferentialView™
- MS4640B-044 – IMDView™
- MS4640B-046 – Fast CW
- MS4640B-047 – Eye Diagram
- MS4640B-048 – Differential Noise Figure
- MS4640B-049 – Spectrum Analysis
- MS464xB-051 – External VNA Direct Access Loops
- MS464xB-061 – Active Measurement Suite, with 2 Attenuators
- MS464xB-062 – Active Measurement Suite, with 4 Attenuators
- 3744A-Rx – 30 to 110 GHz mmWave Receiver for Noise Figure and mmWave Antenna Measurements
- 3744A-EE – 56 to 95 GHz WR-12 Waveguide Module
- 3744A-EW – 65 to 110 GHz WR-10 Waveguide Module
- SC8215 and SC7287 – Kelvin Bias Tees

A detailed color brochure available on the Anritsu web site provides descriptions and examples of the VectorStar family's features and benefits:

<https://www.anritsu.com/test-measurement/products/ms4640b-series>

**Table of Contents**

Definitions.....3  
 Specifications for Broadband Configuration.....4  
 Broadband Measurement Examples .....11  
 Specifications for Waveguide Band Configuration.....15  
 ME7838D with Option 41/48 and 3744A-Rx mmWave Noise Figure Measurements .....21  
 VectorStar ME7838D Waveguide Bands from 50 GHz to 1.1 THz .....23  
 Standard Capabilities for All Configurations.....27  
 Mechanical and Environmental.....27  
 Regulatory Compliance.....27  
 Warranty.....27  
 Calibration and Correction Capabilities .....28  
 Mechanical Calibration/Verification Kits .....29  
 Test Port Cables.....30  
 Precision Adapters, Attenuators, and Other Components.....30  
 Ordering Information.....31

**Definitions**

	All specifications and characteristics apply under the following conditions, unless otherwise stated:
Warm-Up Time	After 90 minutes of warm-up time, where the instrument is left in the ON state.
Temperature Range	Over the 25 °C ± 5 °C temperature range.
Error-Corrected Specifications	For error-corrected specifications, over 23 °C ± 3 °C, with < 1 °C variation from calibration temperature. For error-corrected specifications are warranted and include guard bands, unless otherwise stated.
Typical Performance	"Typical" specifications describe expected, but not warranted, performance based on sample testing. Typical performance indicates the measured performance of an average unit and do not guarantee the performance of any individual product. "Typical" specifications do not account for measurement uncertainty and are shown in parenthesis, such as (-102 dB), or noted as Typical.
User Cables/Adapters	Specifications do not include effects of any user cables, adapters, fixtures or other structures attached to the instrument.
Discrete Spurious Responses	Specifications may exclude discrete spurious responses.
Internal Reference Signal	All specifications apply with internal 10 MHz Crystal Oscillator Reference Signal.
Characteristic Performance	Characteristic performance indicates a performance designed-in and verified during the design phase. It does include guard-bands and is not covered by the product warranty.
Below 300 kHz	All uncertainties below 300 kHz are typical.
Recommended Calibration Cycle	12 months
Interpolation Mode	All specifications are with Interpolation Mode Off.
Specifications Subject to Change	All specifications subject to change without notice.
Patents	The instrument may be protected by one or more of the following patents: 6894581, 7088111, 7545151, 7683633, 7924024, 8185078, 8306134, 8417189, 8718586, 9103873, 9606212, 9753071, 10225073, 10778592, 10225073 depending on the model and option configuration of the instrument. For the most current data sheet, please visit the Anritsu web site at <a href="http://www.anritsu.com">www.anritsu.com</a> .

## Specifications for Broadband Configuration

### ME7838D Broadband Hardware Configuration

The ME7838D broadband VNA system provides single sweep coverage from 70 kHz to 145 GHz and is operational from 40 kHz to 145 GHz. It consists of the following items:

VNA	MS4647B <sup>a</sup> VectorStar VNA, 70 kHz to 70 GHz with Option 7, Option 70, and Option 80/81
Test Set	3739C Broadband Test Set and interface cables
mmWave Modules	MA25300A Millimeter-Wave Module, 2 each

a. Support for the MS464xA VectorStar is available.

### ME7838D Broadband/Millimeter-Wave System Options

The major ME7838D broadband VNA system options are:

Option 2	MS4640B-002 – Time Domain
Option 21	MS4640B-021 – Universal Fixture Extraction
Option 31	MS464xB-031 – Dual Source Architecture
Option 32	MS464xB-032 – Internal RF Combiner
Option 35	MS4640B-035 – IF Digitizer
Option 36	MS4640B-035 – Extended IF Digitizer Memory
Option 41	MS4640B-041 – Noise Figure
Option 42	MS4640B-042 – PulseView™
Option 43	MS4640B-043 – DifferentialView™
Option 44	MS4640B-044 – IMDView™
Option 46	MS4640B-046 – Fast CW
Option 47	MS4640B-047 – Eye Diagram
Option 48	MS4640B-048 – Differential Noise Figure
Option 49	MS4640B-049 – Spectrum Analysis
Option 51	MS464xB-051 – External VNA Direct Access Loops
Option 61	MS464xB-061 – Active Measurement Suite, with 2 Attenuators
Option 62	MS464xB-062 – Active Measurement Suite, with 4 Attenuators
Bias Tees	SC8215 and SC7287 – Kelvin Bias Tees

### System and Receiver Dynamic Range, Noise Floor (Excludes localized spurious responses and crosstalk)

System Dynamic Range	System dynamic range is measured as the difference between maximum port power and the RMS noise floor in a 10 Hz bandwidth and no averaging (ports terminated).
Noise Floor	Noise floor is calculated as the difference between maximum rated port power and system dynamic range.
Receiver Dynamic Range	Receiver Dynamic Range is calculated as the difference between the receiver compression level and the noise floor at Ports 1 or 2.
Normalizing Measurement	Normalizing measurement made with a through line connection, with its effects compensated for. The cables between the VNA and the MA25300A modules are assumed to be the 806-206-R 1.85 mm cable (61 cm, 24 in long) or the 806-209-R 1.85 mm cable (91.5 cm, 36 in long). All values are typical.

Frequency (GHz)	System Dynamic Range (dB) <sup>a</sup>		Receiver Dynamic Range (dB) <sup>a</sup>		Noise Floor (dBm) <sup>a</sup>	
	ME7838D	ME7838D Option 62	ME7838D	ME7838D Option 62	ME7838D	ME7838D Option 62
70 kHz to 300 kHz	93	90	89	86	-83	-82
> 0.3 to 2 MHz	103	100	103	102	-93	-92
> 2 to 10 MHz	115	112	115	114	-105	-102
> 0.01 to < 2.5	120	116	121	122	-110	-109
2.5 to 24	110	105	121	121	-110	-108
> 24 to 54	110	107	125	125	-115	-115
> 54 to 60	110	110	124	124	-114	-114
> 60 to 67	110	110	123	123	-113	-113
> 67 to 80	108	108	121	121	-111	-111
> 80 to 85	106	106	123	123	-113	-113
> 85 to 90	106	106	122	122	-112	-112
> 90 to 95	106	106	121	121	-111	-111
> 95 to 105	106	106	121	121	-111	-111
> 105 to 110	109	109	125	125	-115	-115
> 110 to 120	108	108	118	118	-111	-111
> 120 to 125	104	104	116	116	-109	-109
> 125 to 140	92	92	109	109	-102	-102
> 140 to 145	94	94	107	107	-100	-100

a. Excludes localized spurious responses and crosstalk.

**Test Port Power, Receiver Compression**

Port power control is provided by the base VNA for frequencies below 54 GHz, and by the MA25300A mmWave module for frequencies greater than 54 GHz. Receiver compression point is defined as the port power level beyond which the response may be compressed more than 0.2 dB relative to normalization level. 10 Hz IF bandwidth used to remove high level noise effects. All typical.

Frequency (GHz)	Port Power (dBm)		Receiver Compression <sup>a</sup>	
	Max Power ME7838D	Max Power ME7838D Option 62 <sup>b</sup>	Compression ME7838D	Compression ME7838D Option 62
70 kHz to 300 kHz	10	8	6	6
> 0.3 to 2 MHz	10	8	10	12
> 2 to 10 MHz	10	10	10	12
> 0.01 to < 2.5	10	7	11	13
2.5 to 24	0	-3	11	13
> 24 to 54	-5	-8	10	10
> 54 to 60	-4	-4	10	10
> 60 to 67	-3	-3	10	10
> 67 to 80	-3	-3	10	10
> 80 to 85	-7	-7	10	10
> 85 to 90	-6	-6	10	10
> 90 to 95	-5	-5	10	10
> 95 to 105	-5	-5	10	10
> 105 to 110	-6	-6	10	10
> 110 to 120	-3	-3	7	7
> 120 to 125	-5	-5	7	7
> 125 to 140	-10	-10	7	7
> 140 to 145	-6	-6	7	7

- a. Using the 806-206-R 1.85 mm (61 cm, 24 in long) test port cables between the VNA and the MA25300A mmWave modules.
- b. Use this column also for Options 51 and 61 although the performance between 10 MHz and 54 GHz will characteristically be better by 1 dB or more for Option 51, and will characteristically be better by 1 dB or more for Option 61 (with port 1 driving and port 2 receiving).

**Power Range, Accuracy, Linearity, and Resolution**

Accuracy is defined at -10 dBm or max rated power, whichever is lower. Linearity is defined as the port power linearity error between the accuracy test power level and 5 dB below. Typical.

Frequency Range	Range (dBm)		Accuracy (dB)	Linearity (dB)	Resolution (dB)
	ME7838D	ME7838D Option 62			
70 kHz to 300 kHz	-25 to +10	-85 to +8	±1.5	±1.5	0.01
> 0.3 to 2 MHz	-25 to +10	-85 to +8	±1.5	±1.5	0.01
> 2 to 10 MHz	-25 to +10	-85 to +10	±1.5	±1.5	0.01
> 0.01 to < 2.5	-25 to +10	-85 to +8	±1.0	±1.0	0.01
2.5 to 24	-25 to 0	-85 to -3	±1.0	±1.0	0.01
> 24 to 54	-30 to -5	-90 to -8	±1.5	±1.0	0.01
> 54 to 60	-55 to -4	-55 to -4	±2.0	±1.5	0.01
> 60 to 67	-55 to -3	-55 to -3	±2.0	±1.5	0.01
> 67 to 80	-55 to -3	-55 to -3	±2.0	±1.5	0.01
> 80 to 85	-55 to -7	-55 to -7	±2.0	±1.5	0.01
> 85 to 90	-55 to -6	-55 to -6	±2.0	±1.5	0.01
> 90 to 95	-55 to -5	-55 to -5	±2.0	±1.5	0.01
> 95 to 105	-55 to -5	-55 to -5	±3.0	±2.0	0.01
> 105 to 110	-55 to -6	-55 to -6	±3.0	±2.0	0.01
> 110 to 120	-55 to -3	-55 to -3	±4.0	±3.0	0.01
> 120 to 125	-55 to -5	-55 to -5	±4.0	±3.0	0.01
> 125 to 140	-50 to -10	-50 to -10	±5.0	±4.0	0.01
> 140 to 145	-50 to -6	-50 to -6	±5.0	±4.0	0.01

**High Level Noise**

Noise measured at 1 kHz IF bandwidth, at maximum power or compression limit (whichever is less), with through transmission. RMS. Typical.

Frequency (GHz)	Magnitude (dB)	Phase (deg.)
70 kHz to 500 kHz	< 0.04	< 0.4
> 0.5 to 2 MHz	< 0.005	< 0.05
> 2 to 10 MHz	< 0.005	< 0.05
> 0.01 to < 2.5	< 0.005	< 0.05
2.5 to 24	< 0.006	< 0.06
> 24 to 54	< 0.005	< 0.06
> 54 to 80	< 0.005	< 0.06
> 80 to 110	< 0.008	< 0.09
> 110 to 120	< 0.008	< 0.09
> 120 to 125	< 0.011	< 0.11
> 125 to 140	< 0.016	< 0.16
> 140 to 145	< 0.016	< 0.16

**Stability**

Measurement ratio at maximum leveled power and with nominally a full coaxial reflect or a stable coaxial thru over the normal specified temperature range. (23 °C ±3°C Typical)

Frequency (GHz)	Magnitude (dB/°C)	Phase (deg./°C)
70 kHz to 300 kHz	< 0.015	< 0.1
> 0.3 to 2 MHz	< 0.015	< 0.05
> 2 to 10 MHz	< 0.01	< 0.05
> 0.01 to < 2.5	< 0.01	< 0.05
2.5 to 30	< 0.01	< 0.09
> 30 to 54	< 0.01	< 0.07
> 54 to 80	< 0.015	< 0.1
> 80 to 110	< 0.015	< 0.15
> 110 to 120	< 0.02	< 0.2
> 120 to 125	< 0.025	< 0.2
> 125 to 140	< 0.03	< 0.35
> 140 to 145	< 0.04	< 0.5

**Frequency Resolution, Accuracy, and Stability**

Resolution	Accuracy	Stability
1 Hz	$\pm 5 \times 10^{-7}$ Hz/Hz (at time of calibration)	$< 5 \times 10^{-9}/^{\circ}\text{C}$ over 0 °C to 50 °C temperature < $1 \times 10^{-9}$ /day aging, instrument on

**Uncorrected (Raw) Port Characteristics**

Typical performance with either ME7838D or ME7838D with Option 62.

Frequency Range	Directivity (dB)	Port Match (dB)
70 kHz to 10 MHz	10 <sup>a</sup>	8
> 0.01 to < 2.5 GHz	9 <sup>a</sup>	10
2.5 to 30 GHz	5 <sup>a</sup>	11
> 30 to 40 GHz	9 <sup>a</sup>	11
> 40 to 54 GHz	9 <sup>a</sup>	11
> 54 to 80 GHz	9	10
> 80 to 110 GHz	5	7
> 110 to 120 GHz	5	7
> 120 to 125 GHz	5	7
> 125 to 140 GHz	5	7
> 140 to 145 GHz	5	6

a. Raw directivity is degraded below 300 kHz, 2.2 to 2.5 GHz and in narrow bands within 10 to 34 GHz.

**Corrected System Performance and Uncertainties – SOLT/SSST**

With 12-term broadband calibration (concatenated SOLT and Triple Offset Short Calibration (SSST)), using the 3659 0.8 Calibration Kit. Cable flexure and drift effects are not included. Typical.

Frequency Range	Directivity (dB)	Source Match (dB)	Load Match (dB)	Reflection Tracking (dB)	Transmission Tracking (dB)
70 kHz to 10 MHz	36	36	36	± 0.1	± 0.1
> 0.01 to < 2.5 GHz	38	41	38	± 0.05	± 0.05
2.5 to 20 GHz	40	41	40	± 0.05	± 0.05
> 20 to 67 GHz	35	41	35	± 0.05	± 0.07
> 67 to 80 GHz	35	38	35	± 0.05	± 0.07
> 80 to 95 GHz	35	40	35	± 0.05	± 0.07
> 95 to 110 GHz	34	37	34	± 0.05	± 0.07
> 110 to 125 GHz	30	34	30	± 0.07	± 0.09
> 125 to 140 GHz	28	28	28	± 0.09	± 0.11
> 140 to 145 GHz	26	28	26	± 0.11	± 0.13

**Measurement Uncertainties – SOLT/SSST**

The graphs give measurement uncertainties after the above calibration. The component uncertainties are combined based on their characteristics: residual directivity, load and source match, tracking, network analyzer dynamic accuracy and connector repeatability are assumed to be fully correlated while noise effects (high level noise and noise floor effects) are assumed to be internally uncorrelated and uncorrelated with the first group of terms. 10 Hz IF Bandwidth is used. For transmission uncertainties, it is assumed that  $S_{11} = S_{22} = 0$ . For reflection uncertainties, it is assumed that  $S_{21} = S_{12} = 0$ . For other conditions, please use our free Exact Uncertainty calculator software, downloadable from the Anritsu web site at [www.anritsu.com](http://www.anritsu.com).

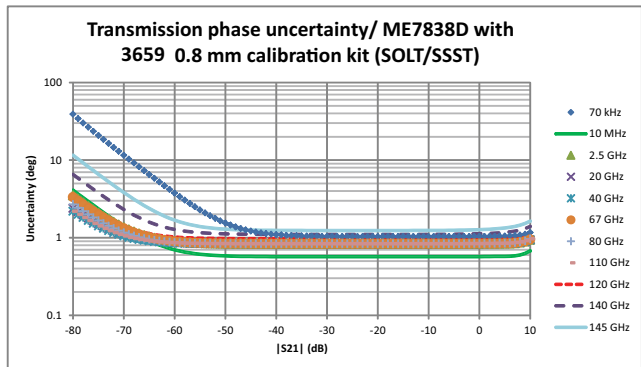
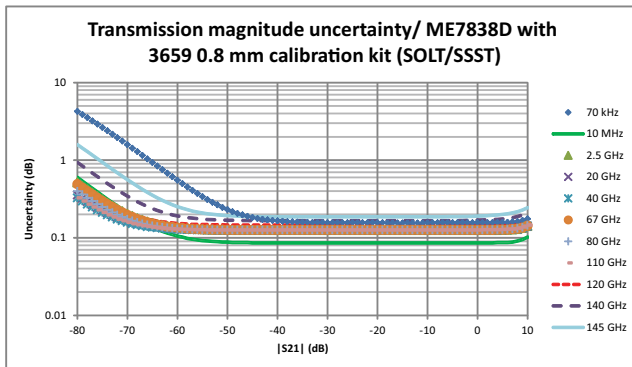
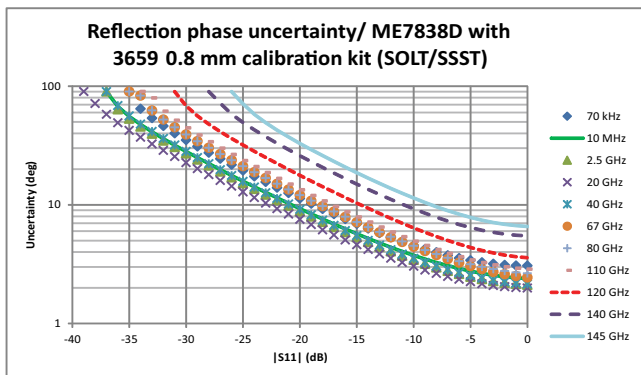
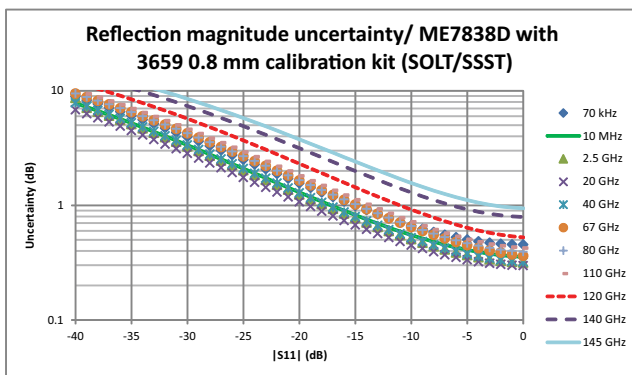

**Corrected System Performance and Uncertainties - LRL/LRM**

With 12 term LRL/LRM calibration using on-wafer substrate standards. Typical. Based on a typical vendor supplied impedance standard substrate.

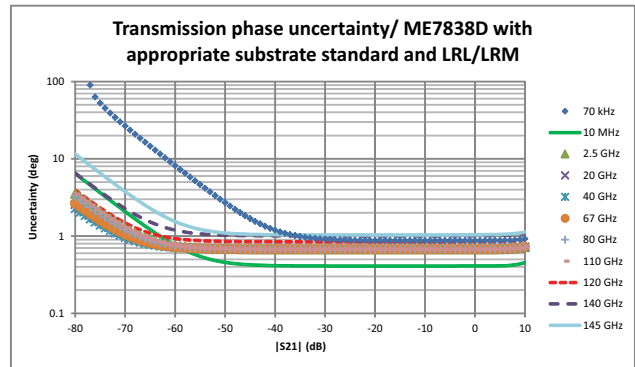
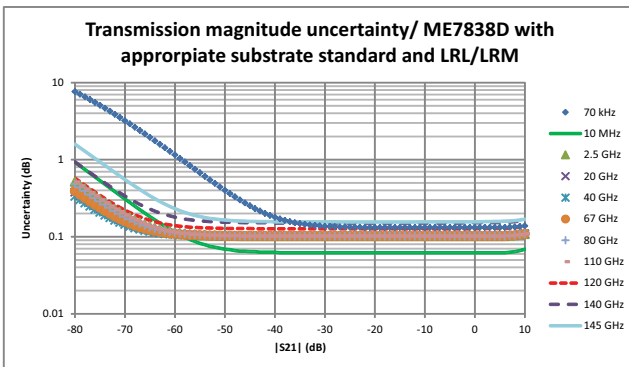
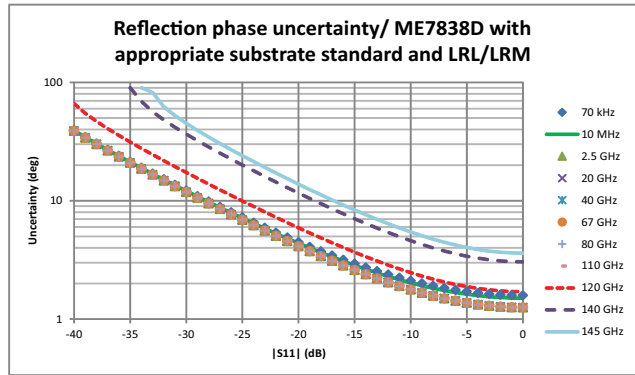
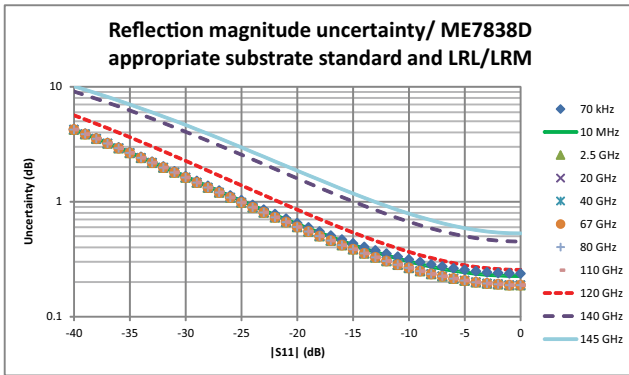

**Measurement Time**

Measurement times include sweep time, retrace time, and band-switching time. Typical.

**Measurement Time (ms)**

Full Band, 70 kHz to 145 GHz, Display ON, and ALC ON.

Calibration	IFBW	Measurement Time (ms) <sup>a</sup>			
		401 Points	1,601 Points	10,001 Points	25,000 Points
1-port calibration	1 MHz	80	100	350	700
	30 kHz	90	160	600	1500
	10 kHz	110	240	1100	2600
	1 kHz	470	1600	10,000	25,000
	10 Hz	47,000	160,000	1,000,000	2,500,000
2-port calibration	1 MHz	160	200	700	1400
	30 kHz	180	320	1200	3000
	10 kHz	220	480	2200	5200
	1 kHz	940	3200	20,000	50,000
	10 Hz	94,000	320,000	2,000,000	5,000,000

a. Measurement times are for ME7838D Broadband and ME7838D Millimeter-Wave Systems.

**Measurement Time (ms) vs. System Dynamic Range (dB)**

Full Band, Display ON, and ALC ON.

Calibration	401 Points Measurement Time	Achieved System Dynamic Range (Opt 062 at 54 GHz)	IFBW and Averaging Used
Uncorrected or 1-port calibration	110	77	10 kHz/no avg
	470	87	1 kHz/no avg
2-port calibration	220	77	10 kHz/no avg
	940	87	1 kHz/no avg

Block Diagram – ME7838D Broadband VNA System

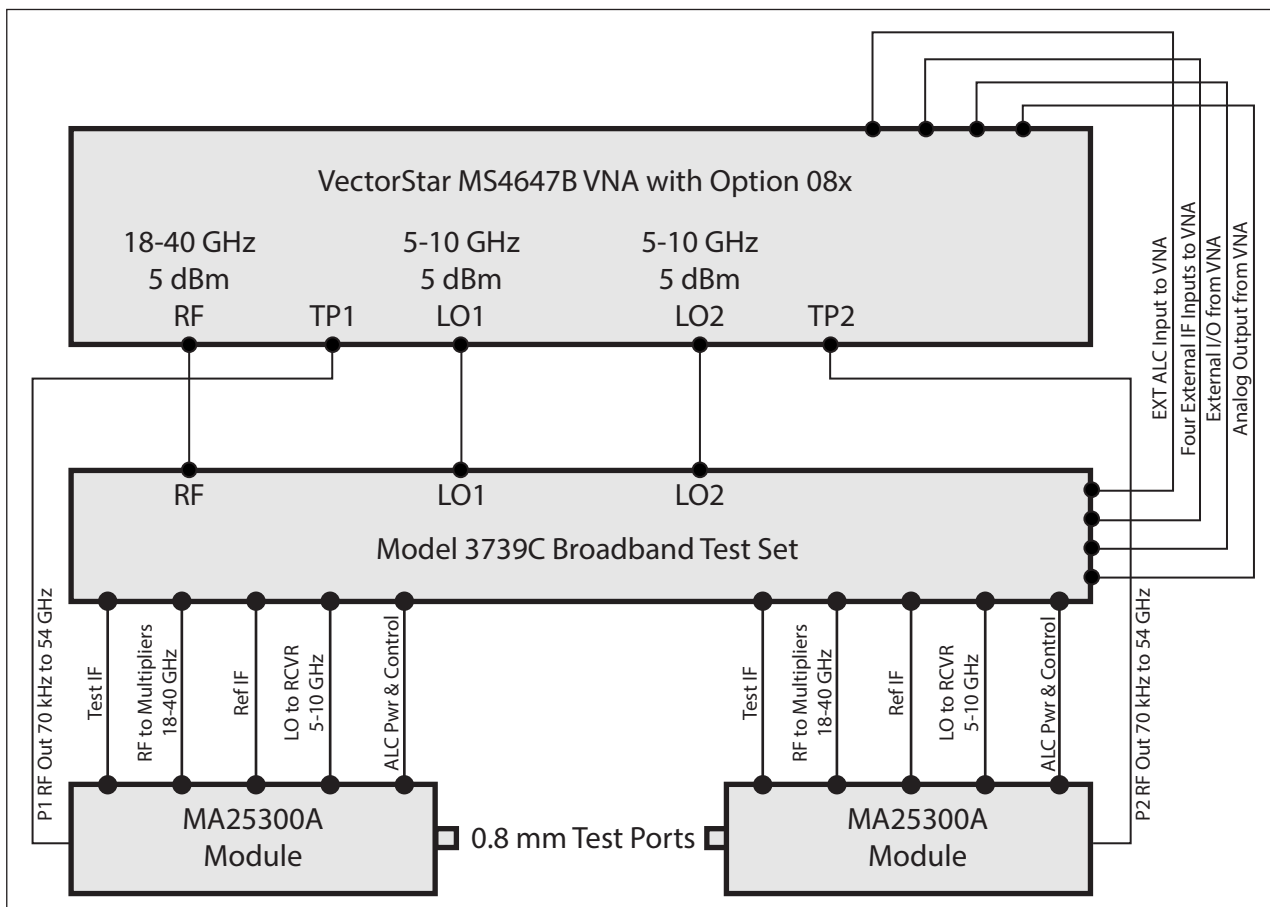

Broadband Configuration Block Diagram

**SC8215 and SC7287 Kelvin Bias Tees**

When connected to the Source input of the MA25300A module, provides Sense and Force SMC connections 1.5 in from the test port to minimize the IR drops associated with the impedances between the bias tee and the DUT.

Part Number	Description	Voltage	Current
SC8215	The SC8215 is a V-connectorized bias tee usable with the mmWave modules in the ME7838D for system frequencies of 70 kHz to 145 (150) GHz. Stand-alone, it is usable to 70 GHz.	Max Voltage: 16 VDC	Max Current: 100 mA
SC7287	The SC7287 is a V-connectorized bias tee usable with the mmWave modules in the ME7838D for system frequencies of 100 MHz to 145 (150) GHz. Stand-alone, it is usable to 70 GHz.	Max Voltage: 50 VDC	Max Current: 500 mA
Tri-Axial Output SMUs	For applications requiring Source Measure Units (SMU) with tri-axial outputs, a tri-axial (male) to SMC (male) cable is available, with the inner-shield isolated from ground at the bias tee SMC end, to float at the SMU guard potential. Check the accessories list for ordering information <a href="#">on page 35</a> .		

Broadband Measurement Examples

The following figures are typical measurement examples of the ME7838D Broadband system performance.

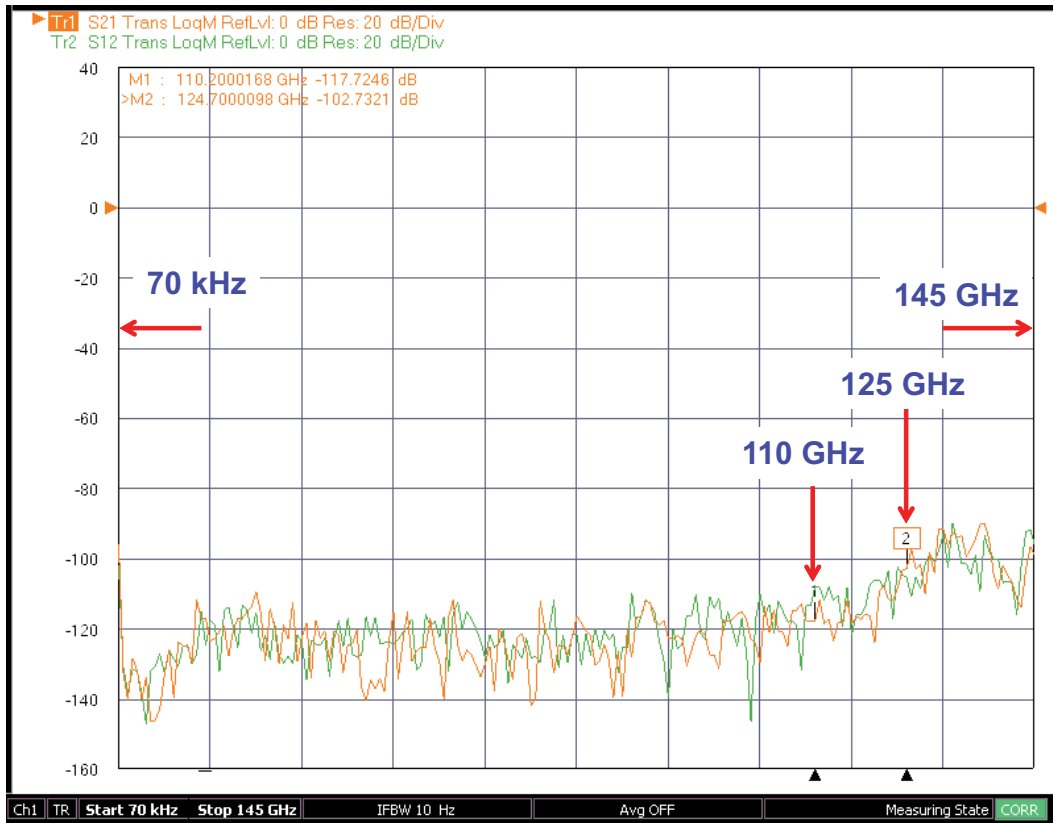

Typical dynamic range of ME7838D system at the 0.8 mm coaxial test port from 70 kHz to 145 GHz.

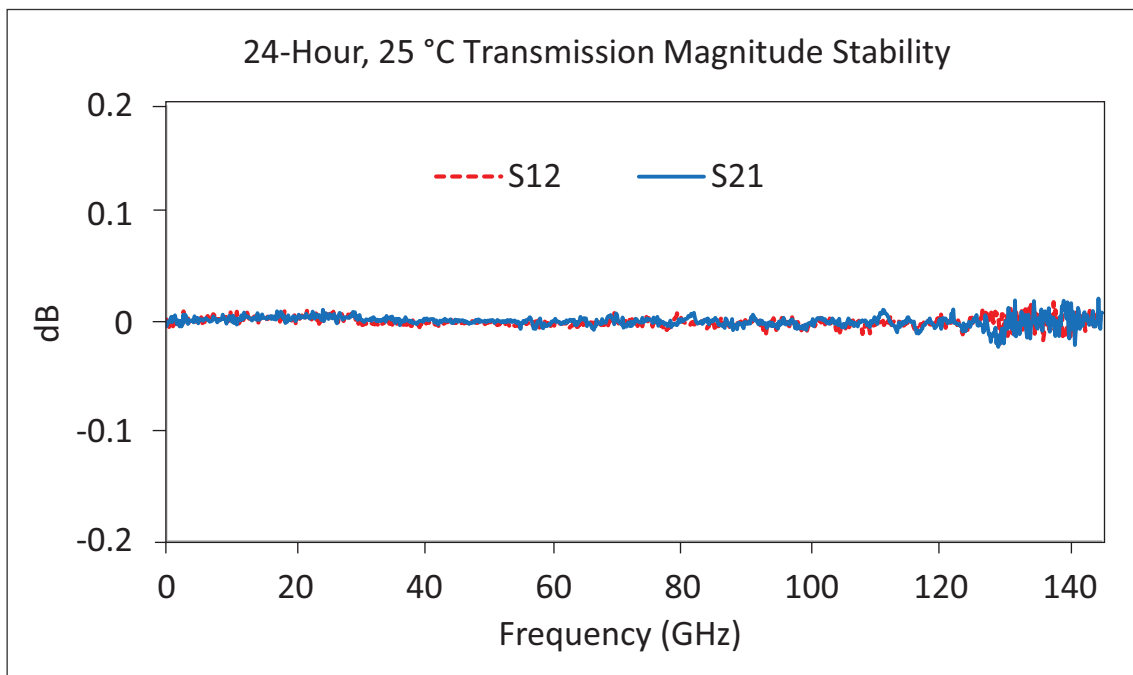

Typical Example 24-Hour Transmission Magnitude Stability

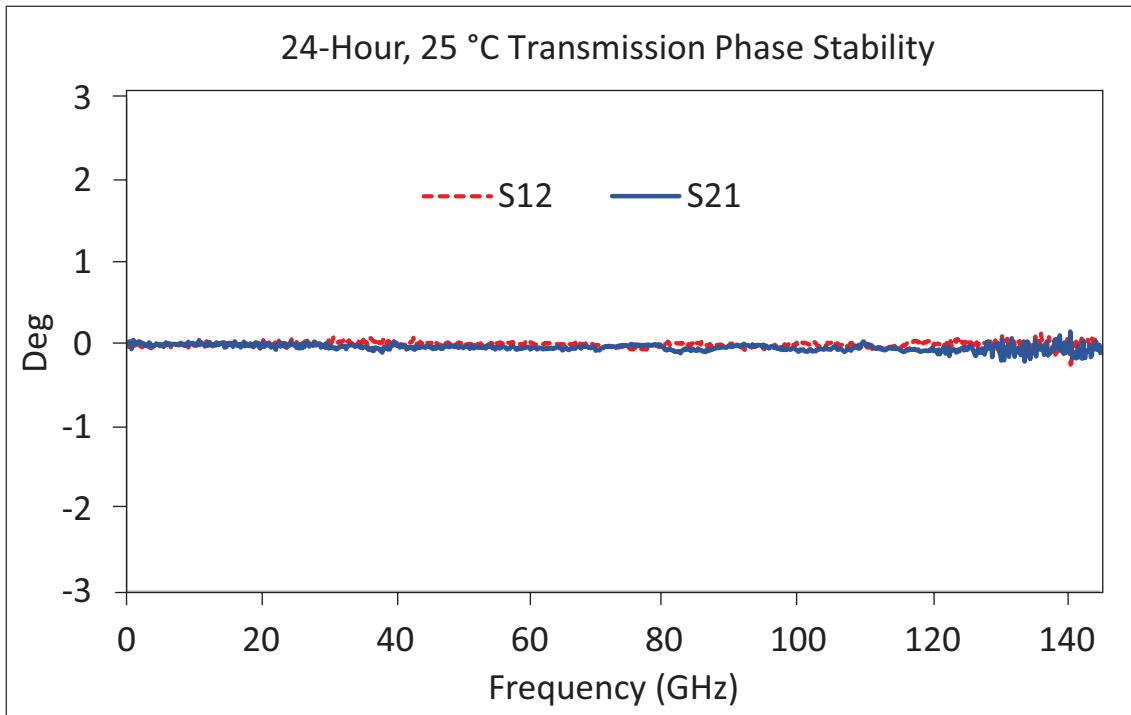

Typical Example 24-Hour Transmission Phase Stability

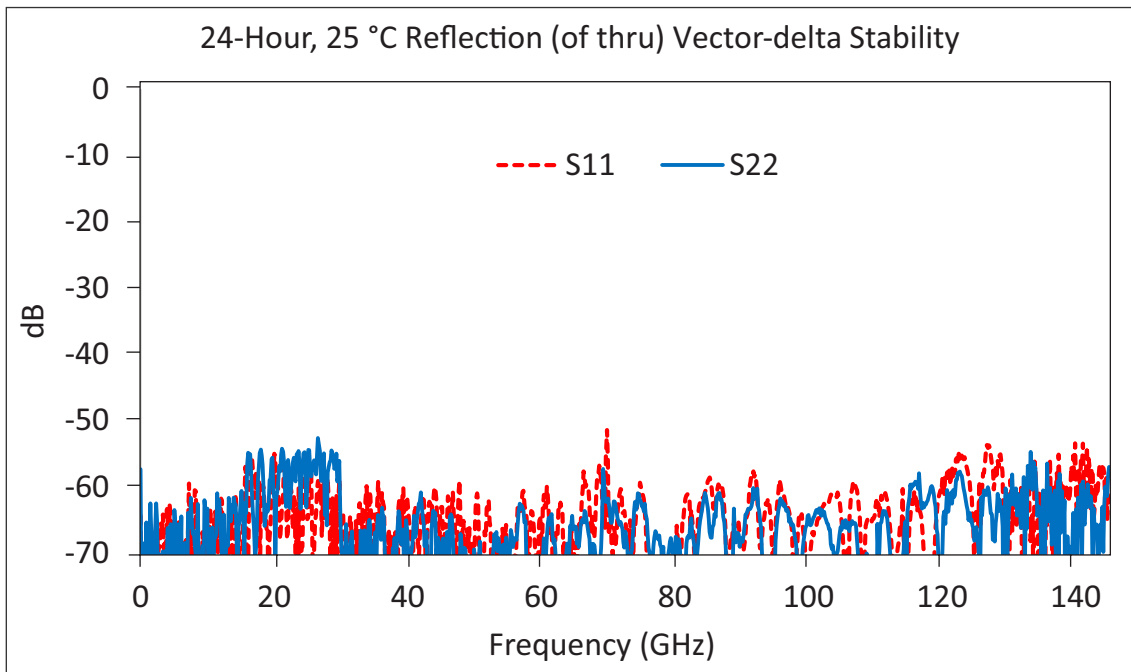

Typical Example 24-Hour Thru Line Match Vector-delta Stability

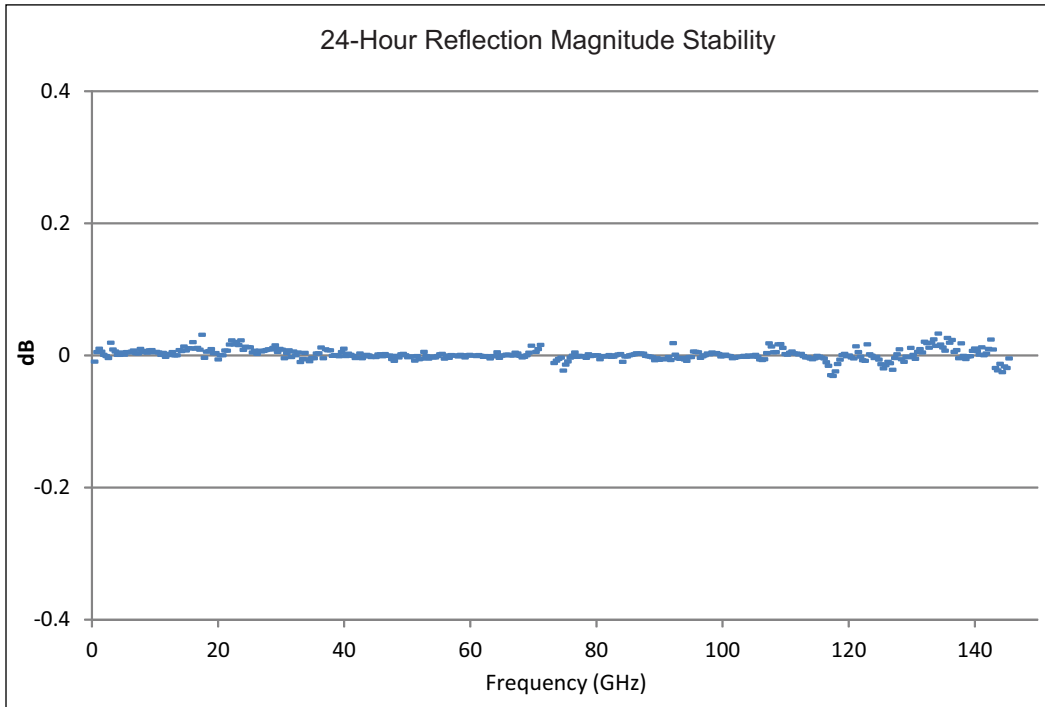

Typical 24-hour reflection magnitude stability from 70 kHz to 145 GHz in a typical lab environment when measured at 23 °C ±3°C.

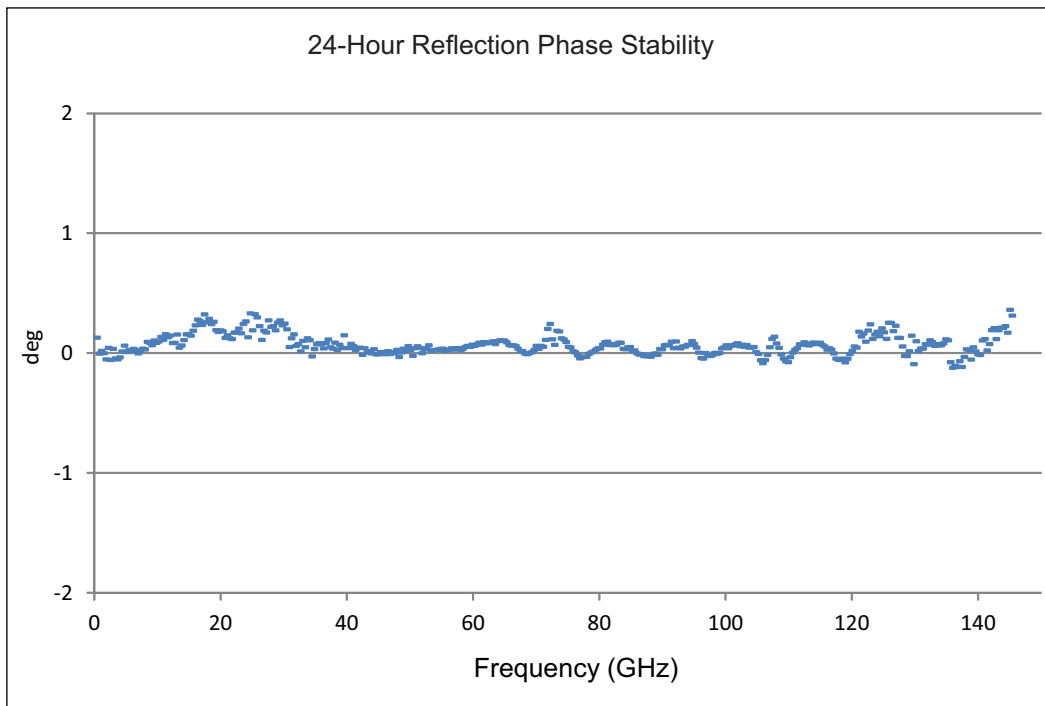

Typical 24-hour reflection phase stability from 70 kHz to 145 GHz in a typical Lab environment when measured at 23 °C ±3°C

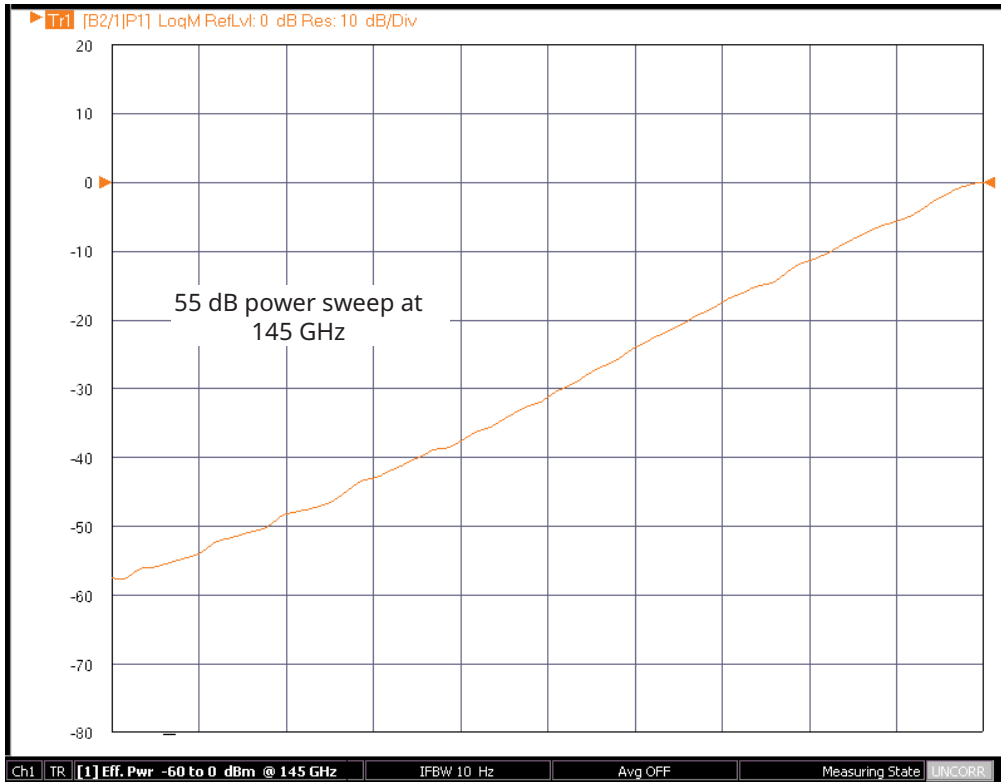

Typical power sweep range at 145 GHz. By using detection and power control inside the MA25300A millimeter-wave module; improved accuracy, linearity and range can be achieved.

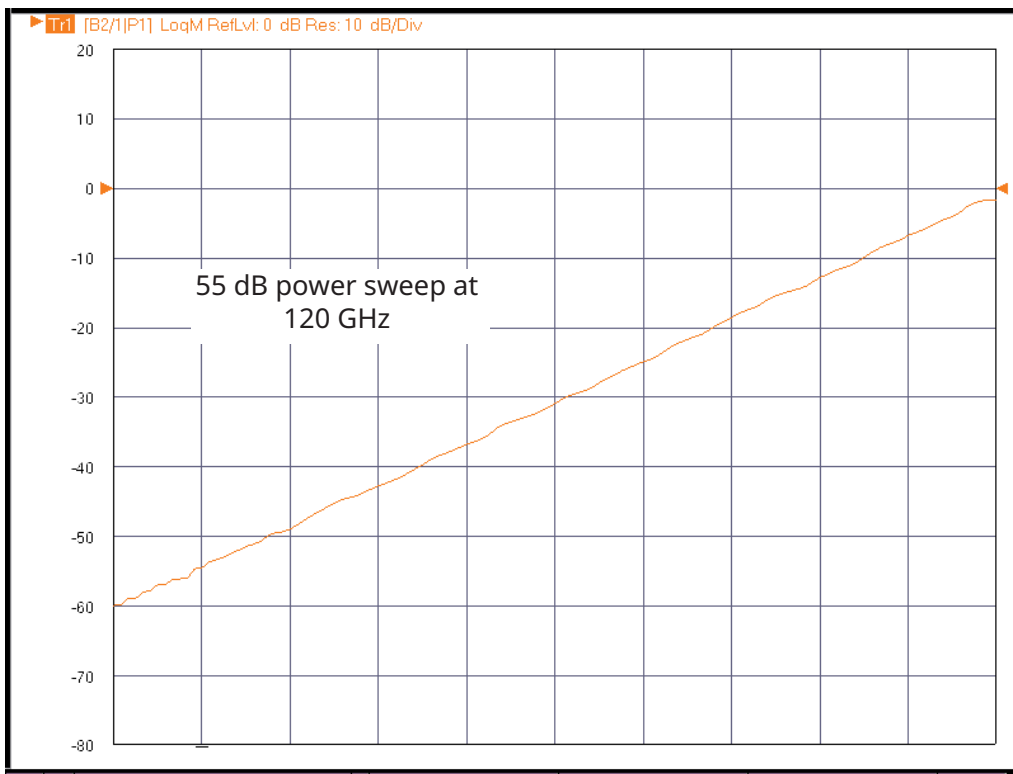

Typical power sweep range at 120 GHz demonstrating greater than 55 dB of control.

Specifications for Waveguide Band Configuration

**ME7838D Millimeter-Wave VNA, Waveguide Bands**

Three configurations are available for waveguide band operation above 145 GHz when using the ME7838D system.

- First, the Anritsu MA25300A Broadband Millimeter-Wave module can be adapted to waveguide measurements using waveguide adapters. Waveguide adapters from Flann are available with 0.8 mm connectors and cover the WR08 and WR06 bands.
- Second, the Anritsu 3744A-EE or 3744A-EW millimeter-wave module can be used. These version modules operate in the extended E and W waveguide bands and are operational using the MS4644B or MS4647B VectorStar (with Options 8x and 7) and the 3739C broadband/millimeter-wave test set.
- The third configuration option is to use external millimeter-wave modules with any model VectorStar (with Options 8x and 7) and the 3739C test set. For millimeter bands, the VDI module may be used.

**E and W Band Operation Using the MA25300A, 3744A-EE, or 3744A-EW mmWave Module**

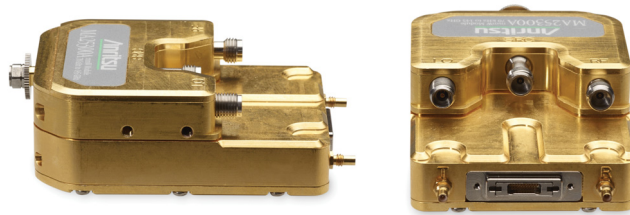

MA25300A Millimeter-Wave Modules



3744A-EE/3744A-EW Millimeter-Wave Module with Waveguide Adapter

The MA25300A Broadband mmWave module can be adapted to a waveguide band output by adding an available waveguide band adapter. Using the MA25300A modules provides the opportunity to sweep frequencies for broadband applications and quickly convert to waveguide configurations for banded measurements. The advantages of small compact modules with excellent RF performance and power range control can therefore be realized in both broadband and waveguide configurations when using the MA25300A mmWave module. For systems where only waveguide band operation is required, for E band or W band modules can be used.

The 3744A-EE or 3744A-EW mmWave module operates from 54 GHz to 110 GHz. The band supported is determined by the waveguide adapter connected to the 1.0 mm test port output of the 3744A-EE/EW module:

- 3744A-EE configures the module for Extended E Band
- 3744A-EW configures for Extended W Band

The RF input port of the 3744A-EE or 3744A-EW module is restricted below 54 GHz, however, the RF input port retains a DC connection to the 1 mm test port. Thus, the waveguide adapter can be removed for on-wafer applications from 54 GHz to 110 GHz operation and the on-wafer DUT can be biased through the RF input port.

Band	Frequency Range (GHz)	Waveguide Flange	Transmission/Reflection Module
Ext-E	56 to 94 <sup>a</sup>	WR-12	3744A-EE
Ext-W	65 to 110	WR-10	3744A-EW

a. Operational to 95 GHz.

**Port Power, Noise Floor, Dynamic Range – 3744A-EE/3744A-EW mmWave Modules**

System dynamic range is defined as the ratio of the source power to the noise floor. Maximum Receiver Power is defined as the 0.2 dB compression point of the receiver at the waveguide port. Receiver dynamic range is defined as the ratio of maximum receive power to the noise floor. Noise Floor measurements are RMS, are made with no average in a 10 Hz IF bandwidth, and include an isolation calibration. All figures are typical.

**3744A-EE Extended-E Band (WR-12) Waveguide**

Frequency Range (GHz)	Source Power (dBm)	Max. Receive Power (0.2 dB comp. pt.) (dBm)	Noise Floor (dBm)	System Dynamic Range (dB)	Receiver Dynamic Range (dB)
56 to 60	-2	11	-111	109	122
> 60 to 65	0	11	-106	106	117
> 65 to 80	-3	11	-109	106	120
> 80 to 85	-4	11	-112	108	123
> 85 to 90	-4	11	-110	106	121
> 90 to 94 <sup>a</sup>	0	12	-105	105	117

a. Operational to 95 GHz.

**3744A-EW Extended-W Band (WR-10) Waveguide**

Frequency Range (GHz)	Source Power (dBm)	Max. Receive Power (0.2 dB comp. pt.) (dBm)	Noise Floor (dBm)	System Dynamic Range (dB)	Receiver Dynamic Range (dB)
65 to 67	0	11	-106	106	117
> 67 to 80	-3	11	-109	106	120
> 80 to 85	-4	11	-112	108	123
> 85 to 90	-4	11	-110	106	121
> 90 to 100	0	12	-105	105	117
> 100 to 110	-5	12	-110	105	122

**Power Range, Accuracy, Linearity, and Resolution**

Accuracy is defined at -10 dBm or max rated power, whichever is lower. Linearity is defined as the incremental error between the accuracy test power level and 5 dB below. Typical.

Frequency (GHz)	Range (dBm)		Accuracy (dB)	Linearity (dB)	Resolution (dB)
	ME7838D	ME7838D Option 62			
54 to 60	-55 to -2	-55 to -2	± 2.0	± 1.5	0.01
> 60 to 65	-55 to 0	-55 to 0	± 2.0	± 1.5	0.01
> 65 to 80	-55 to -3	-55 to -3	± 2.0	± 1.5	0.01
> 80 to 85	-55 to -4	-55 to -4	± 2.0	± 1.5	0.01
> 85 to 90	-55 to -4	-55 to -4	± 2.0	± 1.5	0.01
> 90 to 100	-55 to 0	-55 to 0	± 3.0	± 2.0	0.01
> 100 to 110	-50 to -5	-50 to -5	± 3.0	± 2.0	0.01
> 110 to 120 <sup>a</sup>	-40 to -12	-40 to -12	± 4.0	± 3.0	0.01
> 120 to 125 <sup>a</sup>	-40 to -15	-40 to -15	± 4.0	± 3.0	0.01

a. 110 to 125 GHz frequency range is available as operational.

Alternatively, the V, E, and W bands can be supported using external millimeter-wave modules such as the 3740/41A series modules available from Anritsu. For further description and specifications please refer to the VectorStar ME7828A Technical Data Sheet - 11410-00452 available at [www.anritsu.com](http://www.anritsu.com).

**Corrected System Performance/Uncertainties - 3744A-EE/3744A-EW mmWave Modules**

With 12-term Offset Short Sliding Load or LRL calibrations, using high precision waveguide sections and standards from the appropriate calibration kit.

**3744A-EE Extended-E Band (WR-12) Waveguide - 56 GHz to 94 GHz**

Calibration Type	Directivity (dB)	Source Match (dB)	Load Match (dB)	Reflection Tracking (dB)	Transmission Tracking (dB)
Offset Short	> 44	> 33	> 44	± 0.080	± 0.100
LRL	> 44	> 43	> 44	± 0.006	± 0.006

**3744A-EW Extended-W Band (WR-10) Waveguide - 65 GHz to 110 GHz**

Calibration Type	Directivity (dB)	Source Match (dB)	Load Match (dB)	Reflection Tracking (dB)	Transmission Tracking (dB)
Offset Short	> 40	> 30	> 46	± 0.080	± 0.100
LRL	> 40	> 40	> 46	± 0.006	± 0.006

**Measurement Uncertainties - Extended-E Band - SSLT**

The graphs give measurement uncertainties after the above calibration. The errors are worst case contribution of residual directivity, load and source match, frequency response and isolation, network analyzer dynamic accuracy, and connector repeatability. 10 Hz IF Bandwidth is used. For transmission uncertainties, it is assumed that  $S_{11} = S_{22} = 0$ . For reflection uncertainties, it is assumed that  $S_{21} = S_{12} = 0$ . All calibrations and measurements were performed at default port power. For other conditions, please use our free Exact Uncertainty Calculator software, available for download from the Anritsu web site at [www.anritsu.com](http://www.anritsu.com). Typical.

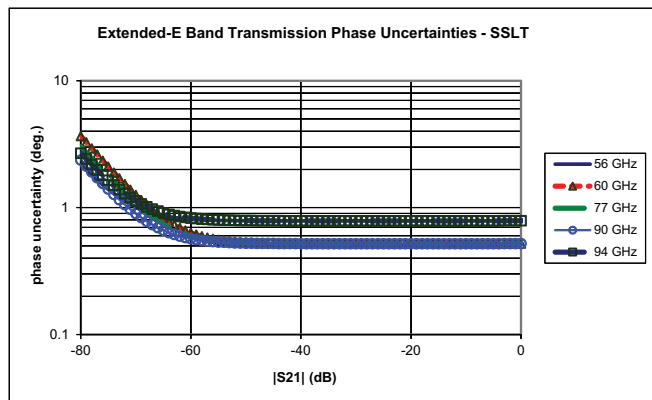
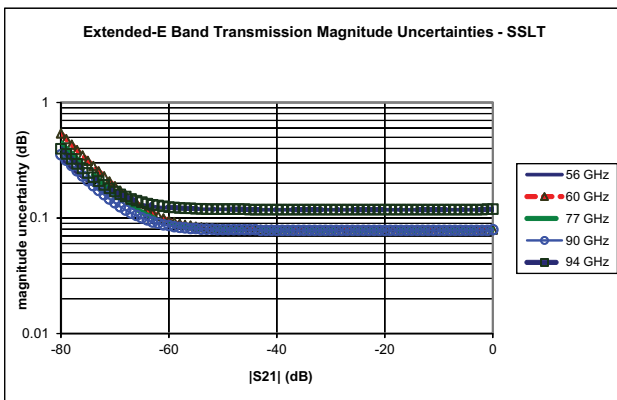
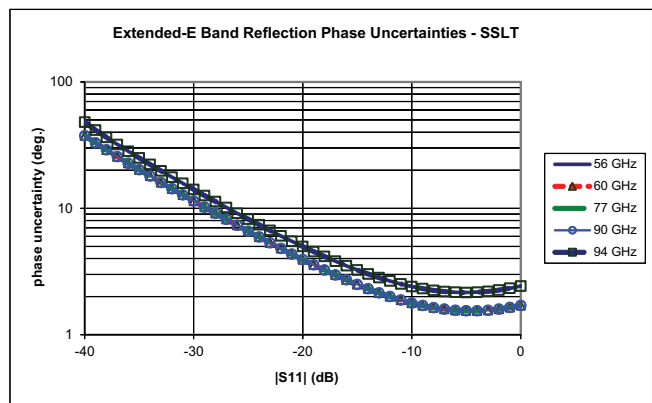
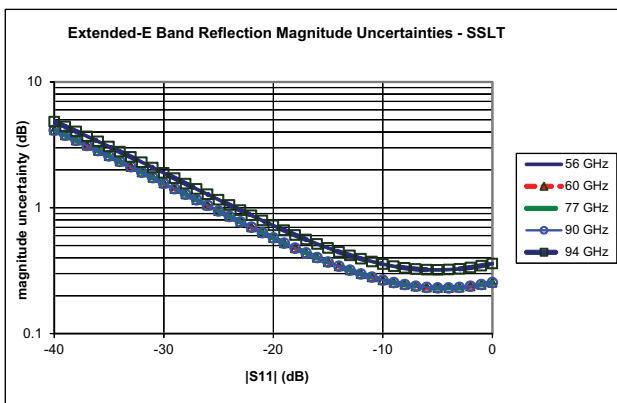

**Measurement Uncertainties – Extended-E Band – LRL**

The graphs give measurement uncertainties after the above calibration. The errors are worst case contribution of residual directivity, load and source match, frequency response and isolation, network analyzer dynamic accuracy, and connector repeatability. 10 Hz IF Bandwidth is used. For transmission uncertainties, it is assumed that  $S_{11}=S_{22}=0$ . For reflection uncertainties, it is assumed that  $S_{21}=S_{12}=0$ . All calibrations and measurements were performed at default port power. For other conditions, please use our free Exact Uncertainty Calculator software, available for download from the Anritsu web site at [www.anritsu.com](http://www.anritsu.com). Typical.

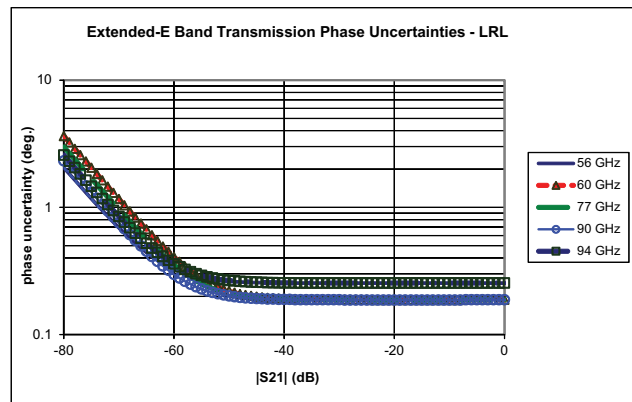
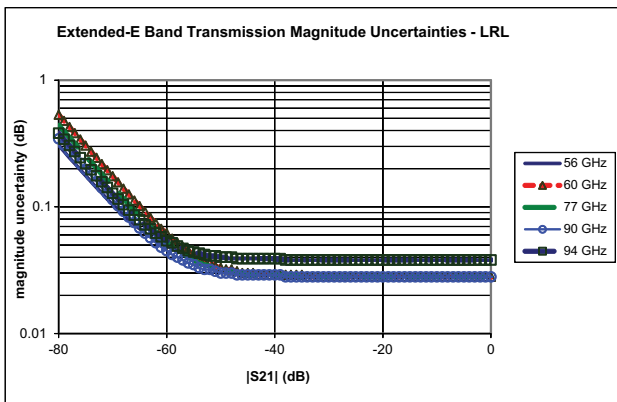
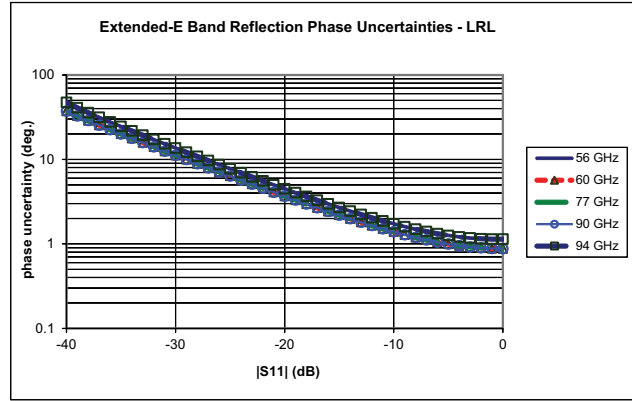
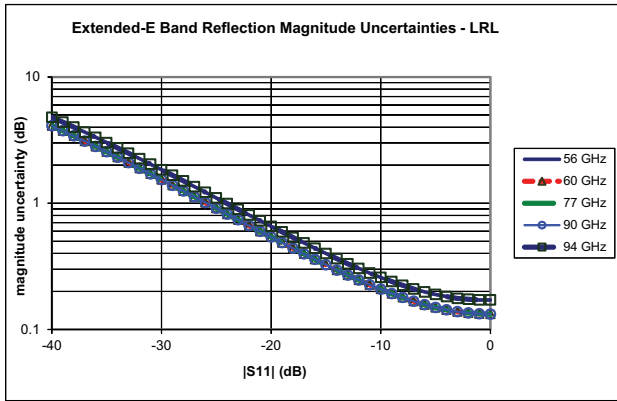

**Measurement Uncertainties – Extended-W Band – SSLT**

The graphs give measurement uncertainties after the above calibration. The errors are worst case contribution of residual directivity, load and source match, frequency response and isolation, network analyzer dynamic accuracy, and connector repeatability. 10 Hz IF Bandwidth is used. For transmission uncertainties, it is assumed that  $S_{11}=S_{22}=0$ . For reflection uncertainties, it is assumed that  $S_{21}=S_{12}=0$ . All calibrations and measurements were performed at default port power. For other conditions, please use our free Exact Uncertainty Calculator software, available for download from the Anritsu website at [www.anritsu.com](http://www.anritsu.com). Typical.

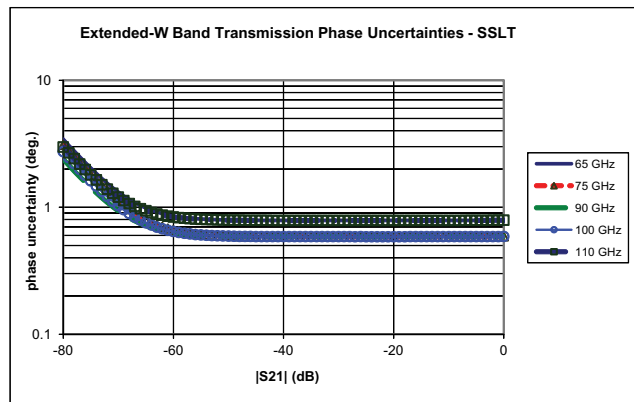
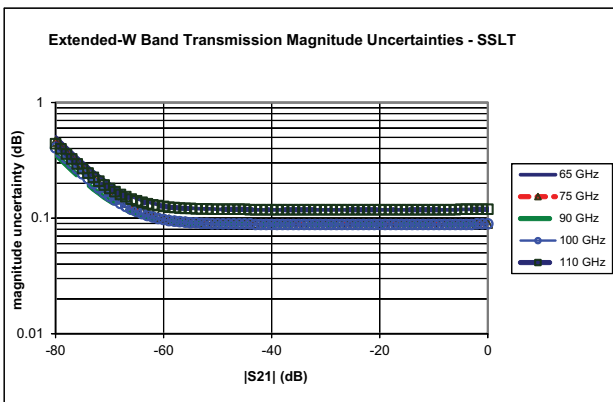
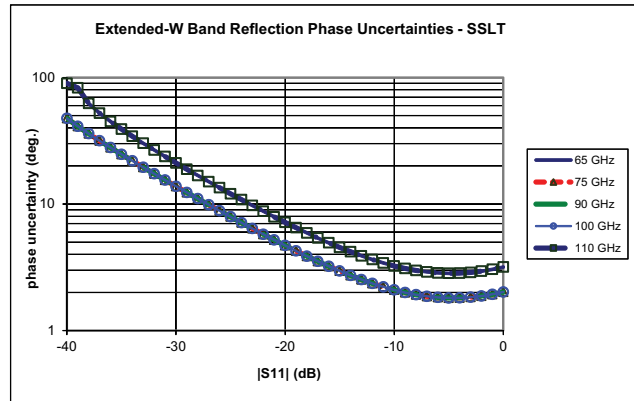
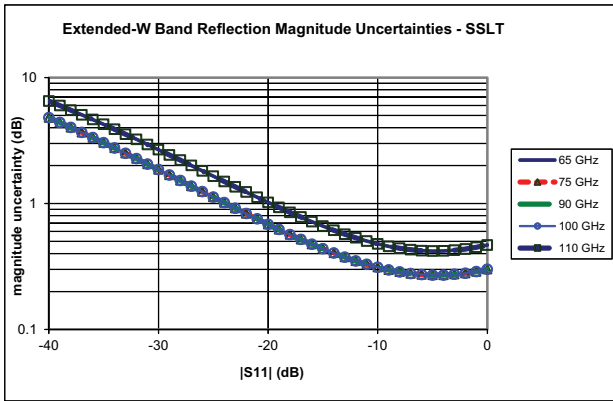

**Measurement Uncertainties – Extended-W Band – LRL**

The graphs give measurement uncertainties after the above calibration. The errors are worst case contribution of residual directivity, load and source match, frequency response and isolation, network analyzer dynamic accuracy, and connector repeatability. 10 Hz IF Bandwidth is used. For transmission uncertainties, it is assumed that  $S_{11} = S_{22} = 0$ . For reflection uncertainties, it is assumed that  $S_{21} = S_{12} = 0$ . All calibrations and measurements were performed at default port power. For other conditions, please use our free Exact Uncertainty Calculator software, available for download from the Anritsu website at [www.anritsu.com](http://www.anritsu.com). Typical.

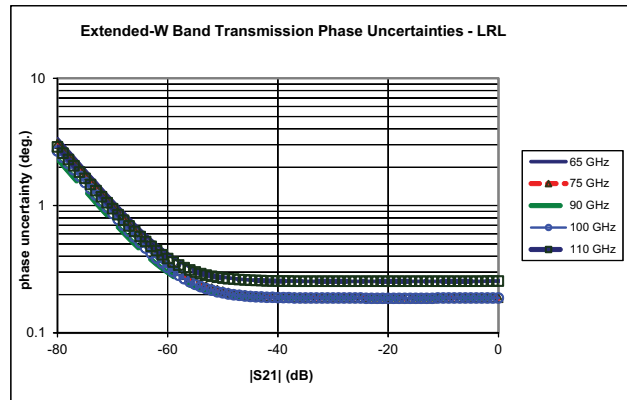
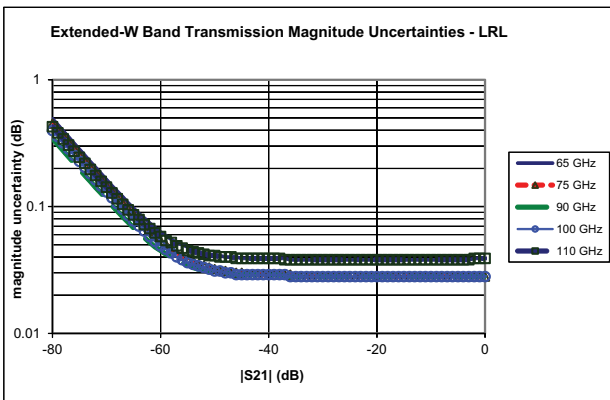
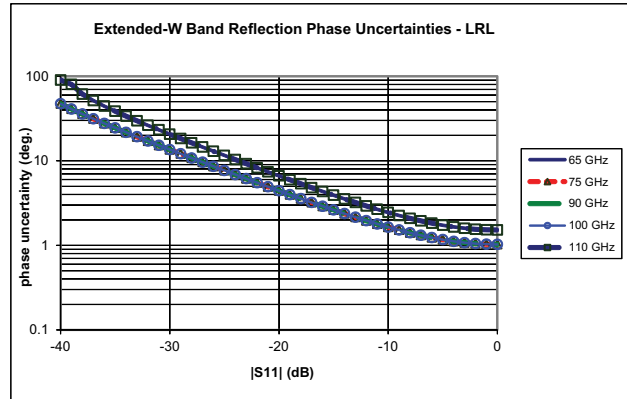
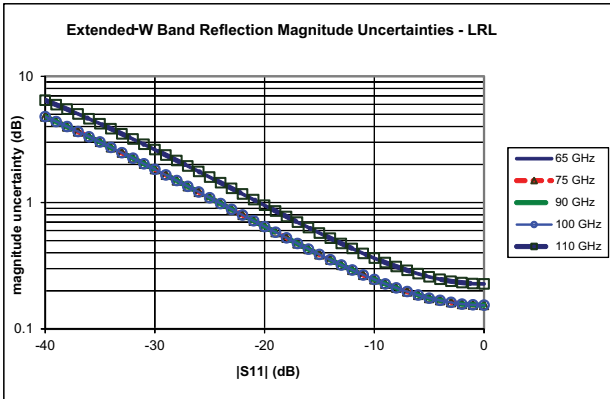

ME7838D with Option 41/48 and 3744A-Rx mmWave Noise Figure Measurements

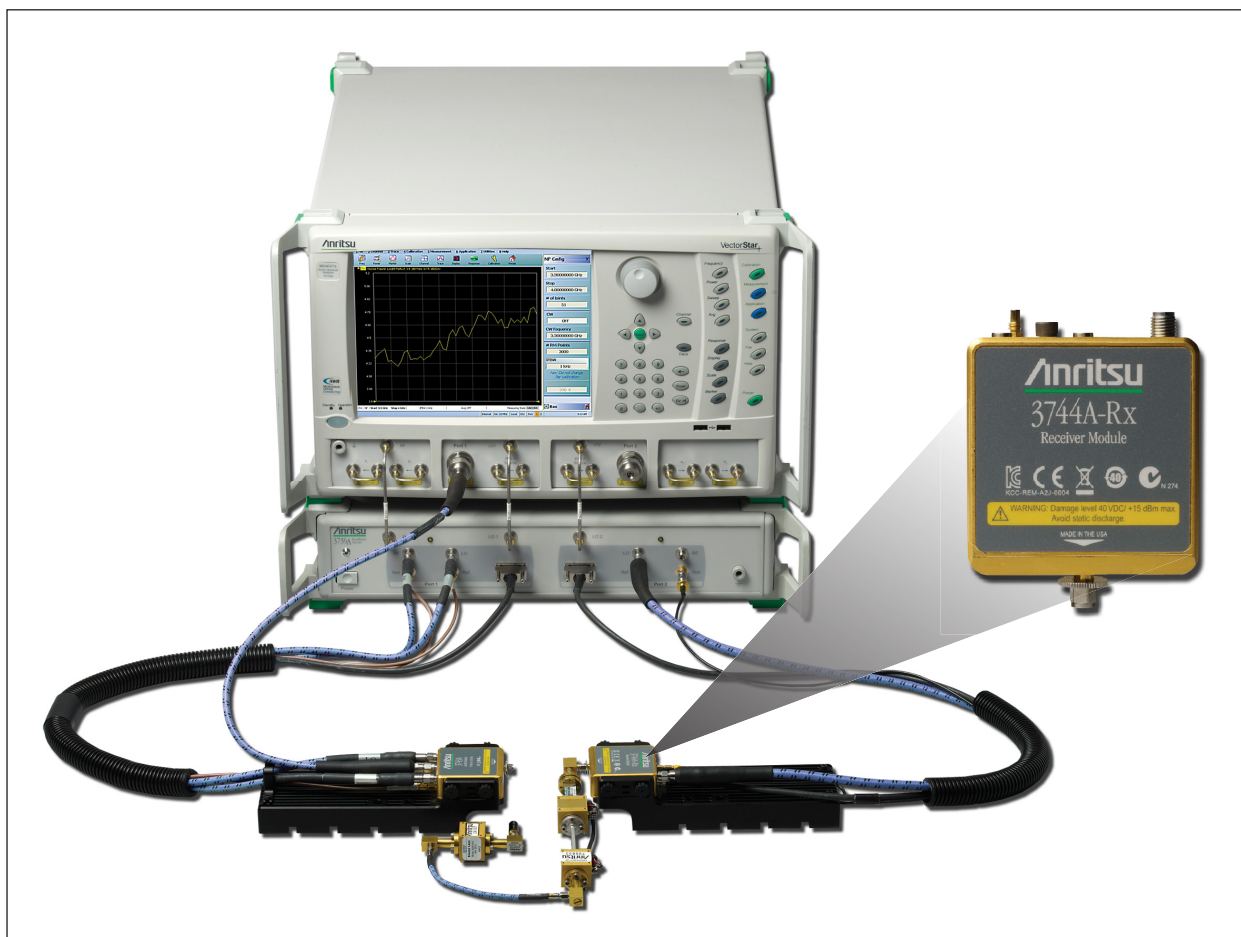

ME7838D with 3744A-Rx Receiver Module

The 3744A-Rx receiver module can be used with Option 41, Noise Figure, and the ME7838D mmWave or broadband system to perform mmWave noise figure measurements from 30 GHz to 125 GHz. The receiver bypasses the internal couplers (see block diagram), maximizing the noise figure of the receiver for optimum noise figure measurement accuracy. The receiver is derived from the 3743A mmWave module and utilizes the same nonlinear transmission line technology for optimum mmWave performance. Using the advantages of the 3743A mmWave module system architecture provides a unique solution to mmWave noise figure measurements previously unavailable.

With Option 48, differential (and common-mode) noise figure measurements are possible in the same wide frequency ranges. In this case, two 3744A-Rx modules (along with needed pre-amplifiers/filters) are used to complete the differential receiver. While usually a 4-port system is used, a 2-port ME7838D can be used for the noise measurements as long as DUT gain information is available.

**Block Diagram – 3744A Receiver Module**

The 3744A-Rx receiver module is optimized as a receiver-only mmWave module for applications such as mmWave antenna measurements and mmWave noise figure measurements. Elimination of the input coupler produces a mmWave receiver with excellent noise floor sensitivity and dynamic range. When coupled with a composite receiver, the receiver module provides a solution for mmWave noise figure measurements.

As with all cold source method noise figure measurements, the output of the DUT is first sent to an external composite receiver for pre-amplification. This ensures that the system noise figure is minimized for optimum measurement accuracy. The Anritsu Noise Figure Uncertainty Calculator (available on the website at [www.anritsu.com](http://www.anritsu.com)) can be used to determine optimum preamplifier gain needed for the desired measurement uncertainty.

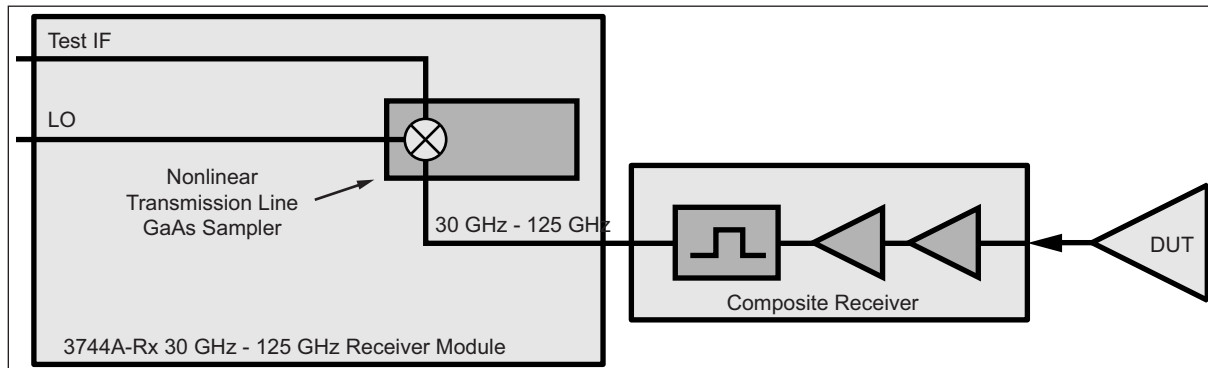

3744A-Rx Block Diagram configured for mmWave noise figure measurements

(Two composite receivers and two 3744A-Rx modules are used with Option 48 for differential or common-mode noise figure measurements.)

**3744A-Rx Receiver Compression, Noise Floor**

Receiver Compression Point is defined as the port power level beyond which the response may be compressed more than 0.2 dB relative to the normalization level. 10 Hz IF bandwidth is used to remove trace noise effects. All typical.

Noise Floor is relative to the receiver power calibration performed at -10 dBm. Typical.

Frequency (GHz)	Receiver Compression (dBm) <sup>a</sup>	Noise Floor (dBm) <sup>b</sup>
30 to 54	0	-124
> 54 to 60	0	-122
> 60 to 67	0	-117
> 67 to 80	0	-120
> 80 to 85	0	-123
> 85 to 90	0	-121
> 90 to 95	0	-121
> 95 to 105	0	-117
> 105 to 110	0	-122
> 110 to 120	-5	-120
> 120 to 125	-5	-117

a. At the 3744A-Rx test port.

b. Excludes localized spurious responses and crosstalk.

**VectorStar ME7838D Waveguide Bands from 50 GHz to 1.1 THz**

The VectorStar Millimeter-Wave system supports VDI modules starting at 50 GHz. System performance is based on the specific mmWave module installed and appropriate cal kit. The mmWave modules need to provide IF levels of -15 dBm to -5 dBm when the RF drive is set to maximum in order to deliver specified dynamic range. Contact the vendor web site for additional information.



VDI Millimeter-Wave Module

**Block Diagram – Millimeter-Wave VNA System**

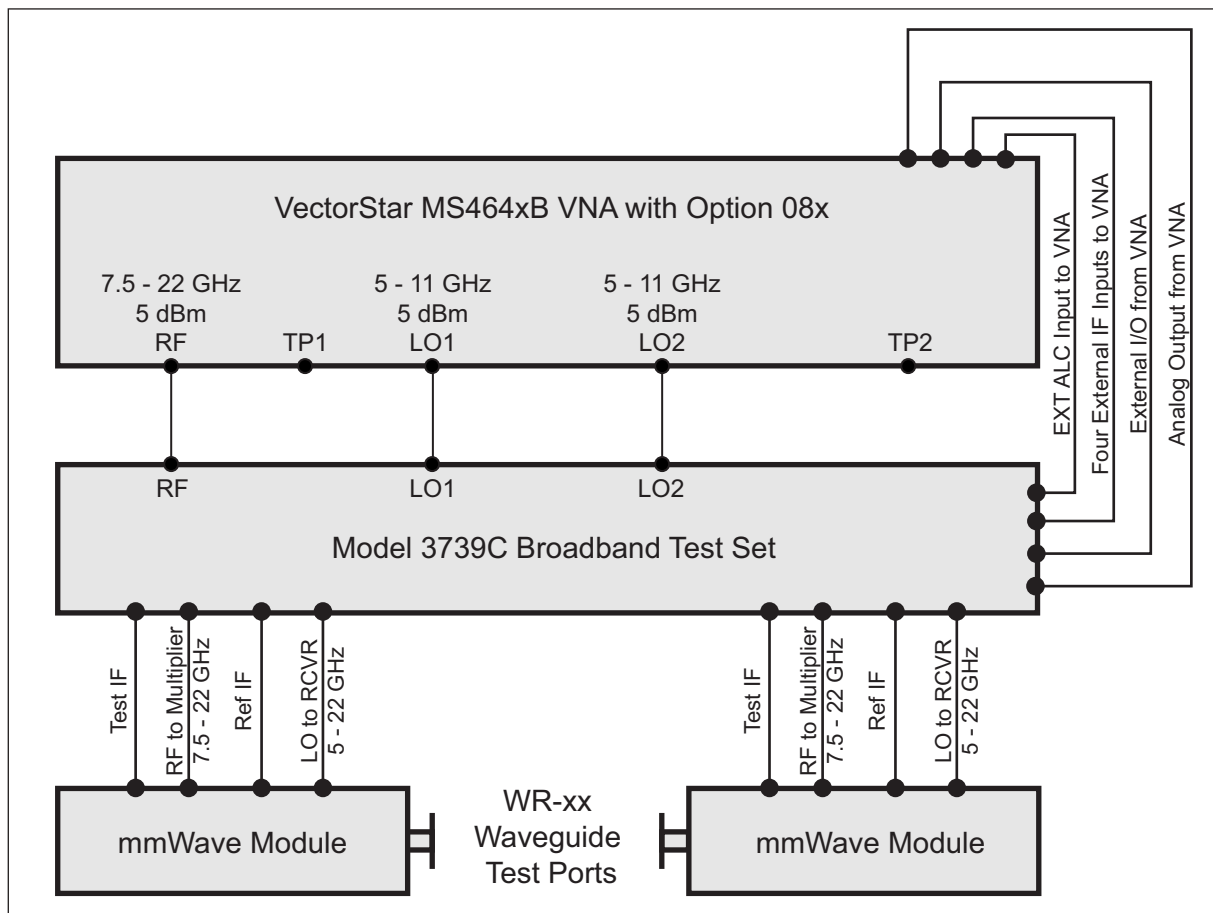

Millimeter-Wave Configuration Block Diagram

**VectorStar ME7838D Millimeter-Wave System with VDI Modules**

This section provides the specifications for the VectorStar MS4640B series microwave Vector Network Analyzers (VNAs) when configured with the Virginia Diodes, Inc. millimeter-wave (mmWave) frequency extension modules. The following frequency bands are supported:

Waveguide Band	WR15	WR10	WR8.0	WR6.5	WR5.1	WR4.3	WR3.4	WR2.8	WR2.2	WR1.5	WR1.0 <sup>a</sup>
Frequency (GHz)	50 to 75	75 to 110	90 to 140	110 to 170	140 to 220	170 to 260	220 to 330	260 to 400	330 to 500	500 to 750	750 to 1100

a. Contact Anritsu

**System Configuration with VDI Modules**

The VectorStar Millimeter-Wave system provides control of VDI modules for frequency extension coverage up to 1.1 THz\*. MS4640B series VectorStar VNA may be configured for mmWave operation by adding the appropriate control option and test set. System requirements include:

- VectorStar VNA Model MS4642B, MS4644B, or MS4647B  
(Note: For 1.1 THz operation, the 40 GHz MS4644B or higher model is required.)
  - Options MS4640B Option 7, Receiver Offset  
MS4640B Option 80-85
  - Test Set 3739C Test Set
  - Cable SM6537 Interface Cable – Connection between VectorStar and the VDI mmWave module is provided with this interface cable.
- Each VDI module is equipped with a dedicated external power supply and DC cable.

**VDI Module Performance with VectorStar**

- Performance: Directivity values are valid when using appropriate VDI calibration kits. All extender heads include a precision Test Port. The performance values here are typical and subject to change. Extended and other frequency ranges may be available.
- Stability: Measured for 1 hour after a 1 hour system warm-up, in a stable environment with ideal cables.
- Dynamic Range: The dynamic range (RBW 10 Hz) is measured by first connecting two TxRx heads together and normalizing the uncalibrated S21 and S12. The heads are then disconnected and terminated with a waveguide short. The rms of the measured S21 & S12 give the system dynamic range.
- Test Port Power: Test Port Power is typical. Reduced power is possible at band edges.

**VDI Extenders-Summary of Specifications (Typical)**

Waveguide Band	WR15	WR12	WR10	WR8.0	WR6.5	WR5.1	WR4.3	WR3.4	WR2.8	WR2.2	WR1.5 <sup>a</sup>	WR1.0 <sup>a</sup>
Frequency Coverage [GHz]	50-75	60-90	75-110	90-140	110-170	140-220	170-260	220-330	260-400	330-500	500-750	750-1100
Dynamic Range BW = 10 Hz, [dB], (Typical)	120	120	120	120	120	120	115	115	100	110	100	65
Magnitude Stability [± dB]	0.1	0.1	0.1	0.15	0.25	0.25	0.3	0.3	0.5	0.5	0.4	0.5
Phase Stability [± deg.]	1.5	1.5	1.5	2	4	4	4	6	6	6	4	6
Test Port Power [dBm], (Typical)	13	18	18	16	13	6	4	1	-10	-3	-25	-30
Test Port Input Limit <sup>b</sup> [dBm, Saturation/Damage]	30	30	30	30	30	30	28	26	16	10	-3	-3
Directivity [dB]	30	30	30	30	30	30	30	30	30	30	30	30

a. Mini versions of these modules are available with higher port power and dynamic range.

b. Test Port Input Limits are shown for standard test port power models only.

**VDI Module Head Configurations**

- TxRx Transmitter with two receivers (reference and measurement), and two couplers. Two TxRx heads are required for full two-port measurements.
- TxRef Transmitter with reference receiver and one coupler.
- Rx Measurement receiver.
- Tx Transmitter.

**VDI Module Options**

- Micrometer-Drive Variable Attenuator A 0 dB to 30 dB micrometer-drive variable attenuator option is available on TxRx and Tx modules up through WR1.5. If ordered, "-Attn" is added as an option suffix to the module model number. The attenuators reduce TPP and DR by as much as 8 dB in the WR3.4 and higher frequency bands and add approximately 2 in to the enclosure.
- Increased Test Port Power Options exist for increasing test port power in some full bands or in partial bands. Consult factory for more information.
- Non-Standard Frequency Bands Non-standard frequency bands or other specific needs are possible. Consult factory for more information.
- Custom Configuration Anritsu/VDI will work with customers to reconfigure any extender to meet specific needs.

ME7838D Measurement Examples Using VDI Millimeter-Wave Modules

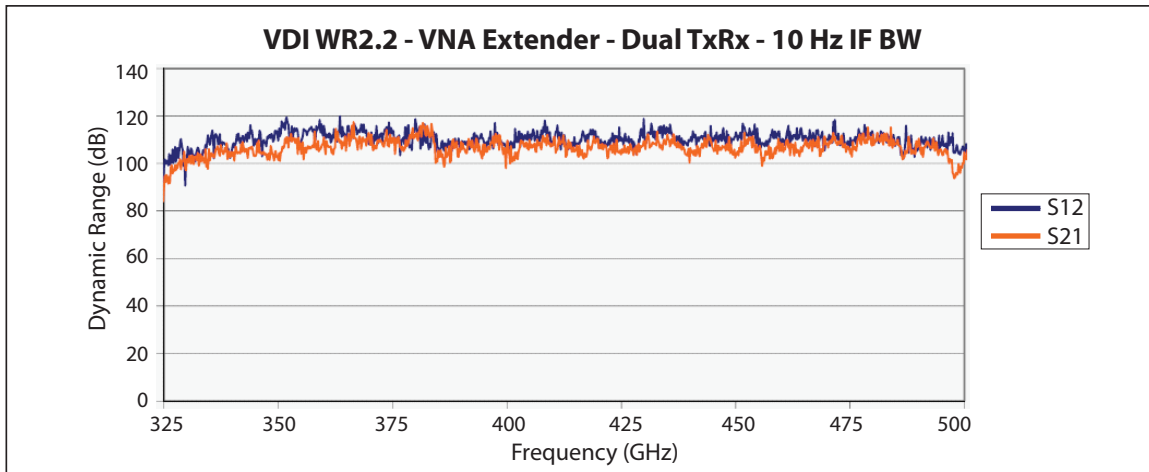

Typical Dynamic Range Plot of VDI WR2.2 Module - 10 Hz IFBW

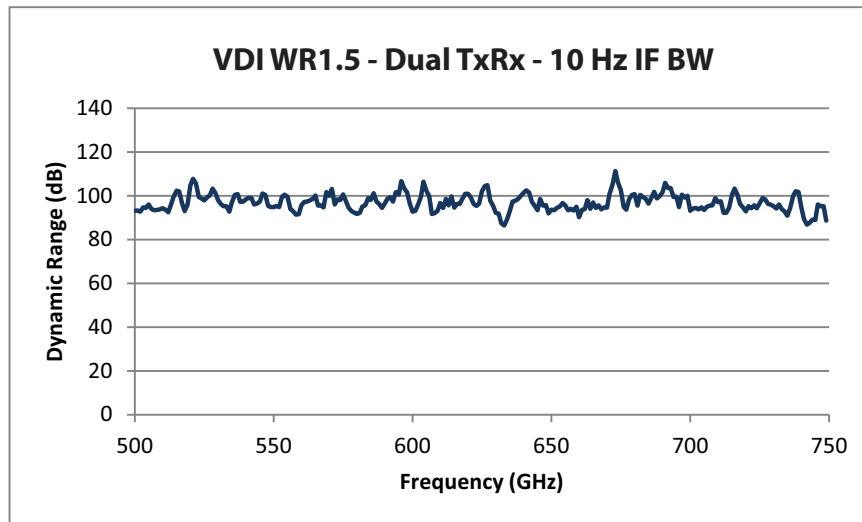

Typical Dynamic Range Plot of VDI WR1.5 Dual TxRx - 10 Hz IFBW

ME7838D 400 GHz Power Sweep with VDI WR2.2 TxRx Module

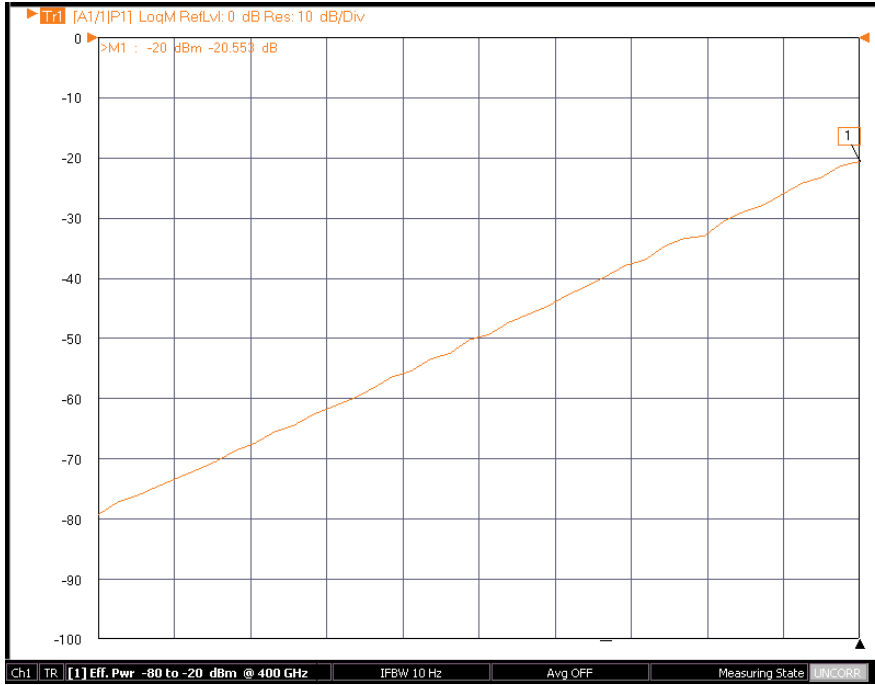

Typical real-time power sweep of VDI WR2.2 module using system power level control and no mechanical attenuators.

**Standard Capabilities for All Configurations**

For standard capabilities of the VectorStar VNAs, please see the **VectorStar MS4640B Series VNA Technical Data Sheet and Configuration Guide - 11410-00611**, available at [www.anritsu.com](http://www.anritsu.com).

**Mechanical and Environmental**

**MS4640B Vector Network Analyzer** Dimensions without rack mount option.

Height	267 mm body (6u) 286 mm between feet outer edges
Width	426 mm body 457 mm between feet outer edges 487 mm between front panel handles outer edges
Depth	502 mm body 591 mm between handle and foot outer edges
Weight	< 28 kg (< 62 lbs) Typical weight for a fully-loaded MS4647B VNA

**3739C Broadband/Millimeter-Wave Test Set** Dimensions without rack mount option.

Height	89 mm body (2u) 108 mm between feet outer edges
Width	426 mm body 457 mm between feet outer edges 487 mm between front panel handles outer edges
Depth	502 mm body 591 mm between handle and foot outer edges
Weight	5.75 kg (12.7 lbs)

**MA25300A Millimeter-Wave Module**

Height	26.6 mm
Width	54 mm
Depth	72.4 mm
Weight	0.22 kg

**Environmental – Operating**

Temperature Range	Conforms to MIL-PRF-28800F (Class 3) 0 °C to +50 °C without error codes* * Except for 'unleveled' error messages that may occur at the extreme edges of the temperature range above.
Relative Humidity	5 % to 95 % at +30 °C, Non-condensing
Altitude	4,600 m (15,000 ft)

**Environmental – Non-Operating**

Temperature Range	-40 °C to +71 °C
Relative Humidity	0 % to 90 % at +30 °C, Non-condensing
Altitude	4,600 m (15,000 ft)

**Regulatory Compliance**

European Union	EMC 2014/30/EU, EN 61326:2013, CISPR 11/EN 55011, IEC/EN 61000-4-2/3/4/5/6/8/11 Low Voltage Directive 2014/35/EU Safety EN 61010-1:2010 RoHS Directive 2011/65/EU & Amendment 2015/863
United Kingdom	EMC SI 2016/1091; BS EN 55011 & BS EN 61000-4-2/3/4/5/6/8/11 Consumer Protection (Safety) SI 2016/1101; BS EN 61010-1:2010 Environmental Protection SI 2012/3032; 2011/65/EU & 2015/863
Canada	ICES-1(A)/NMB-1(A)
Australia and New Zealand	RCM AS/NZS 4417:2012

**Warranty**

The ME7838D Series VNAs and related accessories offer a 1-year warranty from the date of shipment (excluding VDI modules). Please contact your local service center for additional warranty coverage.

## Calibration and Correction Capabilities

<b>Calibration Methods</b>	<p>Short-Open-Load-Through (SOLT) with Fixed or Sliding Load and supporting .s1p-defined cal kits</p> <p>Offset-Short-Offset-Short-Load-Through (SSLT) with Fixed or Sliding Load</p> <p>Triple-Offset-Short-Through (SSST) and overdetermined multiple offset short (mSSST)</p> <p>Short-Open-Load-Reciprocal (SOLR) or Unknown Through Method (SSLR, SSSR)</p> <p>Line-Reflect-Line (LRL) / Line-Reflect-Match (LRM) – (up to 5 bands supported for multi-line configurations)</p> <p>Thru-Reflect-Line (TRL) - (up to 5 bands supported)</p> <p>Advanced-LRM (A-LRM™) for improved on-wafer calibrations</p> <p>mTRL (Multiline TRL)</p> <p>Hybrid cals (allows combination of sub-cals of different type or media)</p> <p>AutoCal™</p> <p>Thru Update available</p> <p>Secondary match correction available for improved low insertion loss measurements</p>
<b>Correction Models</b>	<p>2-Port (Forward, Reverse, or both directions)</p> <p>1-Port (<math>S_{11}</math>, <math>S_{22}</math>, or both)</p> <p>Transmission Frequency Response (Forward, Reverse, or both directions)</p> <p>Reflection Frequency Response (<math>S_{11}</math>, <math>S_{22}</math>, or both)</p>
<b>Merged Calibration</b>	<p>Merge multiple calibration methods over bands of frequency points.</p> <p>Note that merge does not need to be used for broadband coaxial (SOLT/R-SSST/R) 1 mm or 0.8 mm calibrations using Anritsu calibration kits. These can be done as one unified calibration.</p>
<b>Coefficients for Calibration Standards</b>	<p>Use the Anritsu calibration kit USB Memory Device to load kit coefficients and characterization files.</p> <p>Enter manual coefficients into user-defined locations.</p> <p>Use complex load models.</p>
<b>Reference Impedance</b>	<p>Modify the reference impedance from 50 <math>\Omega</math> to any impedance greater than 0 <math>\Omega</math>.</p>
<b>Interpolation</b>	<p>Allows interpolation between calibration frequency points. Accuracy will be reduced at non-calibration frequencies and that degradation is dependent on the frequency step size in the initial calibration and the electrical length of the user's setup.</p>
<b>Adapter Removal Calibration</b>	<p>Characterizes and “removes” an adapter that is used during calibration that will not be used for subsequent device measurements; for accurate measurement of non-insertable devices.</p>
<b>Dispersion Compensation</b>	<p>Selectable as Coaxial, other non-dispersive (e.g., for coplanar waveguide), Waveguide, or Microstrip.</p>
<b>Power</b>	
Power Meter Correction	<p>Different power meter calibrations are available to enhance power accuracy at the desired reference plane. The source power will match the target calibration power, as read by the power meter, to within <math>\sim 0.1</math> dB for short periods of time (determined by thermal drift of the system and the power meter). The absolute accuracy of the calibrated power will be dependent on the power meter and sensor used.</p>
Flat Power Calibrations	<p>A flat power calibration (when in frequency sweep mode) is available at a user-selectable power level, if it is within the power adjustment range of the internal source. The flat power correction is applied to other power levels directly as an offset. Multiple power meters/sensors may be needed depending on the frequency range. An adapter may be required to the 1mm module test port.</p>
Linear Power Calibrations	<p>A linear power calibration is performed over a range of power levels for use in power sweep mode and is performed at a specified frequency or frequency range (for multifrequency gain compression).</p>
External Power Meter	<p>Both calibrations are performed using an external power meter (Anritsu ML2438A, ML248xB, ML249xA, Agilent 437B (or equivalent), Keysight N191XA/EPM Series, Rhode and Schwarz NRP2 meter with a broadband 110 GHz sensor, or Elva DPM power meter) over the Dedicated GPIB port, or a USB power sensor (Anritsu MA24106A, MA24108A, MA24118A, MA24126A, MA24208A, MA24218A, MA24330A, MA24340A, MA24350A, MA24507A, or MA24510A, or Erickson PM5x meter) connected to a USB port.</p> <p>Note: Usage of the MA24500A series sensor requires a dual USB Type A male to single USB Type A female cable to supply needed current draw. Because of certain bandwidth requirements, the MA24500A series can only be used for power calibrations above nominally <math>-35</math> dBm on VectorStar. Accuracy with the MA24500A series of sensors (when used with VectorStar) may be degraded below 1 MHz.</p>
<b>Embedding/De-embedding</b>	<p>The MS4640B is equipped with an Embedding/De-embedding system.</p>
De-embedding	<p>De-embedding is generally used for removal of test fixture contributions, modeled networks and other networks described by S-parameters (s2p files) from measurements.</p>
Embedding	<p>Similarly, the Embedding function can be used to simulate matching circuits for optimizing amplifier designs or simply adding effects of a known structure to a measurement.</p>
Multiple Networks	<p>Multiple networks can be embedded/de-embedded and changing the port and network orientations is handled easily.</p>
Extraction Utility	<p>An extraction utility is part of this package that allows the easier computation of de-embedding files based on some additional calibration steps and measurements.</p>
<b>Impedance Conversion</b>	<p>Allows entry of different impedances (complex values) for different ports.</p>

Mechanical Calibration/Verification Kits

**0.8 mm Calibration/Verification Kit, 3659**

Provides 12-term SOLT or Triple Offset Short calibrations, for 0.8 mm devices, and two verification standards.



3659 0.8 mm Calibration/Verification Kit providing 12-Term SOLT or SSST calibrations and two verification standards.

3659 Cal Kit Contains:	Additional Information (Typical)	Quantity	Part Number
0.8 mm Calibration / Verification Kit			3659
Offset Short 0.8 mm (male)	Offset: 1.200 mm	1	23.850-1
Offset Short 0.8 mm (male)	Offset: 1.630 mm	1	23.850-2
Offset Short 0.8 mm (male)	Offset: 2.060 mm	1	23.850-3
Offset Short 0.8 mm (female)	Offset: 1.200 mm	1	23.8F50-1
Offset Short 0.8 mm (female)	Offset: 1.630 mm	1	23.8F50-2
Offset Short 0.8 mm (female)	Offset: 2.060 mm	1	23.8F50-3
Open 0.8 mm (male)	Offset: 1.200 mm	1	24.850
Open 0.8 mm (female)	Offset: 1.200 mm	1	24.8F50
Fixed Termination 0.8 mm (male)		1	28.850
Fixed Termination 0.8 mm (female)		1	28.8F50
Adapter, 1.0 mm (male) to 0.8 mm (male) Connector		1	33W.850
Adapter, 1.0 mm (male) to 0.8 mm (female) Connector		1	33W.8F50
Adapter, 1.0 mm (female) to 0.8 mm (male) Connector		1	33WF.850
Adapter, 1.0 mm (female) to 0.8 mm (female) Connector		1	33WF.8F50
Adapter, 0.8 mm (male) to 0.8 mm (female)		1	33.8.8F50
Adapter, 0.8 mm (male) to 0.8 mm (male)		1	33.8.850
Adapter, 0.8 mm (female) to 0.8 mm (female)		1	33.8F.8F50
Stepped Impedance ThruLine, 0.8 mm (male - female)	Verification Device	1	18.8.8F50-1B
50 Ohm matched ThruLine, 0.8 mm (male - female)	Verification Device	1	18.8.8F50-1
Torque Wrench	6 mm, 5.4 N-cm (4 lbf-in)	1	01-524
Open-ended Wrench	6 mm / 7 mm	1	01-525
Coefficients for standards	On USB Memory Device	1	-

**Test Port Cables**

**Test Port Cables, Flexible, High Performance**

Description	Frequency Range	Impedance	Length (cm)	Insertion Loss (dB)	Return Loss (dB)	Part Number
1.0 mm (male) 1.0 mm (female)	DC to 110 GHz (125 GHz)	50 Ω	10	1.74	≥ 14	3671W1-50-1
			13	2.23	≥ 14	3671W1-50-2
			16	2.74	≥ 14	3671W1-50-3
0.8 mm (male) 0.8 mm (female)	DC to 145 GHz	50 Ω	10	2	≥ 12	3670.850-1
0.8 mm (male) 0.8 mm (female)	DC to 145 GHz	50 Ω	16	3.5	≥ 12	3670.850-2



3670.850-1, 3670.850-2, 0.8 mm Test Port Cables

**Precision Adapters, Attenuators, and Other Components**

Anritsu offers a complete line of precision adapters and attenuators. For more information, please visit our web site at [www.anritsu.com](http://www.anritsu.com).



**Ordering Information**

The ME7838D Broadband/Millimeter-Wave VNA System provides single sweep coverage from 70 kHz to 145 GHz and consists of the following standard components and optional accessories described in the sections below:

<b>ME7838D Broadband System, 70 kHz to 145 GHz</b>		
<b>Action</b>	<b>Part Number and Description</b>	<b>Additional Information</b>
Order the base VectorStar model with the listed options:	MS4647B, 70 kHz to 70 GHz VNA MS4640B-007, Receiver Offset MS4640B-070, 70 kHz frequency coverage 3739C, Broadband Test Set with 36 inch interface cables MA25300A, Millimeter-Wave Module, 2 each ME7838D-SS020, On-site system assembly and verification	
Include one of the following:	MS4647B-080, MS4647B with ME7838D system option	MS4647B-084 is ordered when Option 31 is included.
	MS4647B-081, MS4647B with ME7838D system option and Option 51 or 61 or 62	MS4647B-085 is ordered when Option 31 is included.
Include one of the following:	806-206-R, 1.85 mm coaxial VNA RF cables, 24", M-F, 2 each	
	806-209-R, 1.85 mm coaxial VNA RF cables, 36", M-F, 2 each	
Add options if desired:	Option 51, or 61, or 62: MS4647B-051 – External VNA Loops MS4647B-061 – Active Measurement Suite, 2 Attenuators MS4647B-062 – Active Measurement Suite, 4 Attenuators	
	MS4640B-002 – for Time Domain MS4647B-031 – Dual Source Architecture MS4640B-035 – IF Digitizer MS4640B-041 – Noise Figure MS4640B-042 – PulseView™ MS4640B-043 – DifferentialView™ MS4640B-048 – Differential Noise Figure MS4640B-049 – Spectrum Analysis	MS4647B-031 requires Option 84 or 85.  For other available options, see <a href="#">“ME7838D Broadband/Millimeter-Wave System Options”</a>
Calibration Options	ME7838D-098 - Standard Calibration, ISO 17025 compliant, without data ME7838D-099 - Premium Calibration, ISO 17025 compliant, with data	
Accessories	MS4640B-001, MS4640B rack mount 3739C-001, 3739C rack mount	

**Broadband/Banded/Millimeter-Wave Extensions — Option 8x**

- Option 80 Broadband/Millimeter-Wave. For broadband systems with a single-source VNA and without loop options (51, 61 or 62)
- Option 81 Broadband/Millimeter-Wave. For broadband systems with a single-source VNA and with a loop option.
- Option 82 Banded Millimeter-Wave Extension. For banded systems with a single-source VNA and without loop options (51, 61 or 62)
- Option 83 Millimeter-Wave Extension. For banded systems with a single-source VNA and with a loop option.
- Option 84 Broadband/Banded/Millimeter-Wave Extension. For systems with a dual-source VNA and without loop options (51, 61 or 62)
- Option 85 Broadband/Banded/Millimeter-Wave Extension. For systems with a dual-source VNA and with a loop option.
- Option 86 Broadband/Millimeter-Wave. For 110 GHz-limited broadband systems with a single-source VNA and without loop options (51,61 or 62)
- Option 87 Broadband/Millimeter-Wave. For 110 GHz-limited broadband systems with a single-source VNA and with a loop option.
- Option 88 Broadband/Banded/Millimeter-Wave Extension. For 110 GHz-limited broadband systems with a dual-source VNA and without loop options (51, 61 or 62)
- Option 89 Broadband/Banded/Millimeter-Wave Extension. For 110 GHz-limited broadband systems with a dual-source VNAs and with a loop option.

**ME7838D Waveguide-Band System to 110 GHz – 3744A-EE or 3744A-EW mmWave Modules**

Configurator for ME7838D Millimeter-Wave System using 3744A-EE or 3744A-EW mmWave Modules:

Action	Part Number and Description	Additional Information
Choose and order one of the two base VectorStar models with options listed:	MS4644B VNA, 10 MHz to 40 GHz MS4640B-007, Receiver Offset MS4644B-082 or -083 or -084 or -085	MS4644B-083 is ordered when Options 51, 61, or 62 are included. MS4644B-084 is ordered when Option 31 is included and Options 51, 61, or 62 are <i>excluded</i> . MS4644B-085 is ordered when Option 31 <i>and</i> Options 51, 61, or 62 are <i>included</i> .
	MS4647B VNA, 10 MHz to 70 GHz MS4640B-007, Receiver Offset MS4647B-080 or -081 or -084 or -085	MS4647B-081 is ordered when Options 51, 61, or 62 are included MS4647B-084 is ordered when Option 31 is included and Options 51, 61, or 62 are <i>excluded</i> . MS4647B-085 is ordered when Option 31 <i>and</i> Options 51, 61, or 62 are included. MS4647B-085 is ordered when Option 31 is included.
Order Test Set	3739C mmWave Test Set	
Choose and order Extended-E or Extended-W Band Modules:	3744A-EE, 56 GHz to 94 GHz Extended E Band module, 2 each	
	3744A-EW, 65 GHz to 110 GHz Extended W Band module, 2 each	
Add options if desired:	Option 51, or 61, or 62: MS464xB-051 – External VNA Loops MS464xB-061 – Active Measurement Suite, 2 Attenuators MS464xB-062 – Active Measurement Suite, 4 Attenuators	
	MS4640B-070 – for 70 kHz operation in base VNA MS4640B-002 – for Time Domain MS464xB-031 – Dual Source Architecture MS4640B-035 – IF Digitizer MS4640B-041 – Noise Figure MS4640B-042 – PulseView™ MS4640B-043 – DifferentialView™ MS4640B-048 – Differential Noise Figure MS4640B-049 – Spectrum Analysis	MS464xB-031 requires Option 84 or 85.  For other available options, see <a href="#">“ME7838D Broadband/Millimeter-Wave System Options”</a>
Accessories	MS4640B-001, MS4640B Rack Mount 3739C-001, 3739C Rack Mount	
	35WR12WF-EE – Precision Waveguide to Coax Adapter Kit, 56 GHz to 94 GHz, WR-12 to W1 (f) 35WR10WF-EW – Precision Waveguide to Coax Adapter Kit, 65 GHz to 110 GHz, WR-10 to W1 (f)	

**ME7838D Waveguide-Band System – VDI mmWave Modules**

ME7838D Waveguide-band System using VDI Millimeter-Wave modules:

Action	Part Number and Description	Additional Information
Choose and order one of the three base VectorStar models with options listed:	MS4642B VNA, 10 MHz to 20 GHz MS4640B-007, Receiver Offset MS4642B-061 or MS4642B-062 MS4642B-083	MS4642B-061 includes Active Device Measurements, with 2 Step Attenuators MS4642B-062 includes Active Device Measurements, with 4 Step Attenuators MS4642B-085 is ordered when Option 31 is included.
	MS4644B VNA, 10 MHz to 40 GHz MS4640B-007, Receiver Offset MS4644B-082 or -083 or -084 or -085	MS4644B-083 is ordered when Options 51, 61, or 62 are included. MS4644B-084 is ordered when Option 31 is included and Options 51, 61, or 62 are <i>excluded</i> . MS4644B-085 is ordered when Option 31 <i>and</i> Options 51, 61, or 62 are included.
	MS4647B VNA, 10 MHz to 70 GHz MS4640B-007, Receiver Offset MS4647B-080 or -081 or -084 or -085	MS4647B-081 is ordered when Options 51, 61, or 62 are included. MS4647B-084 is ordered when Option 31 is included and Options 51, 61, or 62 are <i>excluded</i> . MS4647B-085 is ordered when Option 31 <i>and</i> Options 51, 61, or 62 are included.
Order:	3739C mmWave Test Set SM6537 Interface Cables (2) for VDI mmWave Modules	Does not include DC cable. DC supply is provided by mmWave module power supply.
Choose and order one of the two appropriate millimeter-wave module combinations:	2 each TxRx transmission and reflection millimeter-wave modules 1 each TxRx transmission and reflection module, and 1 each Tx transmission only module	Choose appropriate VDI modules. Contact Anritsu Company for ordering information.
Add options if desired:	Option 51, or 61, or 62: MS464xB-051 – External VNA Loops MS464xB-061 – Active Measurement Suite, 2 Attenuators MS464xB-062 – Active Measurement Suite, 4 Attenuators MS4640B-070 – for 70 kHz operation in base VNA MS4640B-002 – for Time Domain MS464xB-031 – Dual Source Architecture MS4640B-035 – IF Digitizer MS4640B-041 – Noise Figure MS4640B-042 – PulseView™ MS4640B-043 – DifferentialView™ MS4640B-048 – Differential Noise Figure MS4640B-049 – Spectrum Analysis	MS464xB-031 requires Option 84 or Option 85  For other available options, see <a href="#">“ME7838D Broadband/Millimeter-Wave System Options”</a>

**Calibration/Verification Kits**

- 3659 0.8 mm Calibration/Verification Kit
- 3656C W1 (1.0 mm) Calibration/Verification Kit
- 3656C-3 W1 (1.0 mm) Calibration/Verification Kit, With .s1p Characterization Files
- 3656C-5 W1 (1.0 mm) Calibration Kit
- 3656C-6 W1 (1.0 mm) Calibration Kit, With .s1p Characterization Files
- 3655V WR-15 Waveguide Calibration Kit, Without Sliding Loads
- 3655V-1 WR-15 Waveguide Calibration Kit, With Sliding Loads
- 3655E WR-12 Waveguide Calibration Kit, Without Sliding Loads
- 3655E-1 WR-12 Waveguide Calibration Kit, With Sliding Loads
- 3655W WR-10 Waveguide Calibration Kit, Without Sliding Loads
- 3655W-1 WR-10 Waveguide Calibration Kit, With Sliding Loads
- 3650A SMA/3.5 mm Calibration Kit, Without Sliding Loads
- 3652A K Calibration Kit, With Pin Depth Gauge
- 3652A-2 K Calibration Kit, With No Pin Depth Gauge
- 3652A-3 K Calibration Kit, With Pin Depth Gauge and .s1p Characterization Files
- 3652A-4 K Calibration Kit, With .s1p Characterization Files
- 3654D V Calibration Kit, With Pin Depth Gauge
- 3654D-2 V Calibration Kit, With No Pin Depth Gauge
- 3654D-3 V Calibration Kit, With Pin Depth Gauge and .s1p Characterization Files
- 3654D-4 V Calibration Kit, With .s1p Characterization Files

**External Power Meters/Sensors**

ML243xA	CW Power Meter, Single Input or Dual Input Recommended Power Sensors: • SC7770 • MA247xD • MA244xD • MA248xD • MA2400xA
ML248xB	Wideband Power Meter, Single Input or Dual Input Recommended Power Sensors: • MA249xA • MA2411B
ML249xA	Pulse Power Meter, Single Input or Dual Input Recommended Power Sensors: • MA249xA • MA2411B
MA24106A	USB Power Sensor, 50 MHz to 6 GHz
MA24108A	USB Power Sensor, 10 MHz to 8 GHz
MA24118A	USB Power Sensor, 10 MHz to 18 GHz
MA24126A	USB Power Sensor, 10 MHz to 26 GHz
MA24330A	USB Power Sensor, 10 MHz to 33 GHz
MA24340A	USB Power Sensor, 10 MHz to 40 GHz
MA24350A	USB Power Sensor, 10 MHz to 50 GHz
MA24507A	Power Master™ Frequency Selectable mmWave Power Analyzer, 9 kHz to 70 GHz
MA24510A	Power Master™ Frequency Selectable mmWave Power Analyzer, 9 kHz to 110 GHz Note that usage of the MA24507A or MA24510A Power Master™ sensor requires connection to two USB ports to supply needed current draw.

**Test Port Cables, Flexible, High Performance**

3671W1-50-1	1.0 mm (male) to 1.0 mm (female), 1 each, 10.0 cm (3.9 in)
3671W1-50-2	1.0 mm (male) to 1.0 mm (female), 1 each, 13.0 cm (5.1 in)
3671W1-50-3	1.0 mm (male) to 1.0 mm (female), 1 each, 16.0 cm (6.3 in)
3671KFS50-60	K (female) to 3.5 mm (male) cable, 60 cm (one cable)
3671KFK50-60	K (female) to K (male) cable, 60 cm (one cable)
3671KFK50-100	K (female) to K (male) cable, 1 each, 100 cm (one cable)
3671KFKF50-60	K (female) to K (female) cable, 1 each, 60 cm (one cable)
3671VVF50-60	V (female) to V (male) cable, 1 each, 60 cm (one cable)
3671VVF50-100	V (female) to V (male) cable, 1 each, 100 cm (one cable)
3671KFSF50-60	K (female) to 3.5 mm (female) cable, 1 each, 60 cm (one cable)
3671VVF50-60	V (female) to V (female) cable, 1 each, 60 cm (one cable)
3671VVF50-100	V (female) to V (male) cable, 1 each, 60 cm (one cable)
3670.850-1	0.8 mm (male) to 0.8 mm (female), 1 each, 10.0 cm (3.9 in)
3670.850-2	0.8 mm (male) to 0.8 mm (female), 1 each, 16.0 cm (6.3 in)
3670W50-1	DC to 110 GHz, W1(m) to W1(f), 10.0 cm
3670W50-2	DC to 110 GHz, W1(m) to W1(f), 16.0 cm

**Adapters**

0.8-105F	0.8 mm (female) Sparkplug Launcher Connector, DC to 145 GHz
0.8-105M	0.8 mm (male) Sparkplug Launcher Connector, DC to 145 GHz
34WV50	1.0 mm (male) to V (male) Adapter, 1.0 mm to V, Coaxial
34WVF50	1.0 mm (male) to V (female) Adapter, 1.0 mm to V, Coaxial
34WVF50	1.0 mm (female) to V (male) Adapter, 1.0 mm to V, Coaxial
34WVF50	1.0 mm (female) to V (female) Adapter, 1.0 mm to V, Coaxial
33WW50	1.0 mm (male) to 1.0 mm (male) Adapter, 1.0 mm in-series, Coaxial
33WWF50	1.0 mm (male) to 1.0 mm (female) Adapter, 1.0 mm in-series, Coaxial
33WVF50	1.0 mm (female) to 1.0 mm (female) Adapter, 1.0 mm in-series, Coaxial
35WR10W	WR10 to 1.0 mm (male) Adapter, 1.0 mm to WR10 Waveguide
35WR10WF	WR10 to 1.0 mm (female) Adapter, 1.0 mm to WR10 Waveguide
SC7260	WR12 to 1.0 mm (male) Adapter, 1.0 mm to WR12 Waveguide
SC7442	WR12 to 1.0 mm (female) Adapter, 1.0 mm to WR12 Waveguide
35WR15V	WR15 to V (male) Adapter, V (1.85 mm) to WR15 Waveguide
35WR15VF	WR15 to V (female) Adapter, V (1.85 mm) to WR15 Waveguide

For More Information Refer to **Precision RF & Microwave Components Catalog** for descriptions of adapters and other components.

**Miscellaneous Components**

41W-3	Attenuator, DC to 110 GHz, 0.2 W, 3 dB, W1(m) to W1(f), 50 Ω
41W-6	Attenuator, DC to 110 GHz, 0.2 W, 6 dB, W1(m) to W1(f), 50 Ω
41W-10	Attenuator, DC to 110 GHz, 0.2 W, 10 dB, W1(m) to W1(f), 50 Ω
W240A	Precision Power Divider, DC to 110 GHz, W1(f) input, W1(f) outputs, 3 resistor, 50 Ω
W241A	Precision Power Splitter, DC to 110 GHz, W1(m) input, W1(f) outputs, 2 resistor, 50 Ω
MN25110A	Precision Directional Coupler, 20 GHz to 110 GHz, W1(f) input, W1(f) output, W1(f) coupled port, 50 Ω
W255MF	Precision Ultra Wide Band Bias Tee, 50 kHz to 110 GHz, W1(m) input, W1(f) output, SMC(m) bias
W255FM	Precision Ultra Wide Band Bias Tee, 50 kHz to 110 GHz, W1(f) input, W1(m) output, SMC(m) bias
W265	Precision Ultra Wide Band DC Block, 50 kHz to 110 GHz
W252MF	Precision Ultra Wide Band Bias Tee, 100 MHz to 110 GHz, W1(m) input, W1(f) output, SMC(m) bias
W252FM	Precision Ultra Wide Band Bias Tee, 100 MHz to 110 GHz, W1(f) input, W1(m) output, SMC(m) bias

**Accessories**

SC8215	Kelvin Bias Tee, low frequency limit: 70 kHz, Max Voltage: 16 VDC, Max Current: 100 mA
SC7287	Kelvin Bias Tee, low frequency limit: 100 MHz, Max Voltage: 50 VDC, Max Current: 500 mA
SC8218	Triax (male) to SMC (female) Cable, (Inner-shield floating at SMC end), 1.5 m (60 in) long two (2) needed per Kelvin Bias Tee
SM6494	System floor console (includes larger size writing table)
2100-2-R	GPIB cable, 2 m (79 in) long
2100-4-R	GPIB cable, 4 m (157 in) long
806-206-R	Flexible Coaxial Cable, DC to 70 GHz, 24 in (61 cm), V(m) – V(f), 50Ω
806-209-R	Flexible Coaxial Cable, DC to 70 GHz, 36 in (91.5 cm), V(m) – V(f), 50Ω
01-201	Torque Wrench (for tightening male devices), 8 mm (5/16 in), 0.9 N·m (8 lbf·in) for SMA, 3.5 mm, 2.4 mm, K, and V connectors
01-202	Universal Test Port Connector Wrench
01-203	Torque Wrench (for tightening the VNA test ports to female devices) 20.6 mm (13/16 in), 0.9 N·m (8 lbf·in)
01-204	Anritsu Stainless Steel Connector Wrench, circular, open-ended for SMA, 3.5 mm, 2.4 mm, K and V connectors
01-504	Torque wrench (for tightening male devices) 6 mm, 0.45 N·m (4 lbf·in) for 1.0 mm and 0.8 mm connectors
01-524	Low profile Torque Wrench (for tightening male devices), 6 mm, 0.45 N·m (4 lbf·in), 126 mm long for 1.0 mm and 0.8 mm connectors

**Additional Accessories**

0.8 mm to Waveguide adapters available from Flann Microwave Ltd  
0.8 mm Infinity probes available from Cascade Microtech

## Training at Anritsu

Anritsu has designed courses to help you stay up to date with technologies important to your job. For available training courses, visit: [www.anritsu.com](http://www.anritsu.com) and search for training and education.



### • United States

#### **Anritsu Americas Sales Company**

490 Jarvis Drive, Morgan Hill, CA 95037-2809, U.S.A.  
Phone: +1-800-Anritsu (1-800-267-4878)

### • Canada

#### **Anritsu Electronics Ltd.**

#### **Americas Sales and Support**

490 Jarvis Drive, Morgan Hill, CA 95037-2809, U.S.A.  
Phone: +1-800-Anritsu (1-800-267-4878)

### • Brazil

#### **Anritsu Eletronica Ltda.**

Praça Amadeu Amaral, 27 - 1 Andar  
01327-010 - Bela Vista - Sao Paulo - SP, Brazil  
Phone: +55-11-3283-2511  
Fax: +55-11-3288-6940

### • Mexico

#### **Anritsu Company, S.A. de C.V.**

Blvd Miguel de Cervantes Saavedra #169 Piso 1,  
Col. Granada, Mexico, Ciudad de Mexico,  
11520, MEXICO  
Phone: +52-55-4169-7104

### • United Kingdom

#### **Anritsu EMEA Limited**

900 Capability Green,  
Luton, Bedfordshire, LU1 3LU, U.K.  
Phone: +44-1582-433200  
Fax: +44-1582-731303

### • France

#### **Anritsu SA**

12 avenue du Québec, Immeuble Goyave,  
91140 VILLEBON SUR YVETTE, France  
Phone: +33-1-60-92-15-50

### • Germany

#### **Anritsu GmbH**

Nemetschek Haus, Konrad-Zuse-Platz 1,  
81829 München, Germany  
Phone: +49-89-442308-0  
Fax: +49-89-442308-55

### • Italy

#### **Anritsu S.R.L.**

Spaces Eur Arte, Viale dell'Arte 25, 00144 Roma, Italy  
Phone: +39-6-509-9711

### • Sweden

#### **Anritsu AB**

Kistagången 20 B, 2 tr, 164 40 Kista, Sweden  
Phone: +46-8-534-707-00

### • Finland

#### **Anritsu AB**

Technopolis Aviapolis, Teknobulevardi 3-5 (D208.5),  
FI-01530 Vantaa, Finland  
Phone: +358-20-741-8100

### • Denmark

#### **Anritsu A/S**

c/o Regus Winghouse, Ørestads Boulevard 73, 4th floor,  
2300 Copenhagen S, Denmark  
Phone: +45-7211-2200

### • Spain

#### **Anritsu EMEA Ltd.**

#### **Representation Office in Spain**

Calle Manzanares 4, Primera planta, 28005  
Madrid, Spain  
Phone: +34-91-572-6761

### • Austria

#### **Anritsu Pty Ltd**

Am Belvedere 10, A-1100 Vienna, Austria  
Phone: +43-(0)1-717-28-710

### • United Arab Emirates

#### **Anritsu EMEA Ltd.**

#### **Anritsu A/S**

Office No. 164, Building 17, Dubai Internet City  
P. O. Box - 501901, Dubai, United Arab Emirates  
Phone: +971-4-3758479

### • India

#### **ANRITSU INDIA PRIVATE LIMITED**

6th Floor, Indiqube ETA, No.38/4, Adjacent to EMC2,  
Doddanekundi, Outer Ring Road,  
Bengaluru - 560048, India  
Phone: +91-80-6728-1300  
Fax: +91-80-6728-1301

### • Singapore

#### **ANRITSU PTE LTD**

1 Jalan Kilang Timor, #07-04/06 Pacific Tech Centre  
Singapore 159303  
Phone: +65-6282-2400  
Fax: +65-6282-2533

### • Vietnam

#### **ANRITSU COMPANY LIMITED**

16th Floor, Peakview Tower, 36 Hoang Cau Street,  
O Cho Dua Ward, Dong Da District, Hanoi, Vietnam  
Phone: +84-24-3201-2730  
Fax: +84-24-3201-2740

### • P.R. China (Shanghai)

#### **Anritsu (China) Co., Ltd.**

Room 2701-2705, Tower A, New Caohejing  
International Business Center No. 391 Gui Ping Road  
Shanghai, 200233, P.R. China  
Phone: +86-21-6237-0898  
Fax: +86-21-6237-0899

### • P.R. China (Hong Kong)

#### **ANRITSU COMPANY LIMITED**

Unit 1302, 13<sup>th</sup> Floor, New East Ocean Center,  
No.9 Science Museum Road, TsimShaTsui East,  
Kowloon, Hong Kong  
Phone: +852-2301-4980  
Fax: +852-2301-3545

### • Japan

#### **Anritsu Corporation**

8-5, Tamura-cho, Atsugi-shi, Kanagawa, 243-0016 Japan  
Phone: +81-46-296-6509  
Fax: +81-46-225-8352

### • South Korea

#### **Anritsu Corporation, Limited**

8F, A TOWER, 20, Gwacheondaero 7-gil, Gwacheon-si,  
Gyeonggi-do, 13840, Republic of Korea  
Phone: +82-2-6259-7300  
Fax: +82-2-6259-7301

### • Australia

#### **Anritsu Pty. Ltd.**

Unit 20, 21-35 Ricketts Road,  
Mount Waverley, Victoria 3149, Australia  
Phone: +61-3-9558-8177  
Fax: +61-3-9558-8255

### • Taiwan

#### **ANRITSU COMPANY, INC.**

7F, No. 316, Sec. 1, NeiHu Rd., Taipei 114, Taiwan  
Phone: +886-2-8751-1816  
Fax: +886-2-8751-1817

List Revision Date: 20250812