

Anritsu Advancing beyond

VectorStar™

High Performance, Broadband Network Analysis Solutions

ME7838EX — 2-Port Series Vector Network Analyzers

ME7838E4X — 4-Port Series Vector Network Analyzers

Broadband VNA System
Millimeter Waveguide VNA System

70 kHz to 110 GHz
50 GHz to 1.1 THz



ME7838EX/E4X Introduction

- Industry-best broadband frequency coverage – starts at 70 kHz instead of 10 MHz and is operational from 40 kHz to 110 GHz.
- Industry-best calibration and measurement stability – 0.1 dB vs 0.6 dB over 24 hrs.
- Industry-best compact, lightweight mmWave modules for easy, precise, and economical positioning on the wafer probe station – 0.6 vs 7.6 lb and 1/50 the volume.
- Thin film multipliers, receivers, and couplers at the test port, offering best raw directivity and providing excellent calibration and measurement stability.
- The industry's only available mmWave real time electronic power leveling – eliminates time-lagging software correction tables.
- Compatibility with all major probe stations.
- Kelvin bias tees for sense and force capabilities closely positioned to the DUT.

A detailed color brochure available on the Anritsu website provides descriptions and examples of the VectorStar family's features and benefits:

<https://www.anritsu.com/test-measurement/products/ms4640b-series>

ME7838EX Broadband VNA System 70 kHz to 110 GHz

The ME7838EX Broadband VNA System provides single sweep coverage from 70 kHz to 110 GHz. It consists of the following items:

- MS4647B VectorStar VNA, 70 kHz to 70 GHz with Option 7, Option 70, and Option 86/87 or Option 88/89
- 3739C Broadband Millimeter-Wave Test Set and Interface Cables
- 3743EX Millimeter-Wave Modules, 2 each

ME7838EX Millimeter Waveguide VNA System 50 GHz to 1.1 THz

The ME7838EX mmWave configuration provides waveguide output from 50 GHz to 1.1 THz in waveguide bands. The system can extend the broadband system or be configured to operate only as a waveguide system. It consists of the following items:

- MS464xB VectorStar™ VNA, with Option 7 and Option 86/87 or Option 88/89
- 3739C Broadband/Millimeter-Wave Test Set and Interface Cables
- Banded Millimeter-Wave modules, 2 each

ME7838E4X 4-Port Broadband VNA System 70 kHz to 110 GHz

The VectorStar ME7838E4X system is similar to the ME7838EX system, except it is configured for 4-port measurements.

It consists of:

- MS4647B VectorStar VNA, 70 kHz to 70 GHz with Option 7, Option 70, and Option 87/89
- 3739C Broadband mmWave Test Set and Interface Cables
- 3743EX Broadband mmWave modules, 4 each
- 3736B Broadband mmWave Test Set and Interface Cables
- MN4697C Four Port Test Set and Interface cables

ME7838E4X 4-Port Millimeter Waveguide VNA System 50 GHz to 1.1 THz

The ME7838E4X mmWave configuration provides waveguide output from 50 GHz to 1.1 THz in waveguide bands. The system can extend the broadband system or be configured to operate only as a waveguide system. It consists of the following items:

- MS4647B VectorStar VNA, 70 kHz to 70 GHz with Option 7 and Option 87/89
- 3739C Broadband mmWave Test Set and Interface Cables
- mmWave modules, 4 each
- 3736B Broadband mmWave Test Set and Interface Cables
- MN4697C Four Port Test Set and Interface cables

Standard Capabilities for All Configurations

For standard capabilities of the VectorStar VNAs, please see the VectorStar MS4640B Series VNA Technical Data Sheet – 11410-00611, available at www.anritsu.com.

Table of Contents Table of Contents 3

Definitions 3

Broadband Configuration 4

Dynamic Range Specifications 7

Corrected System Performance and Uncertainties 13

Broadband Measurement Examples 16

Dynamic Range Specifications 24

Power Specifications 25

Corrected System Performance and Uncertainties 29

Waveguide Band Configuration 34

Waveguide Band Specifications 36

Millimeter-Wave Noise Figure Measurements with Option 41/48 and 3744E-Rx 41

Waveguide Bands from 50 GHz to 1.1 THz 43

Mechanical and Environmental 47

Regulatory Compliance 47

Warranty 47

Calibration and Correction Capabilities 48

Mechanical Calibration/Verification Kits 49

Test Port Cables 50

Precision Adapters, Attenuators, and Other Components 51

Ordering Information 52

Documentation 57

Definitions

	All specifications and characteristics apply under the following conditions, unless otherwise stated:
Warm-Up Time	After 90 minutes of warm-up time, where the instrument is left in the ON state.
Temperature Range	Over the 25 °C ± 5 °C temperature range.
Error-Corrected Specifications	For error-corrected specifications, over 23 °C ± 3 °C, with < 1 °C variation from calibration temperature. For error-corrected specifications are warranted and include guard bands, unless otherwise stated.
Typical Performance	"Typical" specifications describe expected, but not warranted, performance based on sample testing. Typical performance indicates the measured performance of an average unit and do not guarantee the performance of any individual product. "Typical" specifications do not account for measurement uncertainty and are shown in parenthesis, such as (-102 dB), or noted as Typical.
User Cables/Adapters	Specifications do not include effects of any user cables, adapters, fixtures or other structures attached to the instrument.
Discrete Spurious Responses	Specifications may exclude discrete spurious responses.
Internal Reference Signal	All specifications apply with internal 10 MHz Crystal Oscillator Reference Signal.
Characteristic Performance	Characteristic performance indicates a performance designed-in and verified during the design phase. It does include guard-bands and is not covered by the product warranty.
Below 300 kHz	All uncertainties below 300 kHz are typical.
Recommended Calibration Cycle	12 months
Interpolation Mode	All specifications are with Interpolation Mode Off.
Specifications Subject to Change	All specifications subject to change without notice. For the most current data sheet, please visit the Anritsu web site at www.anritsu.com .

The instrument may be protected by one or more of the following patents: 6894581, 7088111, 7545151, 7683633, 7924024, 8185078, 8306134, 8417189, 8718586, 9103873, 9606212, 9753071, 10788529, 10225073, 11558129, 11112447 depending on the model and option configuration of the instrument.

Broadband Configuration

ME7838EX 2-Port Broadband Hardware Configuration

The ME7838EX 2-port broadband VNA system provides single sweep coverage from 70 kHz to 110 GHz. It consists of the following items:

VNA	MS4647B VectorStar VNA, 70 kHz to 70 GHz with Option 7, Option 70, and Option 86/87/88/89
Test Set	3739C Broadband Test Set and interface cables
mmWave Modules	3743EX Millimeter-Wave Modules, 2 each

ME7838E4X 4-Port Broadband Hardware Configuration

The ME7838E4X 4-port broadband VNA system provides single sweep coverage from 70 kHz to 110 GHz and is operational from 40 kHz to 110 GHz. It consists of the following items:

Broadband VNA	ME7838EX Broadband VNA System with Option 51, 61, or 62
4-Port Test Set	MN4697C 2U 4-Port Test Set
mmWave Modules	3743EX Millimeter-Wave Modules, 2 each (two incremental to the modules in the ME7838EX)
Test Set	3736B Broadband Test Set with Cables

ME7838EX/E4X Broadband/Millimeter-Wave System Options

The major ME7838EX/E4X broadband VNA system options are:

Option 02	MS4640B-002 – Time Domain
Option 21	MS4640B-021 – Universal Fixture Extraction
Option 31	MS464xB-031 – Dual Source Architecture
Option 32	MS464xB-032 – Internal RF Combiner
Option 35	MS4640B-035 – IF Digitizer
Option 36	MS4640B-036 – Extended IF Digitizer Memory
Option 41	MS4640B-041 – Noise Figure
Option 42	MS4640B-042 – PulseView™
Option 43	MS4640B-043 – DifferentialView™
Option 44	MS4640B-044 – IMDView™
Option 46	MS4640B-046 – Fast CW
Option 47	MS4640B-047 – Eye Diagram
Option 48	MS4640B-048 – Differential Noise Figure
Option 49	MS4640B-049 – Spectrum Analysis
Option 51	MS464xB-051 – External VNA Direct Access Loops
Option 61	MS464xB-061 – Active Measurement Suite, with 2 Attenuators
Option 62	MS464xB-062 – Active Measurement Suite, with 4 Attenuators
Bias Tees	SC8215 and SC7287 – Kelvin Bias Tees
Waveguide Modules	3744E-EE - 56 to 95 GHz WR-12 Waveguide Module
	3744E-EW - 65 to 110 GHz WR-10 Waveguide Module

ME7838EX 2-Port VNA



ME7838EX 2-Port VNA

ME7838EX 2-port Broadband System

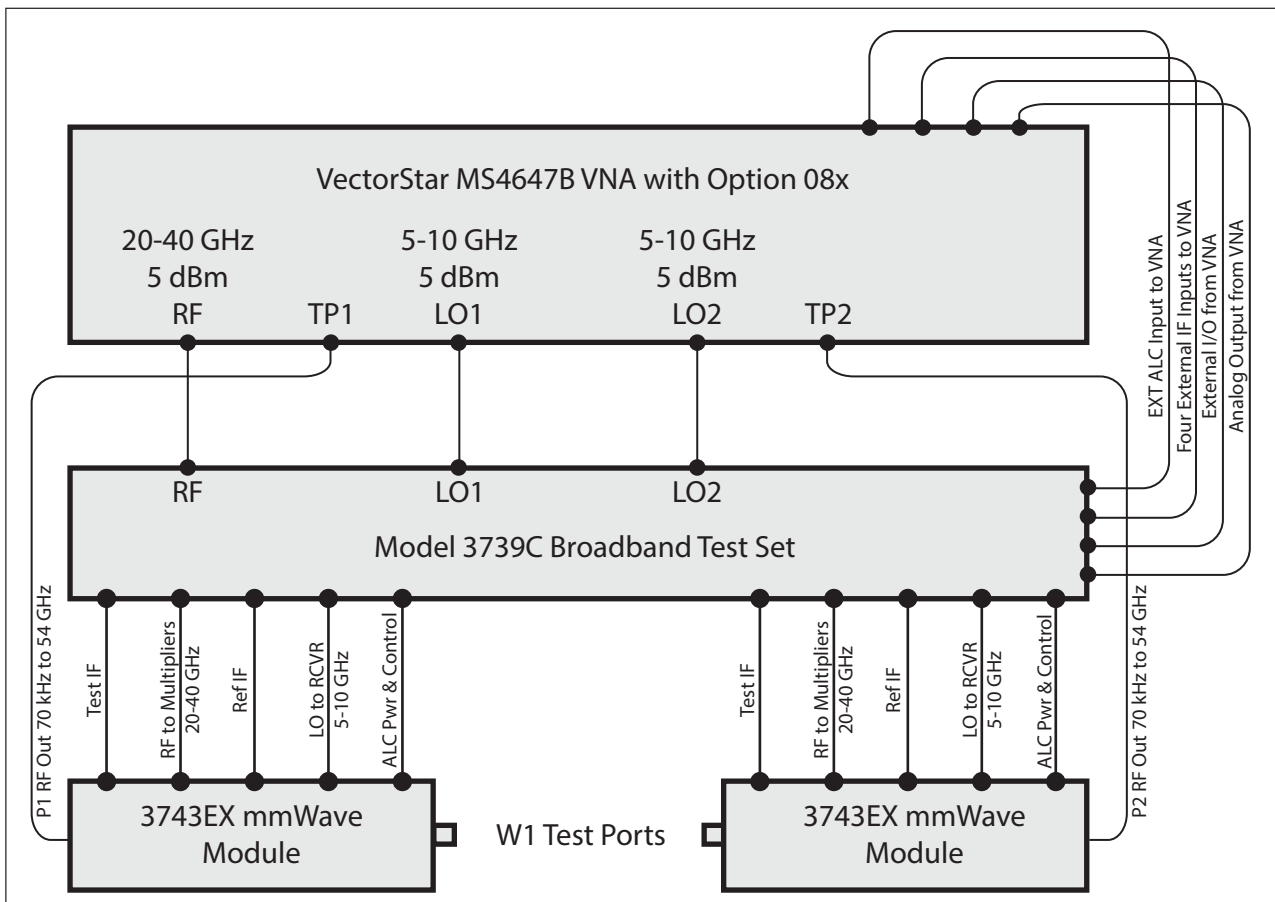

ME7838EX 2-port Broadband System

ME7838EX 2-port mmWave System

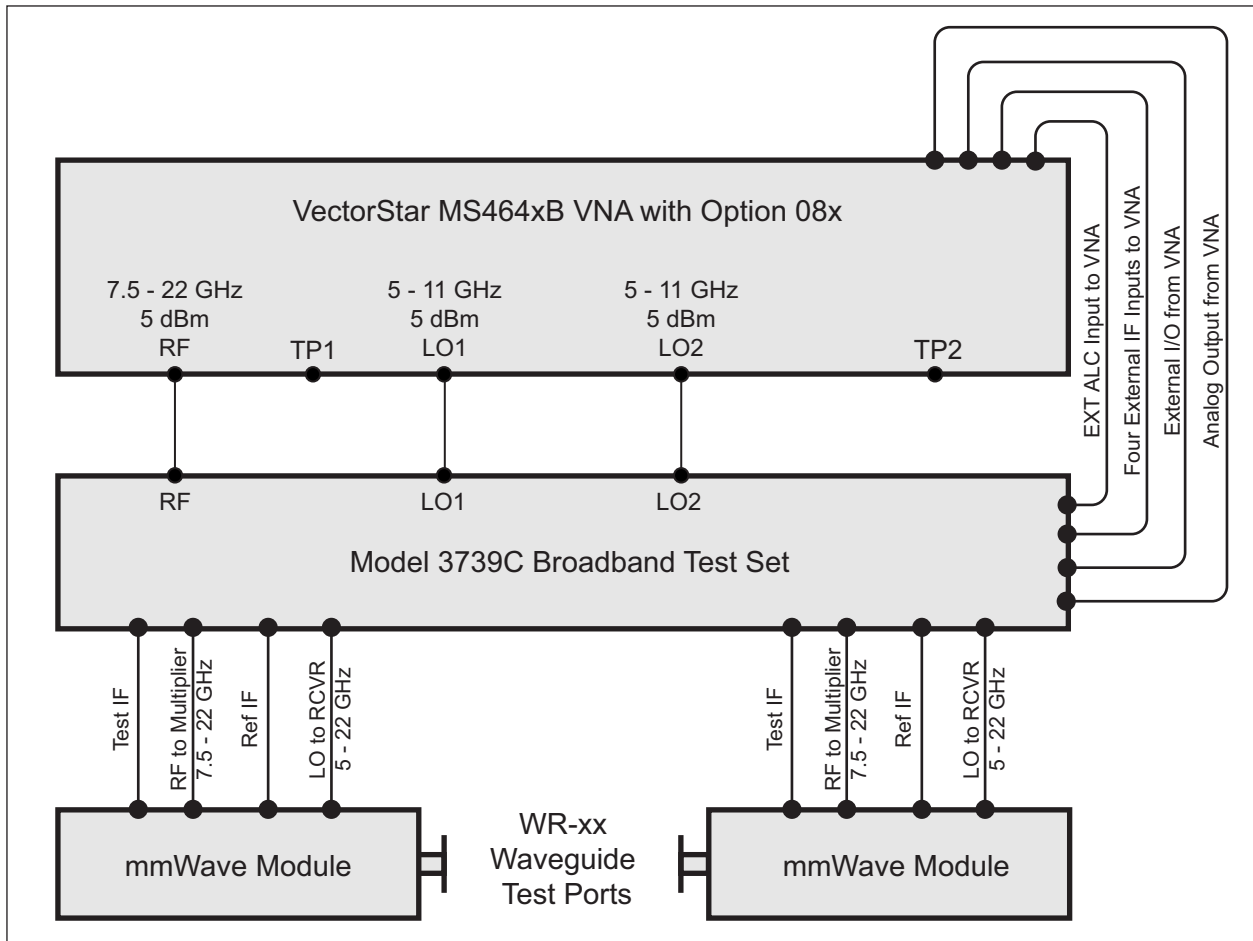

ME7838EX 2-port mmWave System

Dynamic Range Specifications

System Dynamic Range (Excludes localized spurious responses and crosstalk)

System Dynamic Range is measured as the difference between maximum port power and the RMS noise floor in a 10 Hz bandwidth and no averaging (ports terminated).

Normalizing Measurement is made with a through line connection, with its effects compensated for. The cables between the VNA and the 3743AX modules are assumed to be the 806-206-R 1.85 mm cable (61 cm, 24 in long) or the 806-209-R 1.85 mm cable (91.5 cm, 36 in long).

ME7838EX^a

Specifications (Typical) [dB]

Frequency Range	No Options	Option 51 ^b	Option 61 or 62	Option 31 ^c	Option 31 ^{b,c} and Option 51	Option 31 ^c and Option 61 or 62
70 to 300 kHz	95 (110)	95 (110)	95 (108)	97 (112)	97 (112)	97 (110)
> 0.3 to 2 MHz	107 (120)	107 (120)	107 (120)	109 (122)	109 (122)	109 (122)
> 2 to 10 MHz	130 (140)	130 (140)	130 (140)	131 (140)	131 (140)	130 (140)
> 0.01 to < 2.5 GHz	119 (130)	118 (129)	117 (125)	121 (133)	120 (132)	119 (128)
2.5 to 10 GHz	117 (125)	115 (123)	113 (121)	120 (127)	118 (125)	116 (123)
> 10 to 24 GHz	109 (120)	106 (117)	113 (121)	114 (122)	109 (119)	107 (115)
> 24 to 40 GHz ^d	107 (115)	105 (113)	103 (112)	114 (118)	110 (116)	107 (115)
> 40 to 54 GHz ^d	107 (115)	104 (112)	103 (112)	111 (120)	108 (117)	107 (117)
> 54 to 60 GHz	107 (116)	107 (116)	107 (116)	107 (116)	107 (116)	107 (116)
> 60 to 65 GHz	107 (116)	107 (116)	107 (116)	107 (116)	107 (116)	107 (116)
> 65 to 80 GHz	106 (116)	106 (116)	106 (116)	106 (116)	106 (116)	106 (116)
> 80 to 90 GHz	104 (110)	104 (110)	104 (110)	104 (110)	104 (110)	104 (110)
> 90 to 100 GHz	104 (110)	104 (110)	104 (110)	104 (110)	104 (110)	104 (110)
> 100 to 110 GHz	104 (110)	104 (110)	104 (110)	104 (110)	104 (110)	104 (110)

a. Excludes localized spurious responses and crosstalk.

b. Also ME7838EX Option 61, S12 values.

c. Values shown are for port 1. For port 2, the dynamic range is degraded by 2 dB at low frequency to 5 dB at 54 GHz (typical). Frequencies above 54 GHz are unaffected.

d. If Option 35 is installed, dynamic range is degraded by 3 dB.

Receiver Dynamic Range (Excludes localized spurious responses and crosstalk)

Calculated as the difference between the receiver compression level and the noise floor at Ports 1 or 2.

Normalizing measurement is made with a through line connection, with its effects compensated for. The cables between the VNA and the 3743EX modules are assumed to be the 806-206-R 1.85 mm cable (61 cm, 24 in long) or the 806-209-R 1.85 mm cable (91.5 cm, 36 in long).

ME7838EX^a

Specifications (Typical) [dB]

Frequency Range	No Options	Option 51 ^b	Option 61 or 62	Option 31	Option 31, and Option 51 ^b	Option 31 and Option 61 or 62
70 to 300 kHz	91 (103)	91 (103)	94 (102)	93 (105)	93 (105)	96 (104)
> 0.3 to 2 MHz	107 (117)	107 (117)	112 (120)	109 (119)	109 (119)	114 (122)
> 2 to 10 MHz	128 (135)	128 (135)	132 (137)	129 (135)	129 (135)	132 (137)
> 0.01 to < 2.5 GHz	120 (128)	120 (127)	122 (125)	120 (129)	120 (128)	122 (126)
2.5 to 10 GHz	124 (128)	123 (127)	124 (127)	124 (128)	123 (127)	124 (127)
> 10 to 24 GHz	121(128)	119 (116)	128 (130)	124 (128)	120 (127)	120 (125)
> 24 to 40 GHz ^c	119 (122)	119 (122)	117 (121)	124 (123)	122 (123)	119 (122)
> 40 to 54 GHz ^c	124 (127)	124 (127)	124 (127)	124 (127)	124 (126)	124 (127)
> 54 to 60 GHz	119 (125)	119 (125)	119 (125)	119 (125)	119 (125)	119 (125)
> 60 to 65 GHz	119 (124)	119 (124)	119 (124)	119 (124)	119 (124)	119 (124)
> 65 to 70 GHz	122 (127)	122 (127)	122 (127)	122 (127)	122 (127)	122 (127)
> 70 to 80 GHz	120.5 (127)	120.5 (127)	120.5 (127)	120.5 (127)	120.5 (127)	120.5 (127)
> 80 to 90 GHz	120.5 (122)	120.5 (122)	120.5 (122)	120.5 (122)	120.5 (122)	120.5 (122)
> 90 to 100 GHz	116.5 (118)	116.5 (118)	116.5 (118)	116.5 (118)	116.5 (118)	116.5 (118)
> 100 to 110 GHz	120.5 (123)	120.5 (123)	120.5 (123)	120.5 (123)	120.5 (123)	120.5 (123)

a. Excludes localized spurious responses and crosstalk.

b. Also ME7838EX Option 61, S12 values.

c. If Option 35 is installed, dynamic range is degraded by 3 dB.

Maximum Power

Port power control is provided by the base VNA for frequencies below 54 GHz, and by the 3743EX mmWave module for frequencies greater than 54 GHz.

ME7838EX^a

Specifications (Typical) [dBm]

Frequency Range	No Options	Option 51 ^b	Option 61 or 62	Option 31 ^c	Option 31 and Option 51 ^{b,c}	Option 31 and Option 61 or 62 ^c
70 to 300 kHz	10 (13)	10 (13)	7 (12)	10 (13)	10 (13)	7 (12)
> 0.3 to 2 MHz	10 (13)	10 (13)	7 (12)	10 (13)	10 (13)	7 (12)
> 2 to 10 MHz	12 (15)	12 (15)	10 (15)	12 (15)	12 (15)	10 (15)
> 0.01 to < 2.5 GHz	10 (13)	9 (13)	8 (13)	12 (15)	11 (15)	10 (15)
2.5 to 10 GHz	4 (8)	3 (7)	2 (7)	7 (10)	6 (9)	5 (9)
> 10 to 24 GHz	-1 (3)	-2 (2)	-2 (1)	1 (5)	0 (3)	0 (3)
> 24 to 40 GHz	-2 (3)	-4 (1)	-4 (1)	0 (5)	-2 (3)	-2 (3)
> 40 to 54 GHz	-7 (-2)	-10 (-5)	-11 (-5)	-3 (3)	-6 (1)	-7 (0)
> 54 to 60 GHz	-2 (1)	-2 (1)	-2 (1)	-2 (1)	-2 (1)	-2 (1)
> 60 to 65 GHz	-2 (2)	-2 (2)	-2 (2)	-2 (2)	-2 (2)	-2 (2)
> 65 to 70 GHz	-6 (-1)	-6 (-1)	-6 (-1)	-6 (-1)	-6 (-1)	-6 (-1)
> 70 to 80 GHz	-4.5 (-1)	-4.5 (-1)	-4.5 (-1)	-4.5 (-1)	-4.5 (-1)	-4.5 (-1)
> 80 to 90 GHz	-6.5 (-2)	-6.5 (-2)	-6.5 (-2)	-6.5 (-2)	-6.5 (-2)	-6.5 (-2)
> 90 to 100 GHz	-2.5 (2)	-2.5 (2)	-2.5 (2)	-2.5 (2)	-2.5 (2)	-2.5 (2)
> 100 to 110 GHz	-6.5 (-3)	-6.5 (-3)	-6.5 (-3)	-6.5 (-3)	-6.5 (-3)	-6.5 (-3)

a. Using the 806-206-R 1.85 mm (61 cm, 24 in long) test port cables between the VNA and the 3743EX mmWave modules.

b. Also ME7838EX Option 61, S12 values.

c. Values shown are for port 1. For port 2, the maximum power is degraded by 2 dB at low frequency to 5 dB at 54 GHz (typical). Frequencies above 54 GHz are unaffected.

Power Range

ME7838EX

Specifications [dB]

Frequency Range	No Options	Option 51 ^a	Option 61 or 62	Option 31 ^b	Option 31 and Option 51 ^{a,b}	Option 31 and Option 61 or 62 ^b
70 to 300 kHz	10 to -25	10 to -25	7 to -85	10 to -25	10 to -25	7 to -85
> 0.3 to 2 MHz	10 to -25	10 to -25	7 to -85	10 to -25	10 to -25	7 to -85
> 2 to 10 MHz	12 to -25	12 to -25	10 to -85	12 to -25	12 to -25	10 to -85
> 0.01 to < 2.5 GHz	10 to -25	9 to -25	8 to -85	12 to -25	11 to -25	10 to -85
2.5 to 10 GHz	4 to -25	3 to -25	2 to -85	7 to -25	6 to -25	5 to -85
> 10 to 24 GHz	-1 to -25	-2 to -25	-2 to -85	1 to -25	0 to -25	0 to -85
> 24 to 40 GHz	-2 to -30	-4 to -30	-4 to -90	0 to -30	-2 to -30	-2 to -90
> 40 to 54 GHz	-7 to -30	-10 to -30	-11 to -90	-3 to -30	-6 to -30	-7 to -90
> 54 to 60 GHz	-2 to -55	-2 to -55	-2 to -55	-2 to -55	-2 to -55	-2 to -55
> 60 to 65 GHz	-2 to -55	-2 to -55	-2 to -55	-2 to -55	-2 to -55	-2 to -55
> 65 to 70 GHz	-6 to -55	-6 to -55	-6 to -55	-6 to -55	-6 to -55	-6 to -55
> 70 to 80 GHz	-4.5 to -55	-4.5 to -55	-4.5 to -55	-4.5 to -55	-4.5 to -55	-4.5 to -55
> 80 to 90 GHz	-6.5 to -55	-6.5 to -55	-6.5 to -55	-6.5 to -55	-6.5 to -55	-6.5 to -55
> 90 to 100 GHz	-2.5 to -55	-2.5 to -55	-2.5 to -55	-2.5 to -55	-2.5 to -55	-2.5 to -55
> 100 to 110 GHz	-6.5 to -55	-6.5 to -55	-6.5 to -55	-6.5 to -55	-6.5 to -55	-6.5 to -55

a. Also ME7838EX Option 61, S12 values.

b. Values shown are for port 1. For port 2, the maximum power is degraded by 2 dB at low frequency to 5 dB at 54 GHz (typical). Frequencies above 54 GHz are unaffected.

Power Level Accuracy and Linearity

Level accuracy Defined at -10 dBm or max rated power, whichever is lower.
 Linearity Defined as the incremental error between the accuracy test power level and 5 dB below.

**ME7838EX
 Specifications (Typical) [dB]**

Frequency Range	Accuracy	Resolution	Linearity
70 to 300 kHz	(± 0.3)	0.01	(± 0.2)
> 0.3 to 2 MHz	(± 0.3)	0.01	(± 0.2)
> 2 to 10 MHz	(± 0.3)	0.01	(± 0.2)
> 0.01 to < 2.5 GHz	(± 0.4)	0.01	(± 0.3)
2.5 to 10 GHz	(± 0.5)	0.01	(± 0.3)
> 10 to 24 GHz	(± 0.5)	0.01	(± 0.3)
> 24 to 40 GHz	(± 0.9)	0.01	(± 0.3)
> 40 to 54 GHz	(± 0.9)	0.01	(± 0.3)
> 54 to 60 GHz	(± 1.3)	0.01	(± 0.5)
> 60 to 65 GHz	(± 1.3)	0.01	(± 0.5)
> 65 to 80 GHz	(± 1.3)	0.01	(± 0.5)
> 80 to 90 GHz	(± 1.7)	0.01	(± 0.6)
> 90 to 100 GHz	(± 2.3)	0.01	(± 0.6)
> 100 to 110 GHz	(± 2.3)	0.01	(± 1)

Receiver Compression

Receiver compression point is defined as the port power level beyond which the response may be compressed more than 0.2 dB relative to normalization level. 10 Hz IF bandwidth used to remove trace noise effects.

**ME7838EX ^a
 (Typical) [dB]**

Frequency Range	Without Option 61 or 62	Option 61 or 62 ^b
70 to 300 kHz	(6)	(6)
> 0.3 to 2 MHz	(10)	(12)
> 2 to 10 MHz	(10)	(12)
> 0.01 to < 2.5 GHz	(11)	(13)
2.5 to 24 GHz	(11)	(13)
> 24 to 40 GHz	(10)	(10)
> 40 to 54 GHz	(10)	(10)
> 54 to 60 GHz	(10)	(10)
> 60 to 65 GHz	(10)	(10)
> 65 to 80 GHz	(10)	(10)
> 80 to 90 GHz	(10)	(10)
> 90 to 100 GHz	(10)	(10)
> 100 to 110 GHz	(10)	(10)

a. Using the 806-206-R 1.85 mm (61 cm, 24 in long) test port cables between the VNA and the 3743EX mmWave modules.

b. Applies only to Port 2 on Option 61 systems.

Trace Noise (High Level Noise)

Noise measured at 1 kHz IF bandwidth, at maximum power or compression limit (whichever is less), with through transmission. RMS.

ME7838EX**Specifications (Typical)**

Frequency Range	Magnitude [dB RMS]	Phase [deg. RMS]
70 to 500 kHz	0.040 (0.01)	0.3 (0.07)
> 0.5 to 2 MHz	0.006 (0.002)	0.03 (0.01)
> 2 to 10 MHz	0.0045 (0.0017)	0.03 (0.007)
> 0.01 to < 2.5 GHz	0.0045 (0.0017)	0.03 (0.007)
2.5 to 10 GHz	0.005 (0.002)	0.035 (0.01)
> 10 to 24 GHz	0.005 (0.002)	0.045 (0.02)
> 24 to 54 GHz	0.005 (0.002)	0.06 (0.03)
> 54 to 80 GHz	0.0045 (0.002)	0.075 (0.04)
> 80 to 110 GHz	0.006 (0.0025)	0.105 (0.05)

Noise Floor (Excludes localized spurious responses and crosstalk)

Noise floor is calculated as the difference between maximum rated port power and system dynamic range.

Normalizing measurement is made with a through line connection, with its effects compensated for. The cables between the VNA and the 3743EX modules are assumed to be the 806-206-R 1.85 mm cable (61 cm, 24 in long) or the 806-209-R 1.85 mm cable (91.5 cm, 36 in long).

ME7838EX**Specifications (Typical) [dB]**

Frequency Range	No Options	Option 51	Option 61 or 62	Option 31	Option 31 and Option 51	Option 31 and Option 61 or 62
70 to 300 kHz	-85 (-97)	-85 (-97)	-88 (-96)	-87 (-99)	-87 (-99)	-90 (-98)
> 0.3 to 2 MHz	-97 (-107)	-97 (-107)	-100 (-108)	-99 (-109)	-99 (-109)	-102 (-110)
> 2 to 10 MHz	-118 (-125)	-118 (-125)	-120 (-125)	-119 (-125)	-119 (-125)	-120 (-125)
> 0.01 to < 2.5 GHz	-109 (-117)	-109 (-116)	-109 (-112)	-109 (-118)	-109 (-117)	-109 (-113)
2.5 to 10 GHz	-113 (-117)	-112 (-116)	-111 (-114)	-113 (-117)	-112 (-116)	-111 (-114)
> 10 to 24 GHz	-110 (-117)	-108 (-115)	-115 (-120)	-113 (-117)	-109 (-116)	-107 (-112)
> 24 to 40 GHz ^a	-109 (-112)	-109 (-112)	-107 (-111)	-114 (-113)	-112 (-113)	-109 (-112)
> 40 to 54 GHz ^a	-114 (-117)	-114 (-117)	-114 (-117)	-114 (-113)	-114 (-116)	-114 (-117)
> 54 to 60 GHz	-109 (-115)	-109 (-115)	-109 (-115)	-109 (-115)	-109 (-115)	-109 (-115)
> 60 to 65 GHz	-109 (-114)	-109 (-114)	-109 (-114)	-109 (-114)	-109 (-114)	-109 (-114)
> 65 to 70 GHz	-112 (-117)	-112 (-117)	-112 (-117)	-112 (-117)	-112 (-117)	-112 (-117)
> 70 to 80 GHz	-110.5 (-117)	-110.5 (-117)	-110.5 (-117)	-110.5 (-117)	-110.5 (-117)	-110.5 (-117)
> 80 to 90 GHz	-110.5 (-112)	-110.5 (-112)	-110.5 (-112)	-110.5 (-112)	-110.5 (-112)	-110.5 (-112)
> 90 to 100 GHz	-106.5 (-108)	-106.5 (-108)	-106.5 (-108)	-106.5 (-108)	-106.5 (-108)	-106.5 (-108)
> 100 to 110 GHz	-110.5 (-113)	-109.5 (-113)	-109.5 (-113)	-109.5 (-113)	-109.5 (-113)	-109.5 (-113)

a. If Option 35 is installed, noise floor is degraded by 3 dB.

Source Phase Noise and Harmonics

Measured at default power.

ME7838EX**(Typical)**

Frequency Range	1 kHz Offset [dB/Hz]	10 kHz Offset [dB/Hz]	100 kHz Offset ^a [dB/Hz]	2nd Harmonic [dBc]	3rd Harmonic [dBc]
70 kHz to 10 MHz	(-86)	(-83)	(-88)	(-25)	(-30)
> 0.01 to < 2.5 GHz	(-90)	(-92)	(-96)	(-35)	(-35)
> 2.5 to 5 GHz	(-93)	(-94)	(-95)	(-35)	(-45)
> 5 to 10 GHz	(-86)	(-90)	(-90)	(-35)	(-45)
> 10 to 20 GHz	(-81)	(-84)	(-84)	(-40)	(-45)
> 20 to 26.5GHz	(-78)	(-81)	(-81)	(-30)	(-45)
> 26.5 to 40 GHz	(-72)	(-76)	(-78)	(-45)	(-45)
> 40 to 54 GHz	(-69)	(-73)	(-74)	(-45)	-
> 54 to 80 GHz	(-66)	(-70)	(-71)	(-40)	-
> 80 to 110 GHz	(-62)	(-66)	(-68)	-	-

a. Only applies for source frequencies > 300 kHz.

Magnitude and Phase Stability

Ratioed measurement at maximum leveled power and with nominally a full coaxial reflect or a stable coaxial thru over the normal specified temperature range.

ME7838EX (Typical)		
Frequency Range	Magnitude [dB/°C]	Phase [deg/°C]
70 to 300 kHz	(< 0.015)	(< 0.1)
> 0.3 to 2 MHz	(< 0.015)	(< 0.05)
> 2 to 10 MHz	(< 0.01)	(< 0.05)
> 0.01 to < 2.5 GHz	(< 0.01)	(< 0.05)
2.5 to 30 GHz	(< 0.01)	(< 0.09)
> 30 to 54 GHz	(< 0.01)	(< 0.07)
> 54 to 80 GHz	(< 0.015)	(< 0.1)
> 80 to 110 GHz	(< 0.015)	(< 0.15)

Uncorrected (Raw) Port Characteristics

ME7838EX (Typical)		
Frequency (GHz)	Directivity [dB]	Port Match [dB]
70 kHz to 10 MHz	(10 ^a)	(8)
> 0.01 to < 2.5	(9 ^a)	(10)
2.5 to 30	(5 ^a)	(12)
> 30 to 40	(5 ^a)	(5)
> 40 to 54	(10)	(5)
> 54 to 80	(10)	(10)
> 80 to 110	(5)	(7)

a. Raw directivity is degraded below 300 kHz, 2.2 to 2.5 GHz and in narrow bands within 10 to 34 GHz.

Frequency Resolution, Accuracy, and Stability

ME7838EX Specifications		
Resolution	Accuracy	Stability
1 Hz	± 5 x 10 ⁻⁷ Hz/Hz (at time of calibration)	< 5 x 10 ⁻⁹ /°C over 0 °C to 50 °C temperature < 1 x 10 ⁻⁹ /day aging, instrument on

Measurement Time Measurement times include sweep time, retrace time, and band-switching time.

Full Band, 70 kHz to 110 GHz, Display ON, and ALC ON.

ME7838EX (Typical) [ms]				
1 Port Cal IFBW	401 Points	1601 Points	10001 Points	25000 Points
1 MHz	(210)	(270)	(780)	(1,380)
30 kHz	(250)	(320)	(1,180)	(2,980)
10 kHz	(265)	(430)	(1,930)	(4,380)
1 kHz	(530)	(1,680)	(11,000)	(27,000)
10 Hz	(48,000)	(160,000)	(1,000,000)	(2,500,000)

2 Port Cal IFBW	401 Points	1601 Points	10001 Points	25000 Points
1 MHz	(420)	(540)	(1,560)	(2,760)
30 kHz	(500)	(640)	(2,360)	(5,960)
10 kHz	(530)	(860)	(3,860)	(8,760)
1 kHz	(1,060)	(3,360)	(22,000)	(54,000)
10 Hz	(96,000)	(320,000)	(2,000,000)	(5,000,000)

Measurement Time vs. System Dynamic Range

Full Band, Display ON, and ALC ON.

**ME7838EX
(Typical)**

Calibration	401 Points Measurement Time [ms]	Achieved System Dynamic Range (Opt 62 at 54 GHz) [dB]	IFBW and Averaging Used
Uncorrected or 1-port calibration	(285)	(77)	(10 kHz/no avg)
	(550)	(87)	(1 kHz/no avg)
2-port calibration	(570)	(77)	(10 kHz/no avg)
	(1100)	(87)	(1 kHz/no avg)

Corrected System Performance and Uncertainties

Corrected System Performance and Uncertainties – SOLT/SSST

With 12-term broadband calibration (concatenated SOLT and Triple Offset Short Calibration (SSST)), using the 3656C W1 Calibration Kit and .ccf component definitions. Cable flexure and drift effects are not included.

ME7838EX
(Typical) [dB]

Frequency	Directivity	Source Match	Load Match	Reflection Tracking	Transmission Tracking
70 kHz to 10 MHz	40 (46)	40 (46)	38 (44)	± 0.10 (± 0.05)	± 0.10 (± 0.05)
> 0.01 to < 2.5 GHz	40 (46)	40 (46)	38 (44)	± 0.05 (± 0.03)	± 0.05 (± 0.03)
2.5 to 20 GHz	40 (44)	40 (46)	38 (44)	± 0.05 (± 0.03)	± 0.05 (± 0.03)
> 20 to 40 GHz	36 (40)	38 (44)	33 (38)	± 0.05 (± 0.03)	± 0.07 (± 0.05)
> 40 to 67 GHz	30 (37)	36 (42)	27 (35)	± 0.05 (± 0.03)	± 0.07 (± 0.05)
> 67 to 90 GHz	30 (38)	34 (40)	30 (36)	± 0.07 (± 0.05)	± 0.07 (± 0.05)
> 90 to 110 GHz	30 (36)	34 (40)	28 (34)	± 0.07 (± 0.05)	± 0.07 (± 0.05)

Measurement Uncertainties – SOLT/SSST

The graphs give measurement uncertainties after the above calibration. The errors are worst case contribution of residual directivity, load and source match, frequency response and isolation, network analyzer dynamic accuracy, and connector repeatability while noise effects are added on an RSS basis. 10 Hz IF Bandwidth is used. For transmission uncertainties, it is assumed that $S_{11} = S_{22} = 0$. For reflection uncertainties, it is assumed that $S_{21} = S_{12} = 0$. For other conditions, please use our free Exact Uncertainty calculator software, downloadable from the Anritsu web site at www.anritsu.com.

ME7838EX
(Typical) [dB]

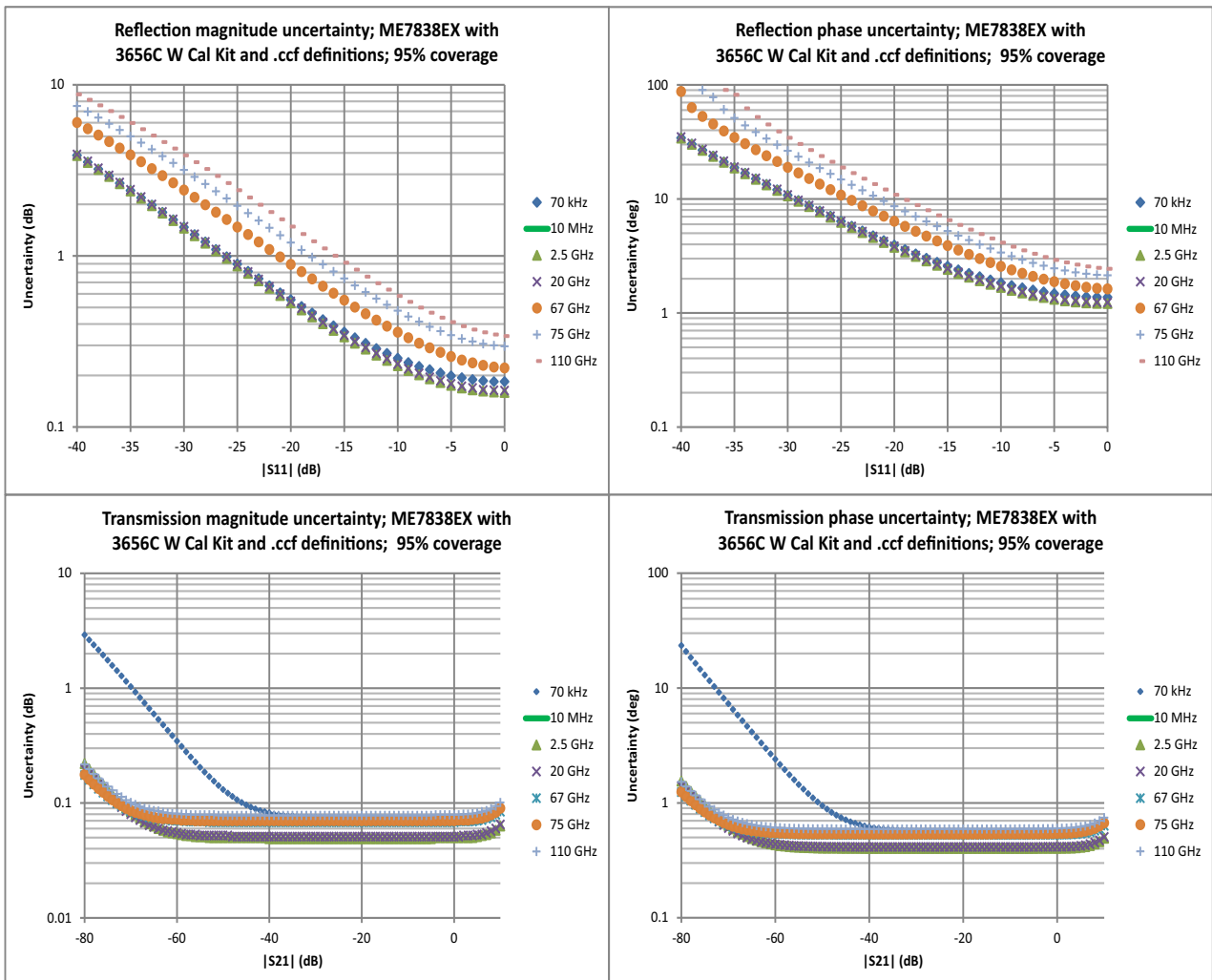

Corrected System Performance and Uncertainties – SOLT/SSST with .s1p Standards Definitions

With 12-term broadband calibration (concatenated SOLT and Triple Offset Short Calibration (SSST), using the 3656C-3 or -6 W1 Calibration Kit and .s1p component definitions. Cable flexure and drift effects are not included.

**ME7838EX
Specifications (Typical) [dB]**

Frequency	Directivity	Source Match	Load Match	Reflection Tracking	Transmission Tracking
70 kHz to 10 MHz	43 (50)	43 (50)	40 (43)	± 0.1 (±0.05)	± 0.1 (± 0.05)
> 0.01 to < 2.5 GHz	43 (50)	43 (50)	40 (43)	± 0.05 (± 0.03)	± 0.05 (± 0.02)
2.5 to 20 GHz	43 (50)	42 (50)	40 (43)	± 0.05 (± 0.03)	± 0.05 (± 0.03)
> 20 to 67 GHz	38 (44)	40 (44)	36 (42)	± 0.05 (± 0.03)	± 0.07 (± 0.05)
> 67 to 90 GHz	32 (38)	40 (44)	30 (36)	± 0.05 (± 0.03)	± 0.07 (± 0.05)
> 90 to 110 GHz	34 (38)	40 (43)	32 (36)	± 0.05 (± 0.03)	± 0.07 (± 0.05)

Measurement Uncertainties – SOLT/SSST with .s1p Standards Definitions

The graphs give measurement uncertainties after the above calibration. The errors are worst case contribution of residual directivity, load and source match, frequency response and isolation, network analyzer dynamic accuracy, and connector repeatability while noise effects are added on an RSS basis. 10 Hz IF Bandwidth is used. For transmission uncertainties, it is assumed that $S_{11} = S_{22} = 0$. For reflection uncertainties, it is assumed that $S_{21} = S_{12} = 0$. For other conditions, please use our free Exact Uncertainty calculator software, downloadable from the Anritsu web site at www.anritsu.com.

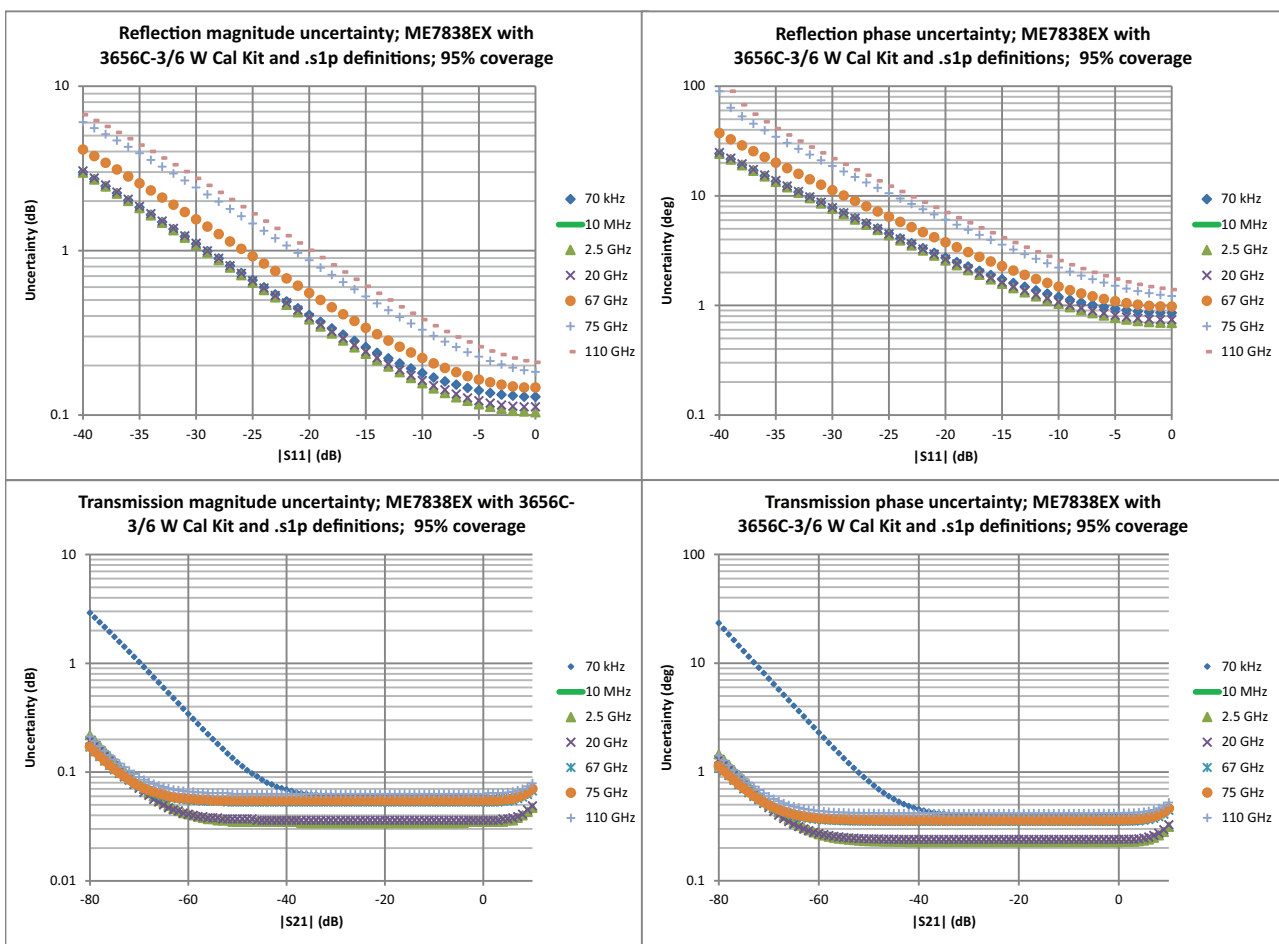

Corrected System Performance and Uncertainties – LRL/LRM

With 12-term LRL/LRM calibration using on-wafer substrate standards. Based on a typical vendor supplied impedance standard substrate. The calculation includes a term based on estimated probe coupling (assumed not corrected) and terms for typical probe loss and repeatability.

**ME7838EX
(Typical)**

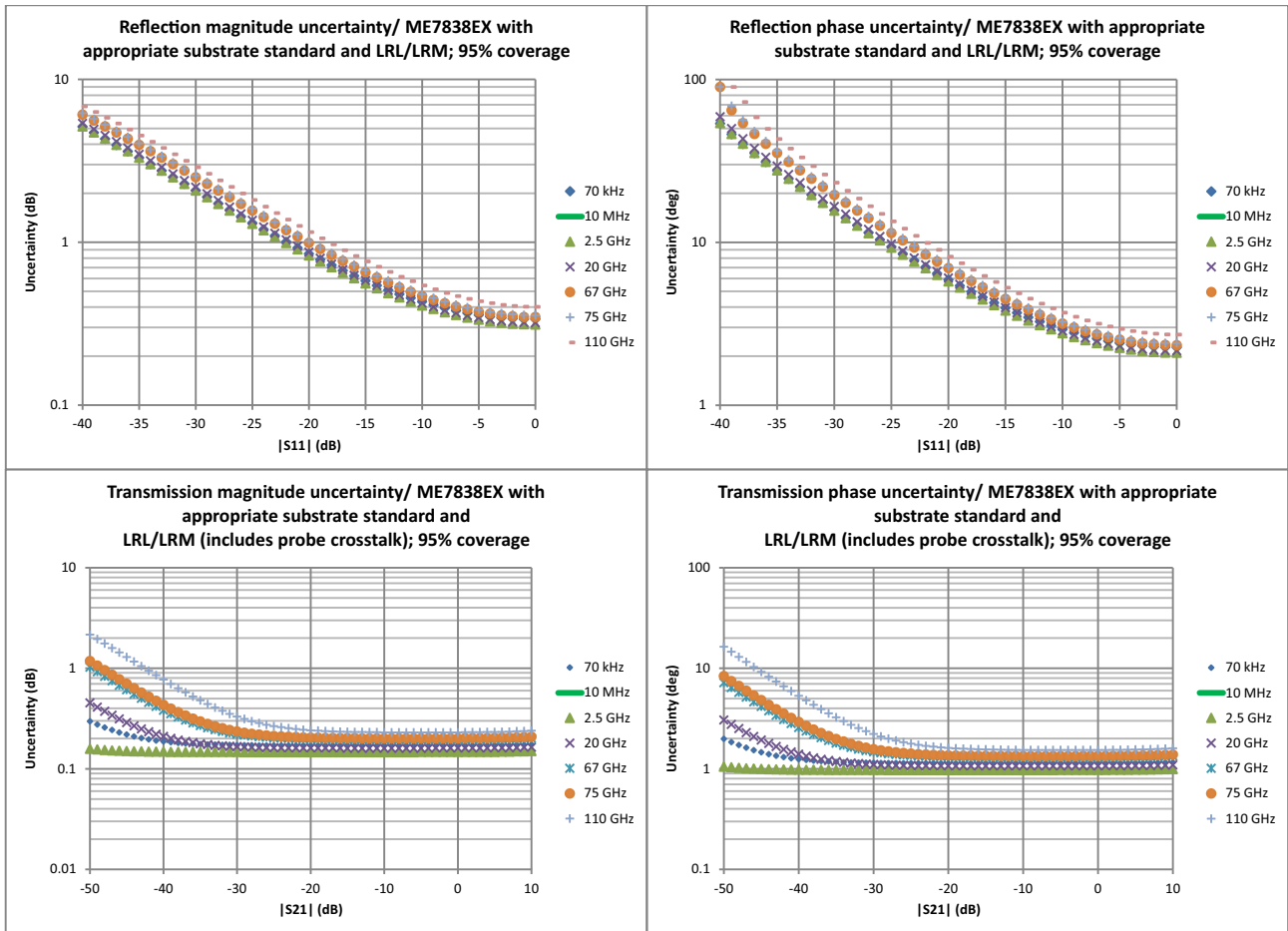

Broadband Measurement Examples

The following figures are measurement examples of typical ME7838EX Broadband system performance.

**ME7838EX
(Typical)**

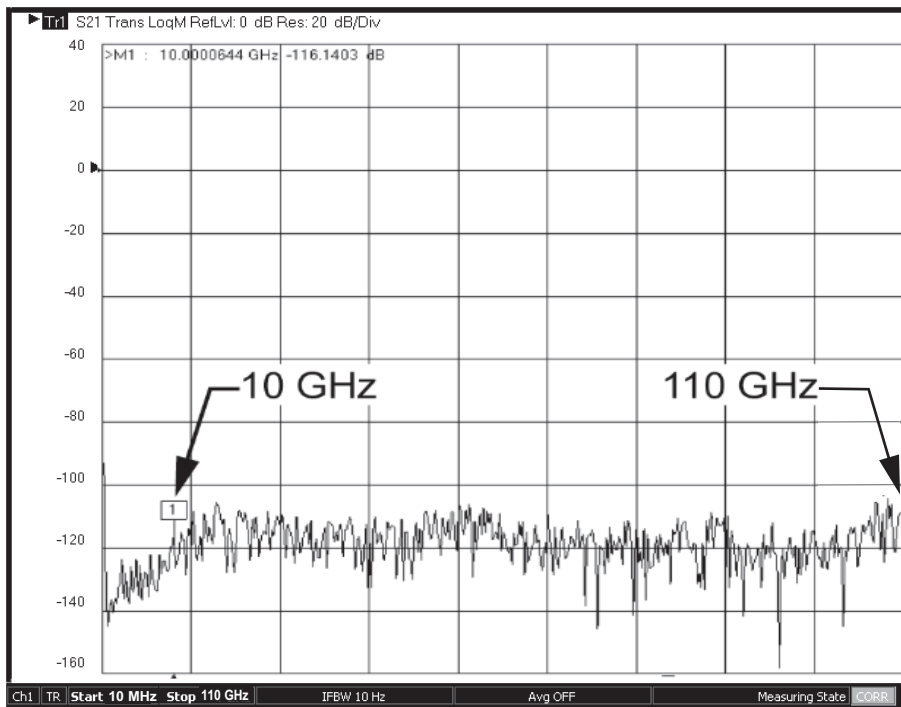

Typical dynamic range of ME7838EX system at the W1 1 mm coaxial test port from 70 kHz to 110 GHz.

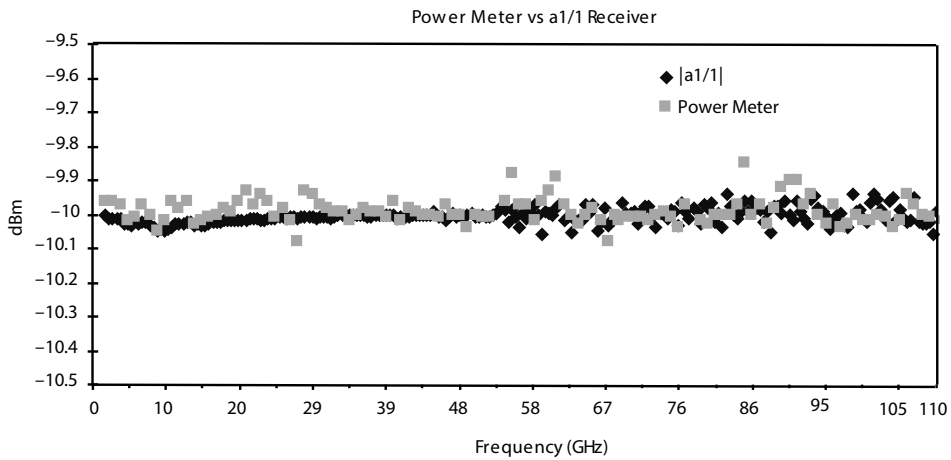

An example of typical power measurement agreement: power sensor vs. ME7838EX a1 reference receiver.

ME7838EX
(Typical)

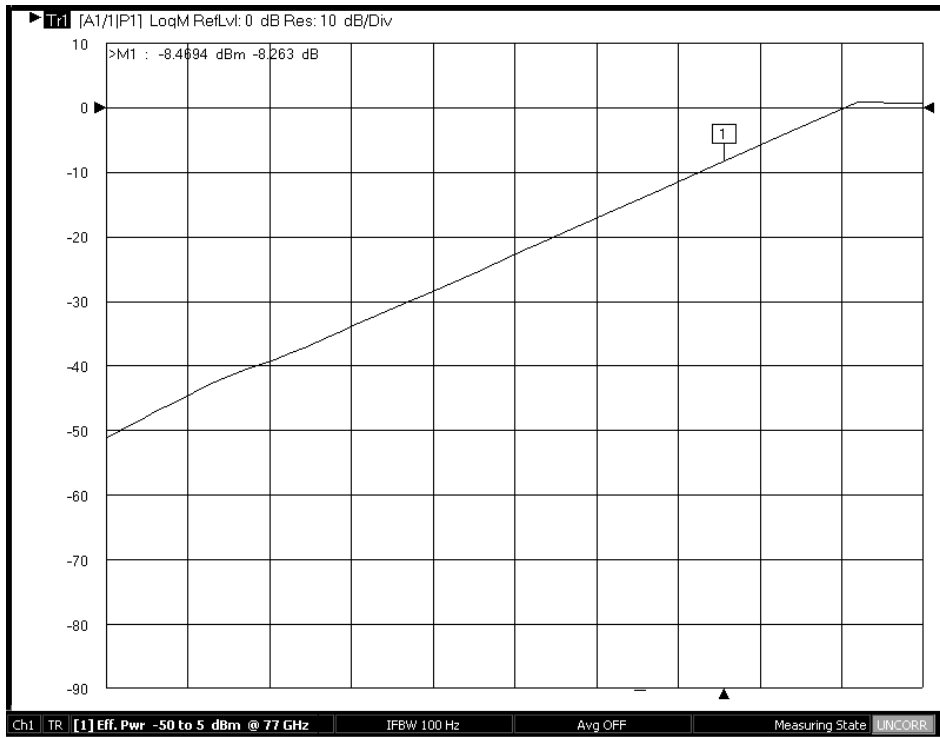

Typical power sweep range at 77 GHz. By using detection and power control inside the 3743EX millimeter-wave module; improved accuracy, linearity and range can be achieved.

Stability plots are obtained using simple normalization (except for those labeled vector-delta) in a controlled environment.

ME7838EX
(Typical)

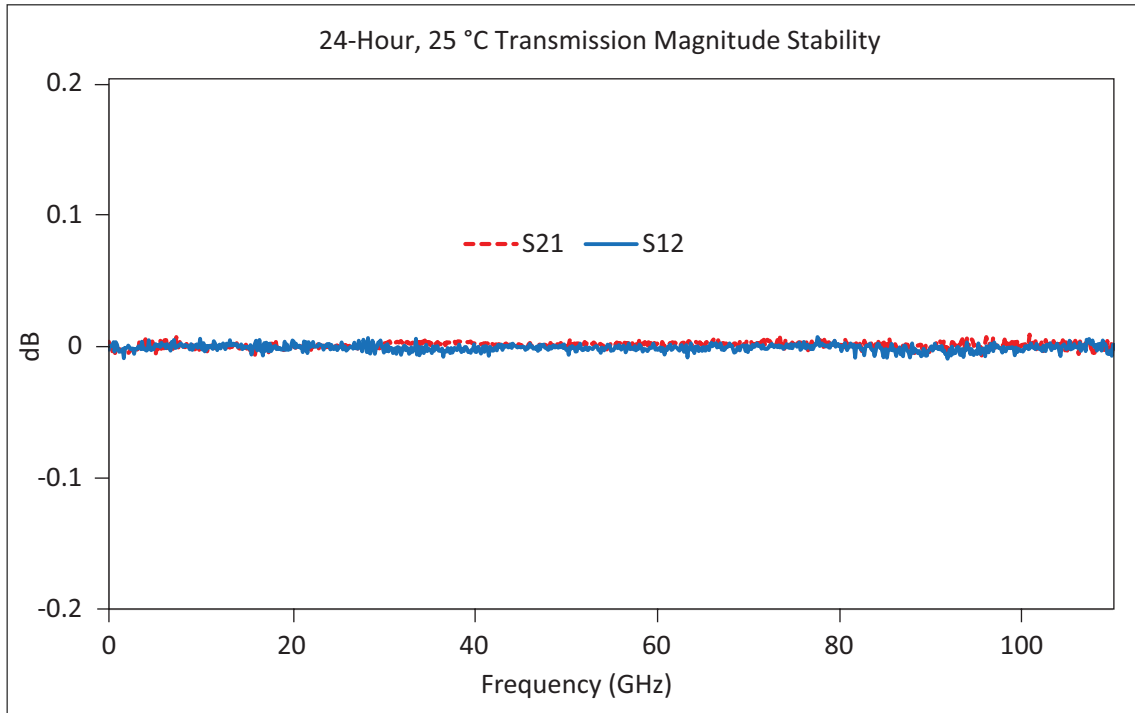

Typical 24-Hour Transmission Magnitude Stability

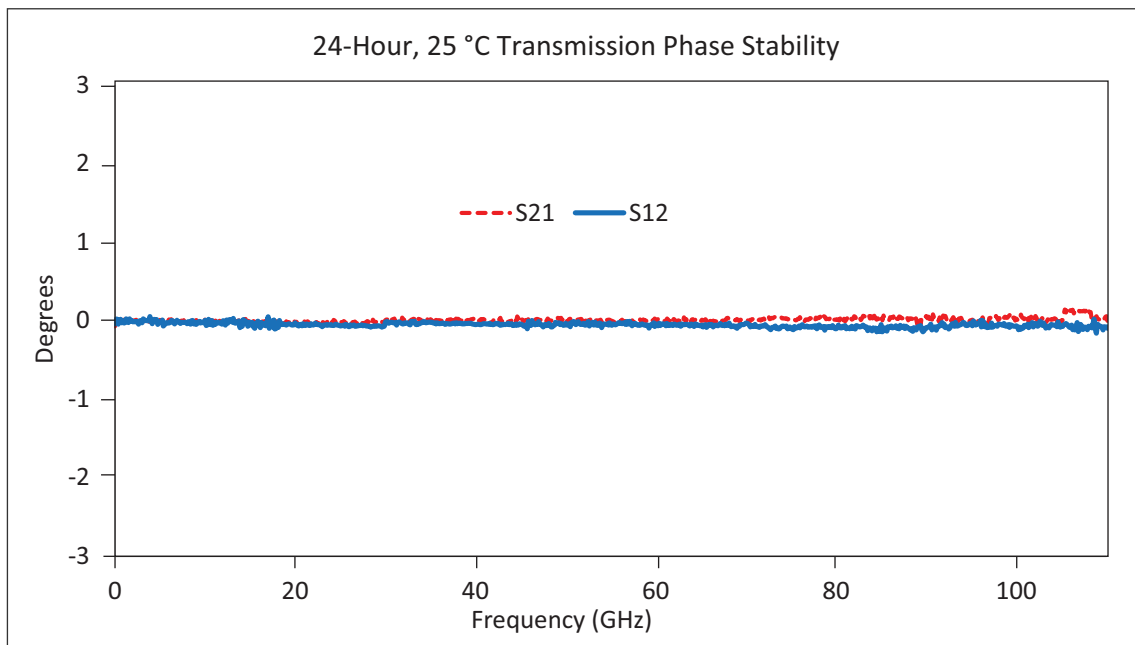

Typical 24-Hour Transmission Phase Stability

ME7838EX
(Typical)

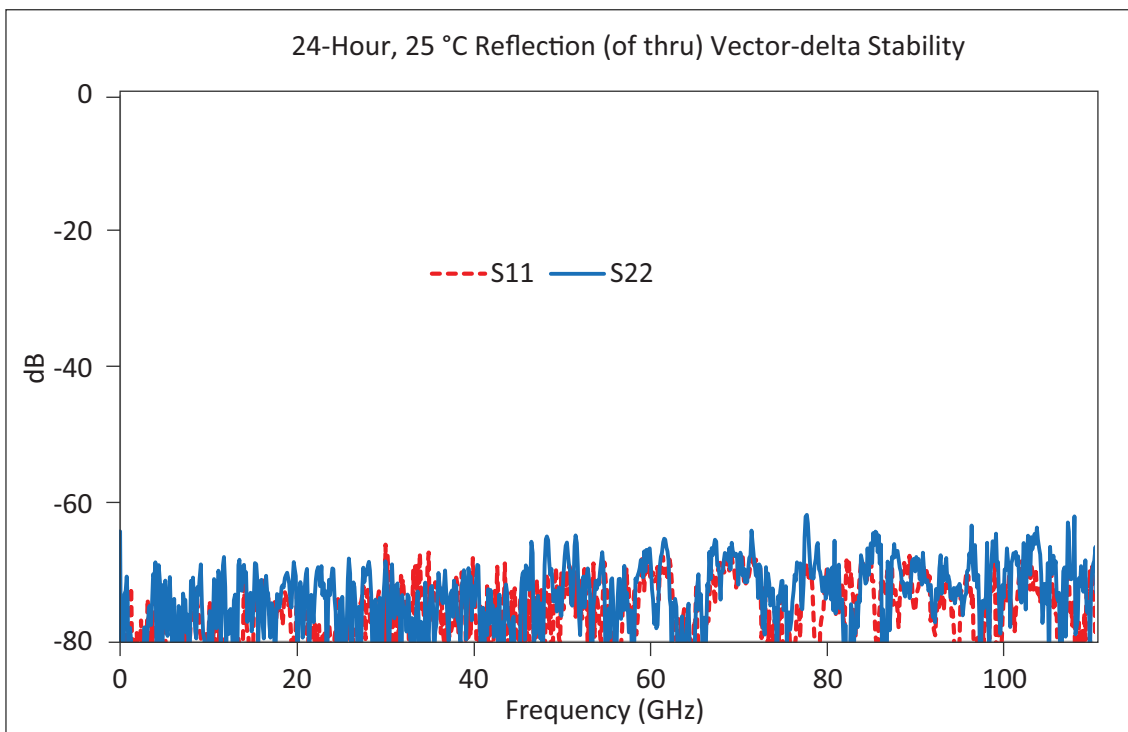

Typical 24-Hour Thru Line Match Vector-delta Stability

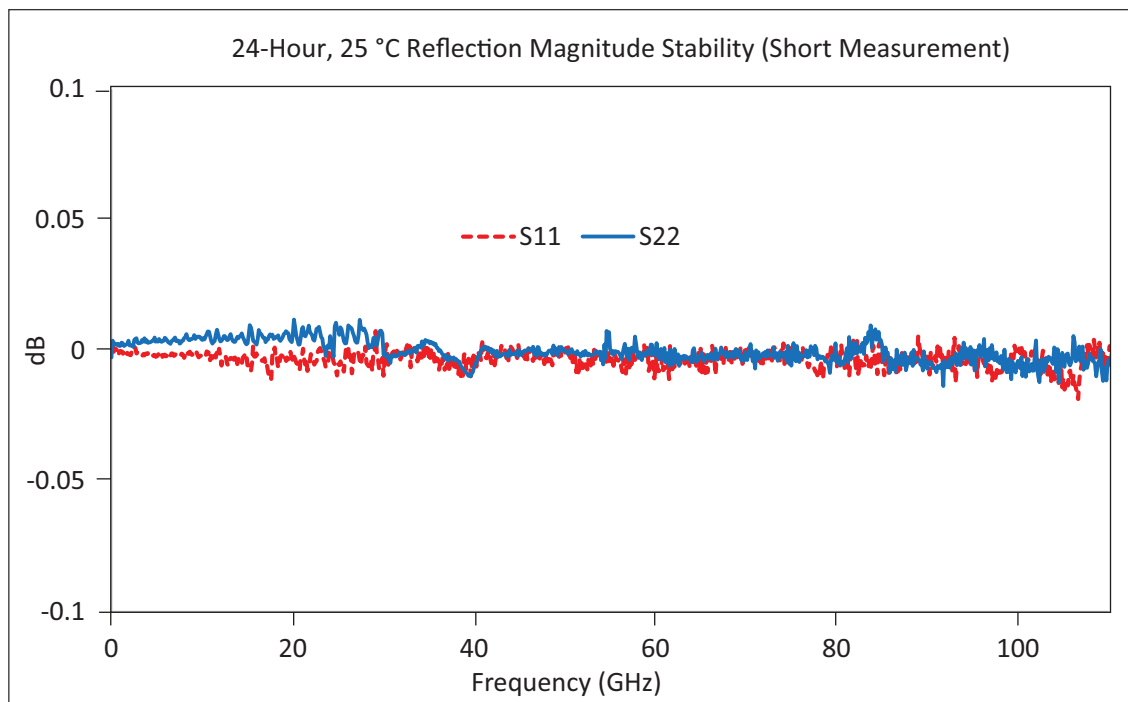

Typical 24-Hour Reflection Magnitude Stability

ME7838EX
(Typical)

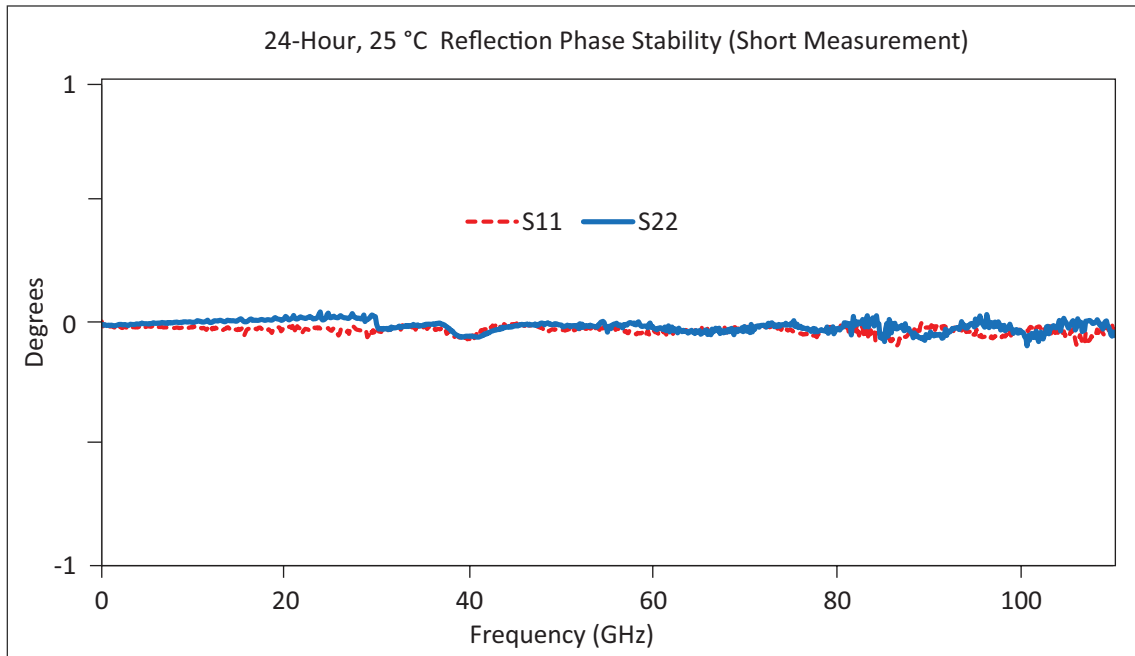

Typical 24-Hour Reflection Phase Stability

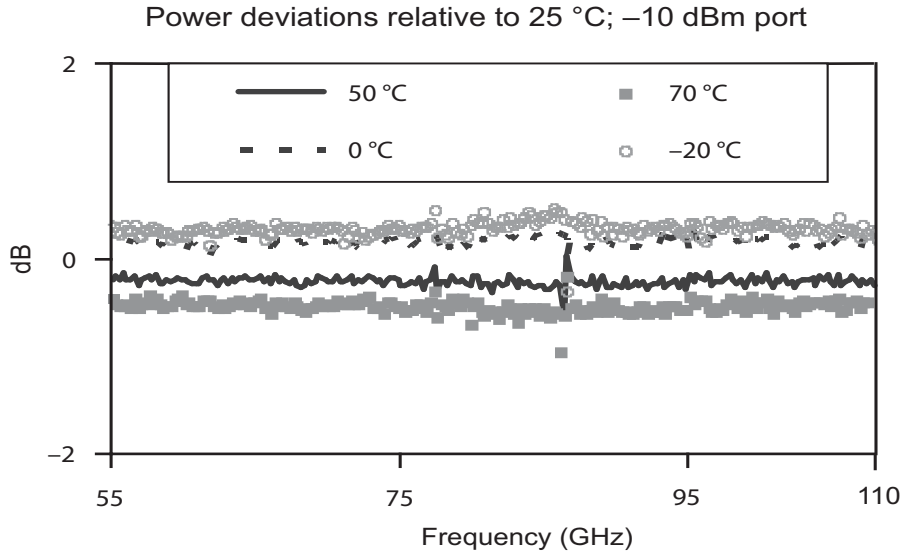

Typical power deviation with respect to wide temperature variation

ME7838E4X 4-Port VNA



ME7838E4X 4-Port VNA

ME7838E4X 4-port Broadband System

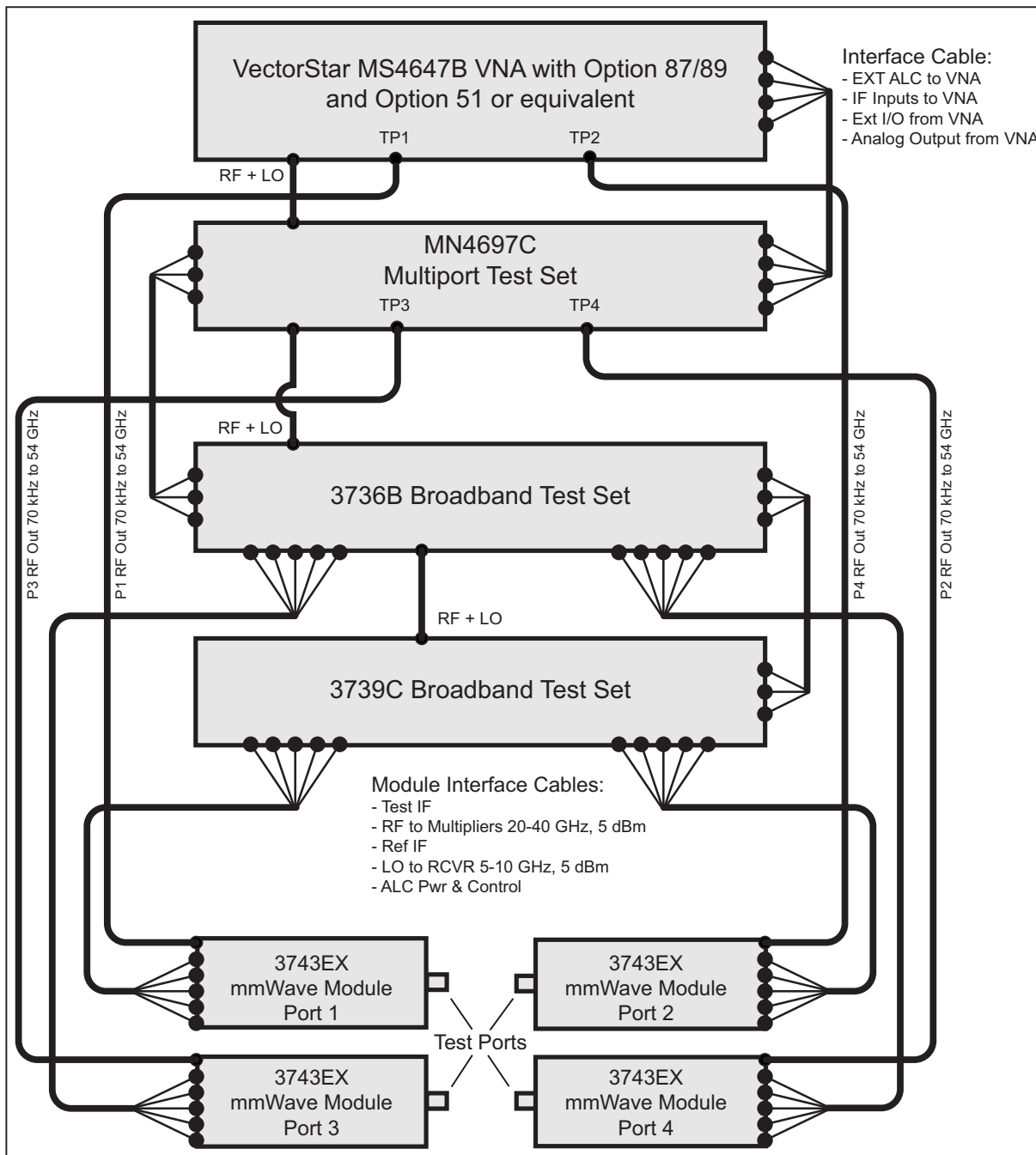

ME7838E4X 4-port Broadband System

ME7838E4X 4-port mmWave System

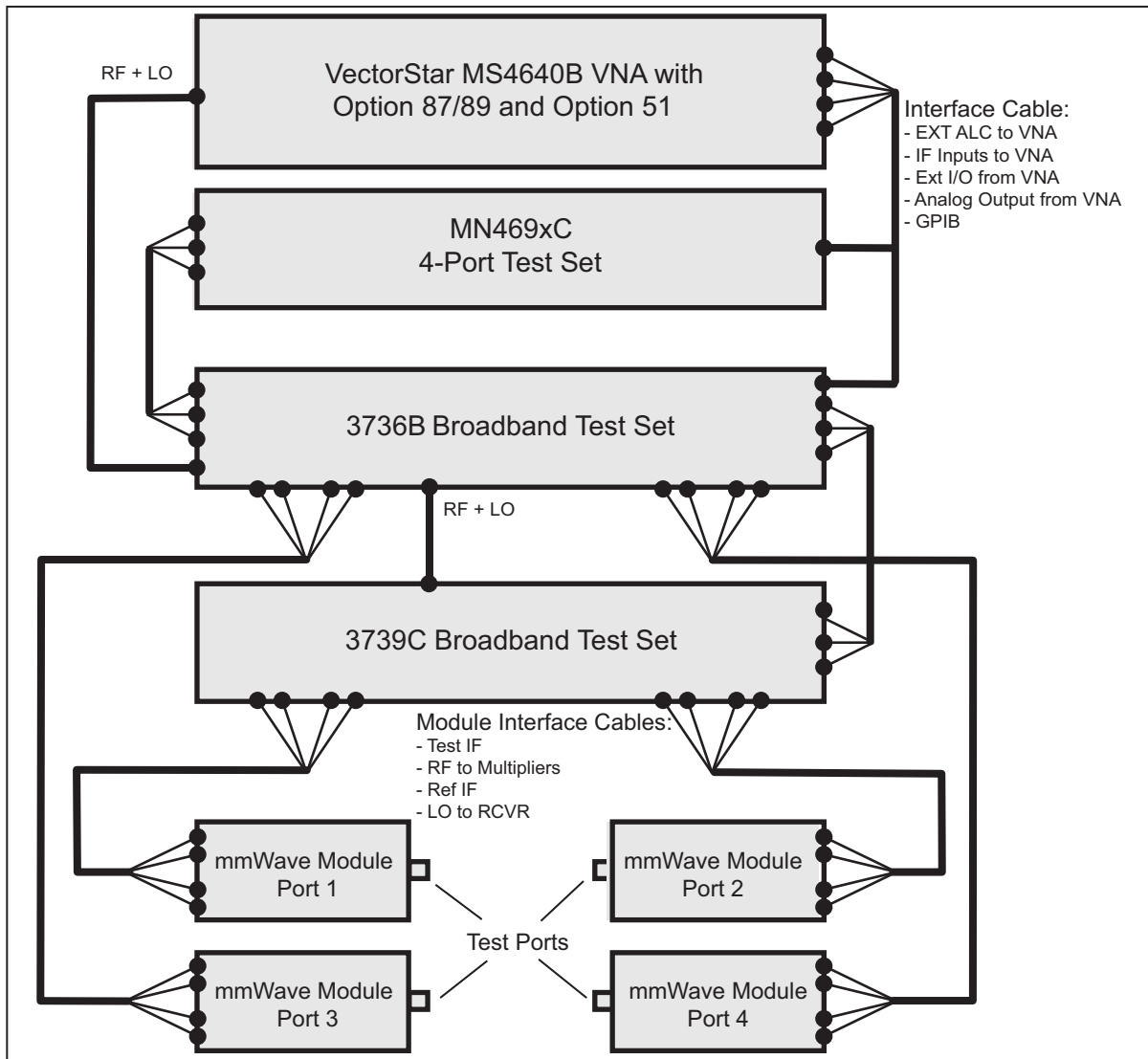

ME7838E4X 4-port mmWave System

Dynamic Range Specifications

System Dynamic Range (Excludes localized spurious responses and crosstalk)

System Dynamic Range	System dynamic range is measured as the difference between maximum port power and the RMS noise floor in a 10 Hz bandwidth and no averaging (ports terminated).
Normalizing Measurement	Normalizing measurement made with a through line connection, with its effects compensated for. The cables between the VNA and the 3743EX modules are assumed to be the 806-206-R 1.85 mm cable (61 cm, 24 in long) or the 806-209-R 1.85 mm cable (91.5 cm, 36 in long).

ME7838E4X^{a,b}

Specifications (Typical) [dB]

Frequency Range	Option 51	Option 61 or 62	Option 31	Option 31 and Option 61 or 62
70 to 300 kHz	82 (100)	82 (100)	84 (102)	84 (102)
> 0.3 to 2 MHz	92 (100)	92 (100)	94 (102)	94 (102)
> 2 to 10 MHz	100 (115)	100 (115)	102 (118)	102 (115)
> 0.01 to < 2.5 GHz	108 (120)	108 (120)	111 (124)	110 (120)
2.5 to 10 GHz	107 (116)	104 (112)	110 (118)	104 (114)
> 10 to 24 GHz	98 (112)	92 (101)	102 (113)	95 (105)
> 24 to 40 GHz ^c	95 (105)	90 (101)	100 (108)	95 (105)
> 40 to 54 GHz ^c	94 (104)	87 (96)	99 (108)	93 (104)
> 54 to 60 GHz	107 (116)	107 (116)	107 (116)	107 (116)
> 60 to 65 GHz	107 (116)	107 (116)	107 (116)	107 (116)
> 65 to 80 GHz	106 (116)	106 (116)	106 (116)	106 (116)
> 80 to 90 GHz	104 (110)	104 (110)	104 (110)	104 (110)
> 90 to 100 GHz	104 (110)	104 (110)	104 (110)	104 (110)
> 100 to 110 GHz	104 (110)	104 (110)	104 (110)	104 (110)

a. Option 51 is the minimum required option for 4-port baseband VNAs.

b. Table represents dynamic range with Ports 1 and/or 3 driving. With Port 2 driving, dynamic range may be up to 7 dB lower in the 2.5-54 GHz bands. With Port 4 driving, dynamic range may be up to 3 dB higher in the 2.5-54 GHz bands.

c. If Option 35 is installed, dynamic range is degraded by 3 dB.

Receiver Dynamic Range (Excludes localized spurious responses and crosstalk)

Receiver Dynamic Range is calculated as the difference between the receiver compression level and the noise floor at Ports 1 or 2.

ME7838E4X^a

Specifications (Typical) [dB]

Frequency Range	Option 51	Option 61 or 62	Option 31 and Option 51	Option 31 and Option 61 or 62
70 to 300 kHz	82 (96)	83 (96)	82 (95)	82 (95)
> 0.3 to 2 MHz	98 (102)	100 (103)	98 (101)	99 (102)
> 2 to 10 MHz	107 (117)	108 (118)	106 (117)	107 (115)
> 0.01 to < 2.5 GHz	115 (122)	117 (124)	115 (123)	117 (121)
2.5 to 10 GHz	122 (125)	122 (123)	124 (124)	121 (122)
> 10 to 24 GHz	117 (127)	115 (119)	120 (125)	116 (120)
> 24 to 40 GHz ^b	115 (119)	112 (117)	119 (120)	115 (119)
> 40 to 54 GHz ^b	121 (125)	117 (120)	122 (126)	118 (124)
> 54 to 60 GHz	119 (125)	119 (125)	119 (125)	119 (125)
> 60 to 65 GHz	119 (124)	119 (124)	119 (124)	119 (124)
> 65 to 70 GHz	122 (127)	122 (127)	122 (127)	122 (127)
> 70 to 80 GHz	120.5 (127)	120.5 (127)	120.5 (127)	120.5 (127)
> 80 to 90 GHz	120.5 (122)	120.5 (122)	120.5 (122)	120.5 (122)
> 90 to 100 GHz	116.5 (118)	116.5 (118)	116.5 (118)	116.5 (118)
> 100 to 110 GHz	120.5 (123)	120.5 (123)	120.5 (123)	120.5 (123)

a. Option 51 is required for 4-port baseband VNAs.

b. If Option 35 is installed, dynamic range is degraded by 3 dB.

Power Specifications

Maximum Power and Power Range tables represent powers available at Ports 1 and 3. Max Power may be up to 4 dB lower on Port 2 in the 2.5 GHz to 54 GHz bands. Max Power may be up to 3 dB higher on Port 4 in the 22.5 GHz to 54 GHz bands.

Maximum Power

Maximum port power is determined by the base VNA for frequencies below 54 GHz, and by the 3743EX mmWave module for frequencies greater than 54 GHz.

ME7838E4X^a
Specifications (Typical) [dB]

Frequency Range	Option 51	Option 61 or 62	Option 31 and Option 51	Option 31 and Option 61 or 62
70 to 300 kHz	6 (10)	5 (10)	8 (13)	8 (13)
> 0.3 to 2 MHz	6 (10)	5 (10)	8 (13)	8 (13)
> 2 to 10 MHz	5 (10)	5 (10)	8 (13)	8 (13)
> 0.01 to < 2.5 GHz	5 (10)	5 (10)	8 (13)	7 (13)
2.5 to 10 GHz	-3 (3)	-4 (3)	-2 (6)	-3 (6)
> 10 to 24 GHz	-7 (-3)	-9 (-4)	-6 (0)	-7 (-1)
> 24 to 40 GHz	-10 (-4)	-12 (-6)	-9 (-2)	-10 (-4)
> 40 to 54 GHz	-17 (-11)	-20 (-14)	-13 (-8)	-15 (-10)
> 54 to 60 GHz	-2 (1)	-2 (1)	-2 (1)	-2 (1)
> 60 to 65 GHz	-2 (2)	-2 (2)	-2 (2)	-2 (2)
> 65 to 70 GHz	-6 (-1)	-6 (-1)	-6 (-1)	-6 (-1)
> 70 to 80 GHz	-4.5 (-1)	-4.5 (-1)	-4.5 (-1)	-4.5 (-1)
> 80 to 90 GHz	-6.5 (-2)	-6.5 (-2)	-6.5 (-2)	-6.5 (-2)
> 90 to 100 GHz	-2.5 (2)	-2.5 (2)	-2.5 (2)	-2.5 (2)
> 100 to 110 GHz	-6.5 (-3)	-6.5 (-3)	-6.5 (-3)	-6.5 (-3)

a. Using the 806-206-R 1.85 mm (61 cm, 24 in long) test port cables between the VNA and the 3743EX mmWave modules.

Power Range

ME7838E4X
Specifications [dB]

Frequency Range	Option 51	Option 61 or 62	Option 31	Option 31 and Option 61 or 62
70 to 300 kHz	6 to -25	5 to -85	8 to -25	8 to -85
> 0.3 to 2 MHz	6 to -25	5 to -85	8 to -25	8 to -85
> 2 to 10 MHz	5 to -25	5 to -85	8 to -25	8 to -85
> 0.01 to < 2.5 GHz	5 to -25	5 to -85	8 to -25	7 to -85
2.5 to 10 GHz	-3 to -25	-4 to -85	-2 to -25	-3 to -85
> 10 to 24 GHz	-7 to -25	-9 to -85	-6 to -25	-7 to -85
> 24 to 40 GHz	-10 to -30	-12 to -90	-9 to -30	-10 to -90
> 40 to 54 GHz	-17 to -30	-20 to -90	-13 to -30	-15 to -90
> 54 to 60 GHz	-2 to -55	-2 to -55	-2 to -55	-2 to -55
> 60 to 65 GHz	-2 to -55	-2 to -55	-2 to -55	-2 to -55
> 65 to 70 GHz	-6 to -55	-6 to -55	-6 to -55	-6 to -55
> 70 to 80 GHz	-4.5 to -55	-4.5 to -55	-4.5 to -55	-4.5 to -55
> 80 to 90 GHz	-6.5 to -55	-6.5 to -55	-6.5 to -55	-6.5 to -55
> 90 to 100 GHz	-2.5 to -55	-2.5 to -55	-2.5 to -55	-2.5 to -55
> 100 to 110 GHz	-6.5 to -55	-6.5 to -55	-6.5 to -55	-6.5 to -55

Power Level Accuracy

Accuracy Defined at -20 dBm or max rated power, whichever is lower.

ME7838E4X**Specifications (Typical) [dB]**

Frequency Range	Accuracy	Resolution
70 to 300 kHz	(± 0.3)	0.01
> 0.3 to 2 MHz	(± 0.3)	0.01
> 2 to 10 MHz	(± 0.3)	0.01
> 0.01 to < 2.5 GHz	(± 0.4)	0.01
2.5 to 10 GHz	(± 0.5)	0.01
> 10 to 24 GHz	(± 0.5)	0.01
> 24 to 40 GHz	(± 0.9)	0.01
> 40 to 54 GHz	(± 0.9)	0.01
> 54 to 60 GHz	(± 1.3)	0.01
> 60 to 65 GHz	(± 1.3)	0.01
> 65 to 80 GHz	(± 1.3)	0.01
> 80 to 90 GHz	(± 1.7)	0.01
> 90 to 100 GHz	(± 2.3)	0.01
> 100 to 110 GHz	(± 2.3)	0.01

Receiver Compression

Receiver compression point is defined as the port power level beyond which the response may be compressed more than 0.2 dB relative to normalization level. 10 Hz IF bandwidth used to remove trace noise effects.

ME7838E4X^a**(Typical) [dBm]**

Frequency Range	Option 51	Option 61 or 62
70 to 300 kHz	(6)	(6)
> 0.3 to 2 MHz	(12)	(13)
> 2 to 10 MHz	(12)	(13)
> 0.01 to < 2.5 GHz	(12)	(14)
2.5 to 10 GHz	(12)	(14)
> 10 to 24 GHz	(12)	(14)
> 24 to 40 GHz	(10)	(10)
> 40 to 54 GHz	(10)	(10)
> 54 to 60 GHz	(10)	(10)
> 60 to 65 GHz	(10)	(10)
> 65 to 80 GHz	(10)	(10)
> 80 to 90 GHz	(10)	(10)
> 90 to 100 GHz	(10)	(10)
> 100 to 110 GHz	(10)	(10)

a. Using the 806-206-R 1.85 mm (61 cm, 24 in long) test port cables between the VNA and the 3743EX mmWave modules.

Trace Noise (High Level Noise)

Noise measured at 1 kHz IF bandwidth, at maximum power or compression limit (whichever is less), with through transmission. RMS.

ME7838E4X**Specifications (Typical)**

Frequency Range	Magnitude [dB]	Phase [deg.]
70 to 500 kHz	0.04 (0.02)	0.3 (0.07)
> 0.5 to 2 MHz	0.009 (0.005)	0.05 (0.025)
> 2 to 10 MHz	0.0055 (0.0035)	0.045 (0.025)
> 0.01 to < 2.5 GHz	0.0055 (0.0035)	0.055 (0.025)
2.5 to 10 GHz	0.0055 (0.0025)	0.055 (0.025)
10 TO 24 GHz	0.0055 (0.0025)	0.065 (0.025)
> 24 to 54 GHz	0.0055 (0.0025)	0.065 (0.03)
> 54 to 80 GHz	0.0045 (0.0025)	0.075 (0.04)
> 80 to 110 GHz	0.006 (0.0025)	0.105 (0.05)

Frequency Resolution, Accuracy, and Stability**ME7838E4X****Specifications**

Resolution	Accuracy	Stability
1 Hz	± 5 x 10 ⁻⁷ Hz/Hz (at time of calibration)	< 5 x 10 ⁻⁹ /°C over 0 °C to 50 °C temperature < 1 x 10 ⁻⁹ /day aging, instrument on

Noise Floor (Excludes localized spurious responses and crosstalk)

Noise floor is calculated as the difference between maximum rated port power and system dynamic range.

Normalizing measurement made with a through line connection, with its effects compensated for. The cables between the VNA and the 3743AX modules are assumed to be the 806-206-R 1.85 mm cable (61 cm, 24 in long) or the 806-209-R 1.85 mm cable (91.5 cm, 36 in long).

ME7838E4X
Specifications (Typical) [dB]

Frequency Range	Option 51	Option 61 or 62	Option 31 and Option 51	Option 31 and Option 61 or 62
70 to 300 kHz	-76 (-90)	-77 (-90)	-76 (-89)	-76 (-89)
> 0.3 to 2 MHz	-86 (-90)	-87 (-90)	-86 (-89)	-86 (-89)
> 2 to 10 MHz	-95 (-105)	-95 (-105)	-94 (-105)	-94 (-102)
> 0.01 to < 2.5 GHz	-103 (-110)	-103 (-110)	-103 (-111)	-103 (-107)
2.5 to 10 GHz	-110 (-113)	-108 (-109)	-112 (-112)	-107 (-108)
10 to 24 GHz	-105 (-115)	-100 (-105)	-108 (-113)	-102 (-106)
> 24 to 40 GHz ^a	-105 (-109)	-102 (-107)	-109 (-110)	-105 (-109)
> 40 to 54 GHz ^a	-111 (-115)	-107 (-110)	-112 (-116)	-108 (-114)
> 54 to 60 GHz	-109 (-115)	-109 (-115)	-109 (-115)	-109 (-115)
> 60 to 65 GHz	-109 (-114)	-109 (-114)	-109 (-114)	-109 (-114)
> 65 to 70 GHz	-112(-117)	-112(-117)	-112(-117)	-112(-117)
> 70 to 80 GHz	-110.5 (-117)	-110.5 (-117)	-110.5 (-117)	-110.5 (-117)
> 80 to 90 GHz	-110.5 (-112)	-110.5 (-112)	-110.5 (-112)	-110.5 (-112)
> 90 to 100 GHz	-106.5 (-108)	-106.5 (-108)	-106.5 (-108)	-106.5 (-108)
> 100 to 110 GHz	-110.5 (-113)	-110.5 (-113)	-110.5 (-113)	-110.5 (-113)

a. If Option 35 is installed, noise floor is degraded by 3 dB.

Source Phase Noise and Harmonics

Measured at default power.

ME7838E4X
(Typical)

Frequency Range	1 KHz Offset [dB/Hz]	10 kHz Offset [dB/Hz]	100 kHz Offset ^a [dB/Hz]	2nd Harmonic [dBc]	3rd Harmonic [dBc]
70 kHz to 0.01 GHz	(-86)	(-83)	(-88)	(-25)	(-30)
> 0.01 to < 2.5 GHz	(-90)	(-92)	(-96)	(-35)	(-35)
> 2.5 to 5 GHz	(-93)	(-94)	(-95)	(-35)	(-45)
> 5 to 10 GHz	(-86)	(-90)	(-90)	(-35)	(-45)
> 10 to 20 GHz	(-81)	(-84)	(-84)	(-40)	(-45)
> 20 to 26.5GHz	(-78)	(-81)	(-81)	(-30)	(-45)
> 26.5 to 40 GHz	(-72)	(-76)	(-78)	(-45)	(-45)
> 40 to 54 GHz	(-69)	(-73)	(-74)	(-45)	-
> 54 to 80 GHz	(-66)	(-70)	(-71)	(-40)	-
> 80 to 110 GHz	(-62)	(-66)	(-68)	-	-

a. Only applies for source frequencies > 300 kHz.

Uncorrected (Raw) Port Characteristics

ME7838E4X
(Typical)

Frequency	Directivity [dB]	Port Match [dB]
70 kHz to 0.01 GHz	(10 ^a)	(8)
> 0.01 to < 2.5 GHz	(9 ^a)	(10)
2.5 to 30 GHz	(5 ^a)	(12)
> 30 to 40 GHz	(5 ^a)	(5)
> 40 to 54 GHz	(10)	(5)
> 54 to 80 GHz	(10)	(10)
> 80 to 110 GHz	(5)	(7)

a. Raw directivity is degraded below 300 kHz, 2.2 to 2.5 GHz and in narrow bands within 10 to 34 GHz.

Measurement Time Measurement times include sweep time, retrace time, and band-switching time.
Full Band, 70 kHz to 110 GHz, Display ON, and ALC ON.

**ME7838E4X
(Typical) [ms]**

1 Port Cal IFBW	401 Points	1601 Points	10001 Points	25000 Points
1 MHz	(210)	(270)	(780)	(1,380)
30 kHz	(250)	(320)	(1,180)	(2,980)
10 kHz	(265)	(430)	(1,930)	(4,380)
1 kHz	(530)	(1,680)	(11,000)	(27,000)
10 Hz	(48,000)	(160,000)	(1,000,000)	(2,500,000)

2 Port Cal IFBW^a	401 Points	1601 Points	10001 Points	25000 Points
1 MHz	(420)	(540)	(1,560)	(2,760)
30 kHz	(500)	(640)	(2,360)	(5,960)
10 kHz	(530)	(860)	(3,860)	(8,760)
1 kHz	(1,060)	(3,360)	(22,000)	(54,000)
10 Hz	(96,000)	(320,000)	(2,000,000)	(5,000,000)

a. Times for only those parameters in the calibration. Times are double for 1-2 calibrations and 3-4 calibrations.

Measurement Time vs. System Dynamic Range

Full Band, Display ON, and ALC ON.

**ME7838E4X
(Typical)**

Calibration	401 Points Measurement Time [ms]	Achieved System Dynamic Range (Opt 62 at 54 GHz) [dB]	IFBW and Averaging Used
Uncorrected or 1-port calibration	(285)	(77)	(10 kHz/no avg)
	(550)	(87)	(1 kHz/no avg)
2-port calibration ^a	(570)	(77)	(10 kHz/no avg)
	(1100)	(87)	(1 kHz/no avg)

a. 2-port calibration (excluding 1-2 and 3-4).

Corrected System Performance and Uncertainties

Corrected System Performance and Uncertainties – SOLT/SSST

With 12-term broadband calibration (concatenated SOLT and Triple Offset Short Calibration (SSST)), using the 3656C W1 Calibration Kit and .ccf component definitions. Cable flexure and drift effects are not included.

ME7838E4X
(Typical) [dB]

Frequency	Directivity	Source Match	Load Match	Reflection Tracking	Transmission Tracking
70 kHz to 10 MHz	40 (46)	40 (46)	38 (44)	± 0.10 (± 0.05)	± 0.10 (± 0.05)
> 0.01 to < 2.5 GHz	40 (46)	40 (46)	38 (44)	± 0.05 (± 0.03)	± 0.05 (± 0.03)
2.5 to 20 GHz	40 (44)	40 (46)	38 (44)	± 0.05 (± 0.03)	± 0.05 (± 0.03)
> 20 to 40 GHz	36 (40)	38 (44)	33 (38)	± 0.05 (± 0.03)	± 0.07 (± 0.05)
> 40 to 67 GHz	30 (37)	37 (42)	27 (35)	± 0.05 (± 0.03)	± 0.07 (± 0.05)
> 67 to 90 GHz	30 (38)	34 (40)	30 (36)	± 0.07 (± 0.05)	± 0.07 (± 0.05)

Measurement Uncertainties – SOLT/SSST

The graphs give measurement uncertainties after the above calibration. The errors are worst case contribution of residual directivity, load and source match, frequency response and isolation, network analyzer dynamic accuracy, and connector repeatability while noise effects are added on an RSS basis. 10 Hz IF Bandwidth is used. For transmission uncertainties, it is assumed that $S_{11} = S_{22} = 0$. For reflection uncertainties, it is assumed that $S_{21} = S_{12} = 0$. For other conditions, please use our free Exact Uncertainty calculator software, downloadable from the Anritsu web site at, www.anritsu.com.

NOTE Although the graph axes show specific S-parameters, they apply to all transmission or reflection parameters, as appropriate.

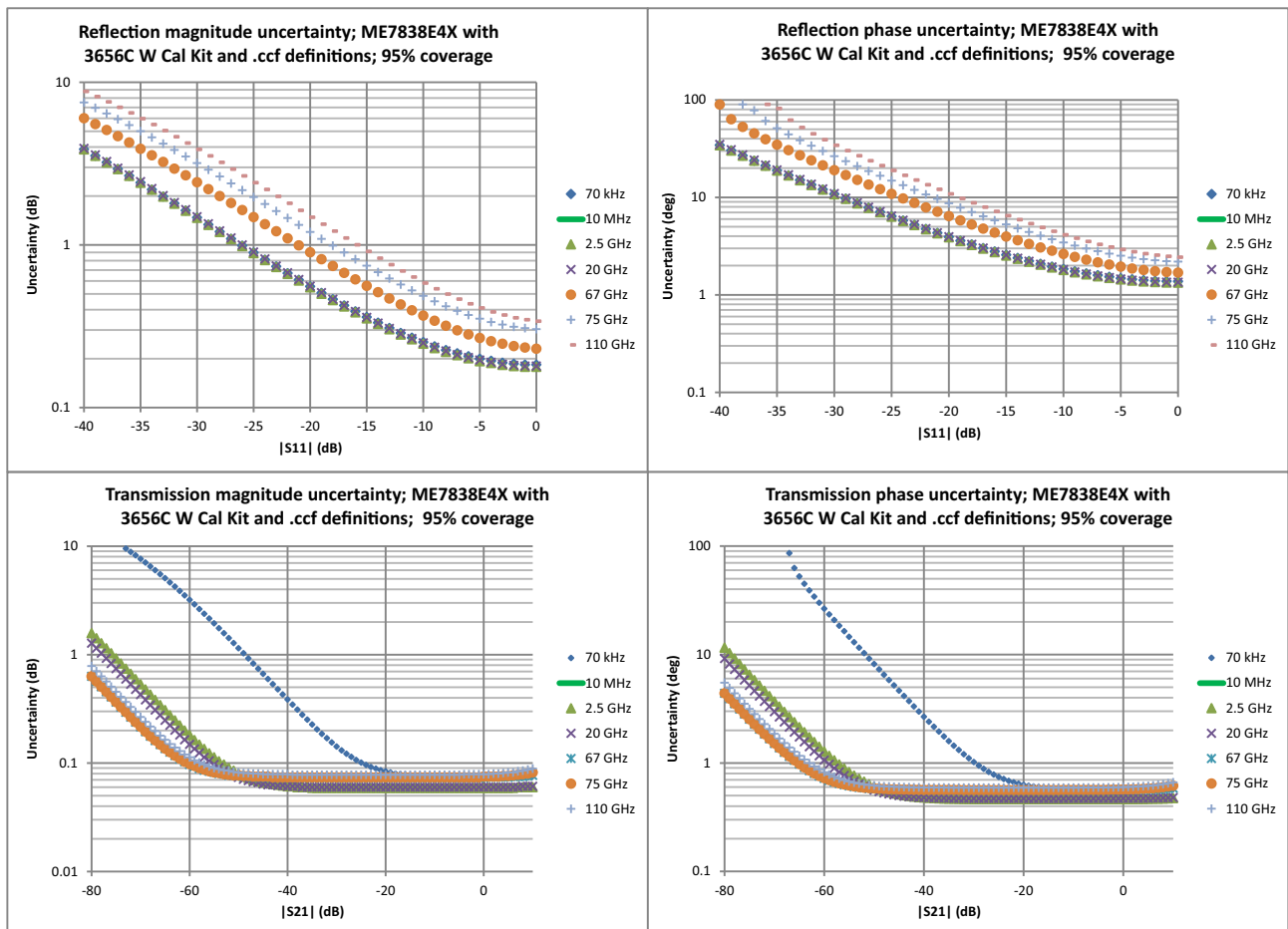

Corrected System Performance and Uncertainties – SOLT/SSST with .s1p Standards Definitions

With 12-term broadband calibration (concatenated SOLT and Triple Offset Short Calibration (SSST)), using the 3656C-3 or -6 W1 Calibration Kit and .s1p component definitions. Cable flexure and drift effects are not included.

**ME7838E4X
Specification (Typical) [dB]**

Frequency Range	Directivity	Source Match	Load Match	Reflection Tracking	Transmission Tracking
70 kHz to 10 MHz	43 (50)	43 (50)	40 (47)	± 0.1 (± 0.05)	± 0.1 (± 0.05)
> 0.01 to 2.5 < GHz	43 (50)	43 (50)	40 (47)	± 0.05 (± 0.03)	± 0.05 (± 0.02)
2.5 to 20 GHz	43 (50)	42 (50)	40 (47)	± 0.05 (± 0.03)	± 0.05 (± 0.03)
> 20 to 67 GHz	38 (44)	40 (44)	36 (42)	± 0.05 (± 0.03)	± 0.07 (± 0.05)
> 67 to 95 GHz	32 (38)	40 (44)	30 (36)	± 0.05 (± 0.03)	± 0.07 (± 0.05)
> 95 to 110 GHz	34 (38)	40 (44)	32 (36)	± 0.05 (± 0.03)	± 0.07 (± 0.05)

Measurement Uncertainties – SOLT/SSST with .s1p Standards Definitions

The graphs give measurement uncertainties after the above calibration. The errors are worst case contribution of residual directivity, load and source match, frequency response and isolation, network analyzer dynamic accuracy, and connector repeatability while noise effects are added on an RSS basis. 10 Hz IF Bandwidth is used. For transmission uncertainties, it is assumed that $S_{11} = S_{22} = 0$. For reflection uncertainties, it is assumed that $S_{21} = S_{12} = 0$. For other conditions, please use our free Exact Uncertainty calculator software, downloadable from the Anritsu web site at, www.anritsu.com.

NOTE Although the graph axes show specific S-parameters, they apply to all transmission or reflection parameters, as appropriate.

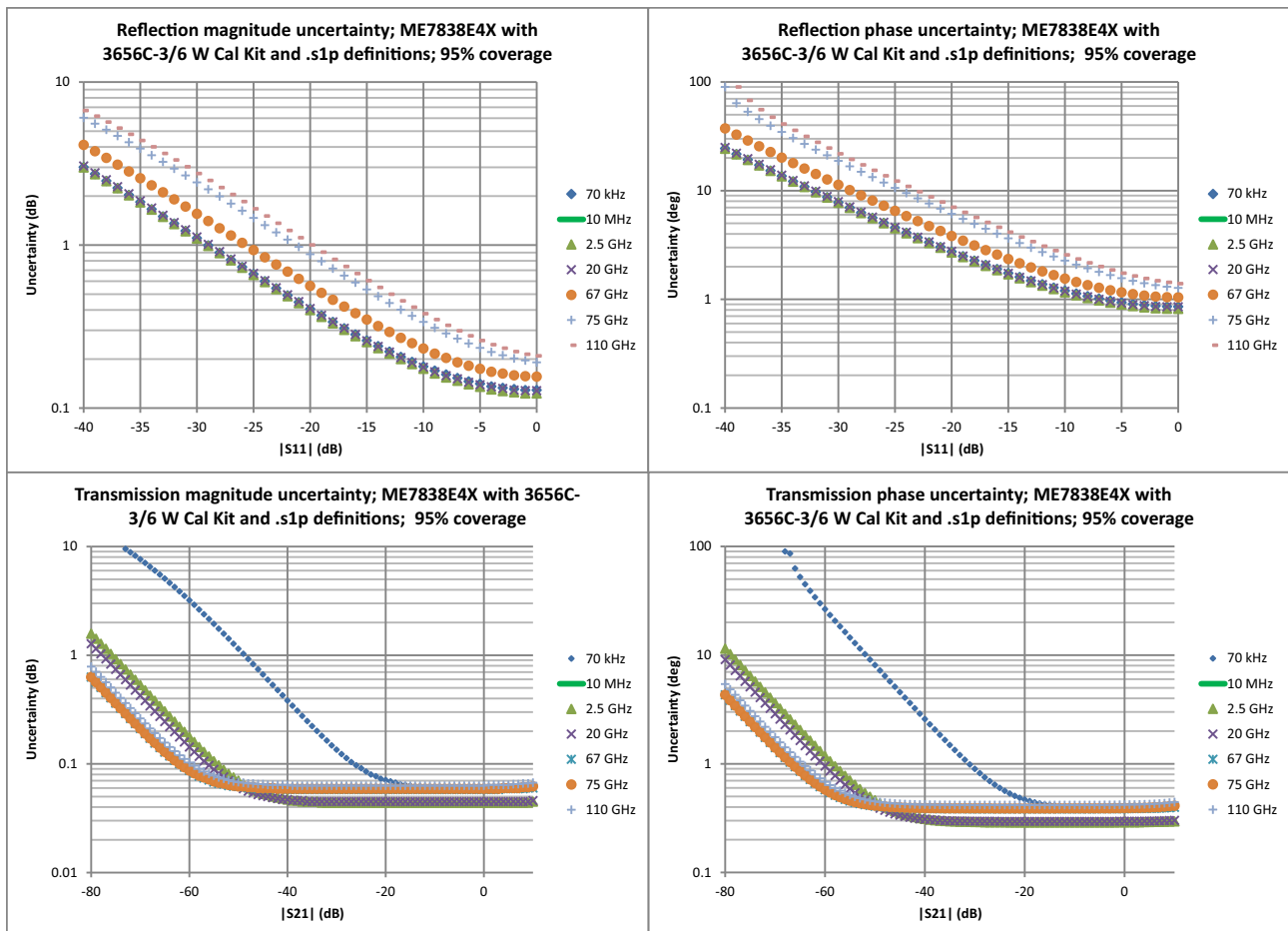

Corrected System Performance and Uncertainties – LRL/LRM

With 12-term LRL/LRM calibration using single-ended probes and on-wafer substrate standards. Based on a typical vendor supplied impedance standard substrate. The calculation includes a term based on estimated probe coupling (assumed not corrected) and terms for typical probe loss and repeatability.

**ME7838E4X
(Typical)**

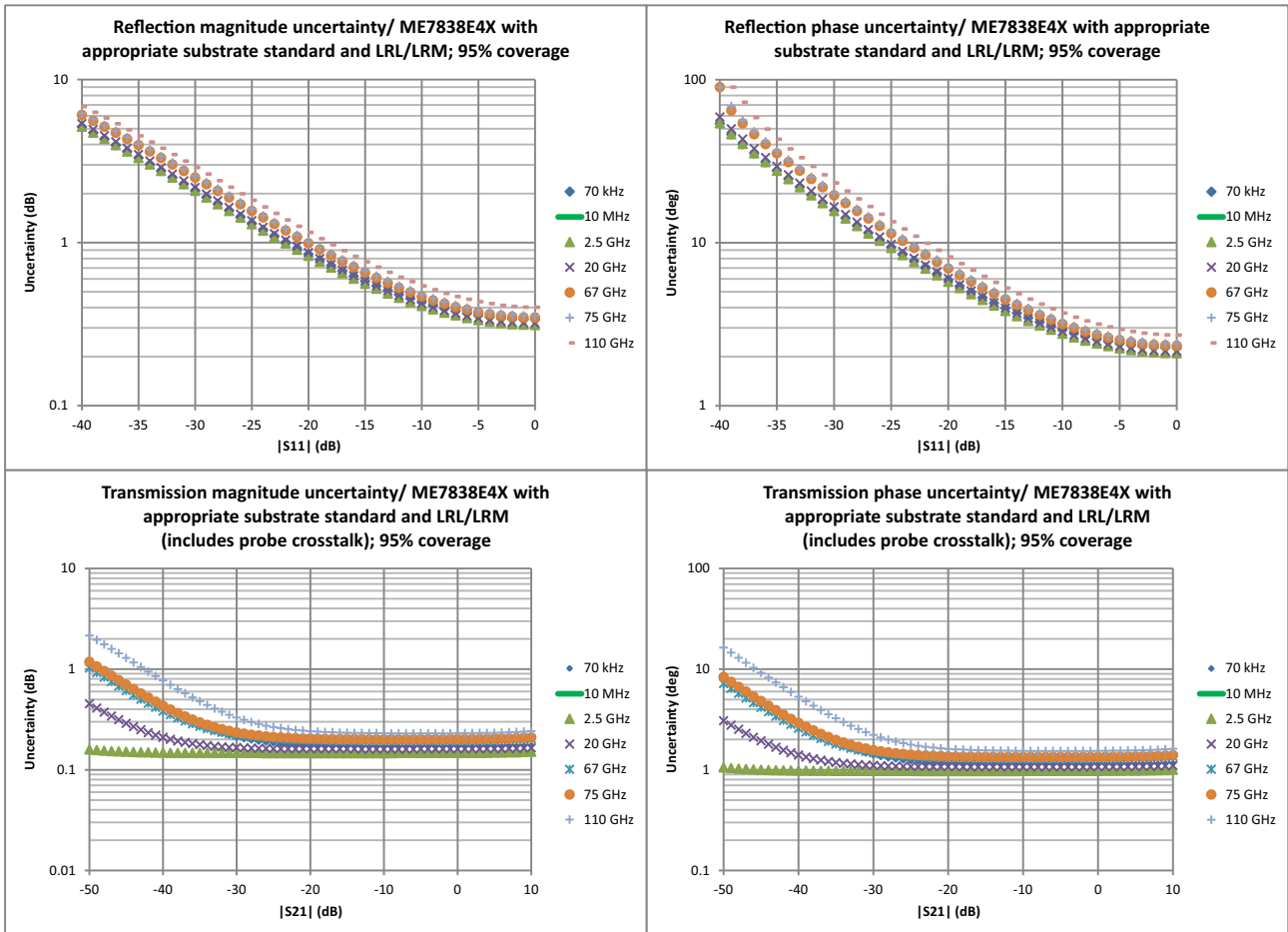

Measurement Examples

The following figures are measurement examples of typical ME7838E4X Broadband system performance. Simple normalization used for these stability measurements.

ME7838E4X

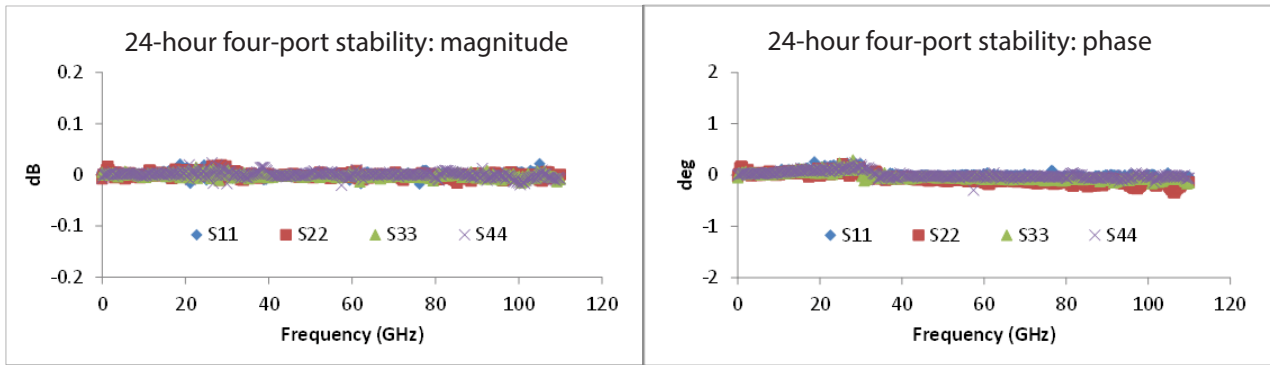

ME7838E4X 4-port typical Broadband Reflection Magnitude and Phase Stability with temperature held constant (25 °C).

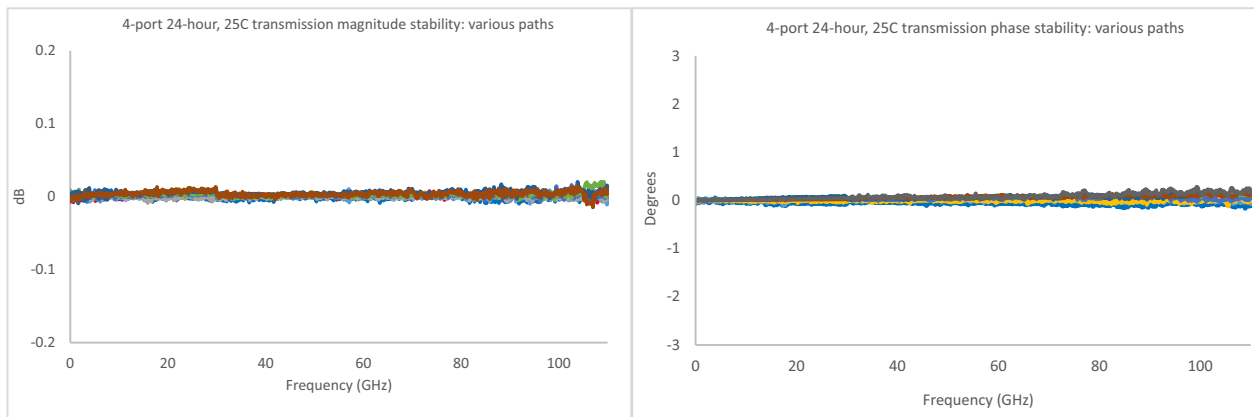

ME7838E4X 4-port typical broadband transmission stability over 24 hours with temperature held constant (25 °C). Measurements of thru lines on a sampling of the possible two-port paths are represented.

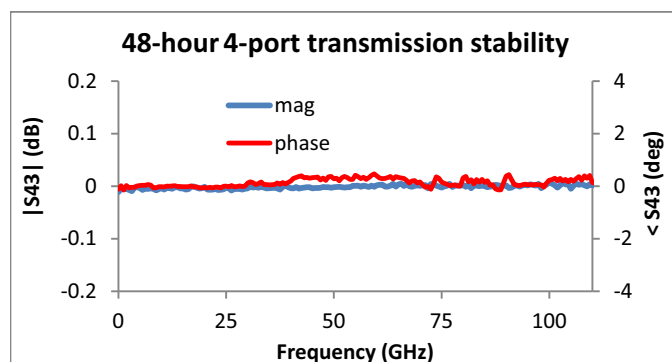

ME7838E4X 4-Port Typical Transmission Stability over 48 hours and 6 °C Temperature swing.

Components Accessories



Accessories

SC8215 and SC7287 Kelvin Bias Tees

Provides Sense and Force SMC connections close to the mmWave module to minimize the IR drops associated with the impedances between the bias tee and the DUT.

Part Number	Description	Voltage	Current
SC8215	The SC8215 is a V-connectorized bias tee usable with the mmWave modules in the ME7838EX for system frequencies of 70 kHz to 110 GHz. Stand-alone, it is usable to 70 GHz.	Max Voltage: 16 VDC	Max Current: 100 mA
SC7287	The SC7287 is a V-connectorized bias tee usable with the mmWave modules in the ME7838EX for system frequencies of 100 MHz to 110 GHz. Stand-alone, it is usable to 70 GHz.	Max Voltage: 50 VDC	Max Current: 500 mA
Tri-Axial Output SMU	For applications requiring Source Measure Units (SMU) with tri-axial outputs, a tri-axial (male) to SMC (male) cable is available, with the inner-shield isolated from ground at the bias tee SMC end, to float at the SMU guard potential. Check the accessories list for ordering information on page 57 .		

Waveguide Band Configuration

ME7838EX Millimeter-Wave VNA, Waveguide Bands

Three configurations are available for waveguide band operation for E and W bands when using the ME7838EX system.

- 3743EX Module First, the Anritsu 3743EX Broadband mmWave module can be adapted to waveguide measurements using waveguide adapters.
- mmWave Modules Second, the Anritsu 3744E-EE or 3744E-EW millimeter-wave module can be used. These version modules operate in the extended E and W waveguide bands and are operational using the MS4644B, or MS4647B VectorStar (with Options 86/87/88/89 and Option 7) and the 3739C broadband/millimeter-wave test set.
- E and W Band mmWave Modules The third configuration is to use external E and W band millimeter-wave modules with any model VectorStar (with Options 86/87/88/89 and Option 7) and the 3739C test set. The ME7838EX system may also be configured for the above W band mmWave operation. With the addition of VDI modules, operation up to 1.1 THz can be achieved.

E and W Band Operation Using the 3743EX, 3744E-EE, or 3744E-EW mmWave Module



3743EX Millimeter-Wave Modules



3744E-EE/3744E-EW Millimeter-Wave Module with Waveguide Adapter

The 3743EX Broadband mmWave module can be adapted to a waveguide band output by adding an available waveguide band adapter and mounting flange. VectorStar menus automatically configure the system frequencies incorporating the 3743EX module for banded operation. Using the 3743EX modules provides the opportunity to sweep frequencies for broadband applications and quickly convert to waveguide configurations for banded measurements. The advantages of small compact modules with excellent RF performance and power range control can therefore be realized in both broadband and waveguide configurations when using the 3743EX mmWave module. For systems where only waveguide band operation is required, the 3744E-EE or 3744E-EW mmWave module can be used.

The 3744E-EE or 3744E-EW mmWave module operates from 54 GHz to 110 GHz. The band supported is determined by the waveguide adapter connected to the 1 mm test port output of the 3744E-EE/EW module:

- 3744E-EE Configures the module for Extended E Band
- 3744E-EW Configures for Extended W Band

The RF input port of the 3744E-EE or 3744E-EW module is restricted below 54 GHz, however, the RF input port retains a DC connection to the 1 mm test port. Thus, the waveguide adapter can be removed for on-wafer applications from 54 GHz to 110 GHz operation and the on-wafer DUT can be biased through the RF input port.

Band	Frequency Range	Waveguide Flange	Transmission/Reflection Module
Ext-E	56 to 94 GHz ^a	WR-12	3744E-EE
Ext-W	65 to 110 GHz	WR-10	3744E-EW

a. Operational to 95 GHz.

Waveguide Band Specifications

Port Power, Noise Floor, Dynamic Range – 3744E-EE/3744E-EW mmWave Modules

System dynamic range is defined as the ratio of the source power to the noise floor. Maximum Receiver Power is defined as the 0.2 dB compression point of the receiver at the waveguide port. Receiver dynamic range is defined as the ratio of maximum receive power to the noise floor. Noise Floor measurements are RMS, are made with no average in a 10 Hz IF bandwidth, and include an isolation calibration.

3744E-EE Extended-E Band (WR-12) Waveguide

(Typical)

Frequency Range [GHz]	Source Power [dBm]	Max. Receive Power (0.2 dB comp. pt.) [dBm]	Noise Floor [dBm]	System Dynamic Range [dB]	Receiver Dynamic Range [dB]
56 to 60	(-2)	(11)	(-111)	(109)	(122)
> 60 to 65	(0)	(11)	(-106)	(106)	(117)
> 65 to 80	(-3)	(11)	(-109)	(106)	(120)
> 80 to 85	(-4)	(11)	(-112)	(108)	(123)
> 85 to 90	(-4)	(11)	(-110)	(106)	(121)
> 90 to 94 ^a	(0)	(12)	(-105)	(105)	(117)

a. Operational to 95 GHz.

3744E-EW Extended-W Band (WR-10) Waveguide

(Typical)

Frequency Range [GHz]	Source Power [dBm]	Max. Receive Power (0.2 dB comp. pt.) [dBm]	Noise Floor [dBm]	System Dynamic Range [dB]	Receiver Dynamic Range [dB]
65 to 67	(0)	(11)	(-106)	(106)	(117)
> 67 to 80	(-3)	(11)	(-109)	(106)	(120)
> 80 to 85	(-4)	(11)	(-112)	(108)	(123)
> 85 to 90	(-4)	(11)	(-110)	(106)	(121)
> 90 to 100	(0)	(12)	(-105)	(105)	(117)
> 100 to 110	(-5)	(12)	(-110)	(105)	(122)

Power Range, Accuracy, Linearity, and Resolution

Accuracy is defined at -10 dBm or max rated power, whichever is lower. Linearity is defined as the incremental error between the accuracy test power level and 5 dB below.

Specifications (Typical)

Frequency Range [GHz]	Range [dBm]		Accuracy [dB]	Linearity [dB]	Resolution [dB]
	ME7838EX	ME7838EX Option 62			
54 to 60	(-55 to -2)	(-55 to -2)	(± 2.0)	(± 1.5)	0.01
> 60 to 65	(-55 to 0)	(-55 to 0)	(± 2.0)	(± 1.5)	0.01
> 65 to 80	(-55 to -3)	(-55 to -3)	(± 2.0)	(± 1.5)	0.01
> 80 to 85	(-55 to -4)	(-55 to -4)	(± 2.0)	(± 1.5)	0.01
> 85 to 90	(-55 to -4)	(-55 to -4)	(± 2.0)	(± 1.5)	0.01
> 90 to 100	(-55 to 0)	(-55 to 0)	(± 3.0)	(± 2.0)	0.01
> 100 to 110	(-50 to -5)	(-50 to -5)	(± 3.0)	(± 2.0)	0.01

Corrected System Performance/Uncertainties – 3744E-EE/3744E-EW mmWave Modules

With 12-term Offset, Short, Sliding-Load, or LRL calibrations, using high precision waveguide sections and standards from the appropriate calibration kit.

3744E-EE Extended-E Band (WR-12) Waveguide – 56 GHz to 94 GHz

Calibration Type	Directivity [dB]	Source Match [dB]	Load Match [dB]	Reflection Tracking [dB]	Transmission Tracking [dB]
Offset Short	> 44	> 33	> 44	± 0.080	± 0.100
LRL	> 44	> 43	> 44	± 0.006	± 0.006

3744E-EW Extended-W Band (WR-10) Waveguide – 65 GHz to 110 GHz

Calibration Type	Directivity [dB]	Source Match [dB]	Load Match [dB]	Reflection Tracking [dB]	Transmission Tracking [dB]
Offset Short	> 40	> 30	> 46	± 0.080	± 0.100
LRL	> 40	> 40	> 46	± 0.006	± 0.006

Measurement Uncertainties – Extended-E Band – SSLT

The graphs give measurement uncertainties after the above calibration. The errors are worst case contribution of residual directivity, load and source match, frequency response and isolation, network analyzer dynamic accuracy, and connector repeatability. 10 Hz IF Bandwidth is used. For transmission uncertainties, it is assumed that $S_{11}=S_{22}=0$. For reflection uncertainties, it is assumed that $S_{21}=S_{12}=0$. All calibrations and measurements were performed at default port power. For other conditions, please use our free Exact Uncertainty Calculator software, available for download from the Anritsu web site at www.anritsu.com. The results below are typical.

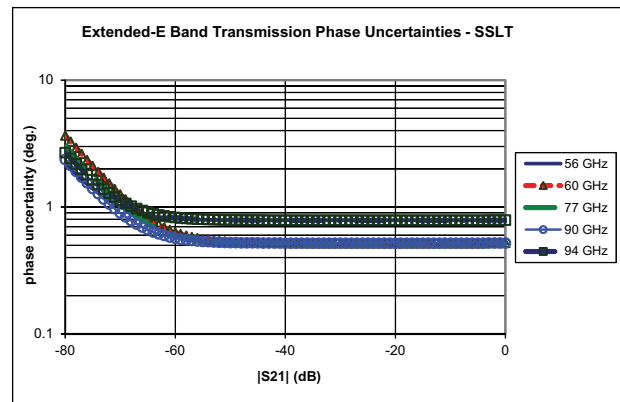
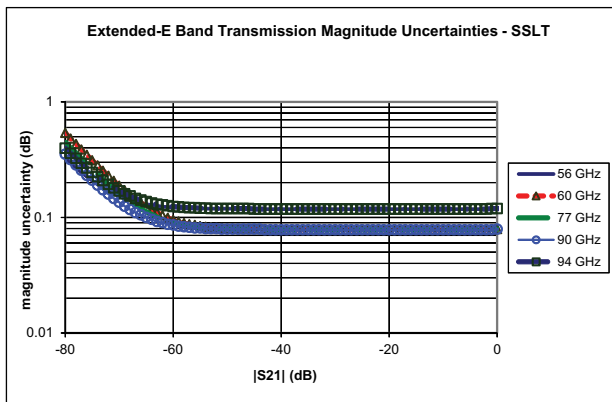
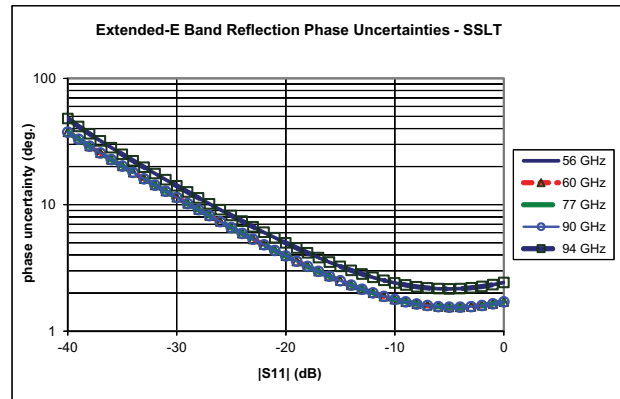
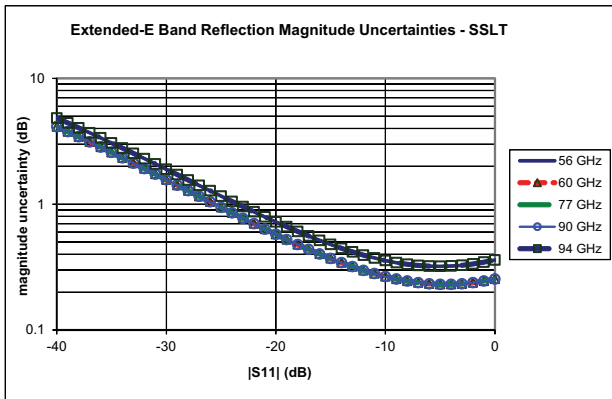

Measurement Uncertainties – Extended-E Band – LRL

The graphs give measurement uncertainties after the above calibration. The errors are worst case contribution of residual directivity, load and source match, frequency response and isolation, network analyzer dynamic accuracy, and connector repeatability. 10 Hz IF Bandwidth is used. For transmission uncertainties, it is assumed that $S_{11} = S_{22} = 0$. For reflection uncertainties, it is assumed that $S_{21} = S_{12} = 0$. All calibrations and measurements were performed at default port power. For other conditions, please use our free Exact Uncertainty Calculator software, available for download from the Anritsu web site at www.anritsu.com. The results below are typical.

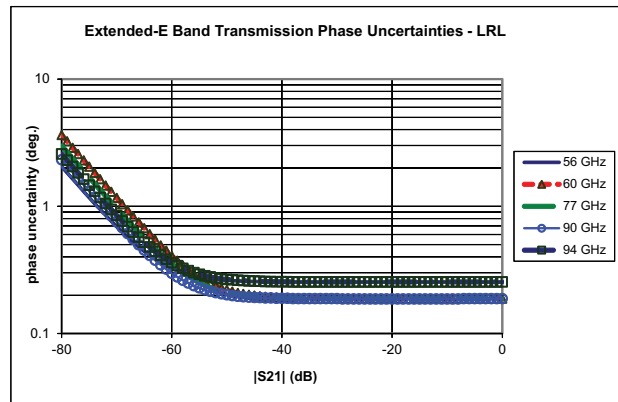
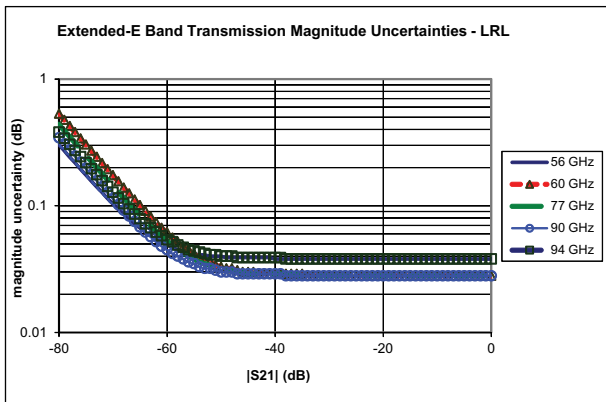
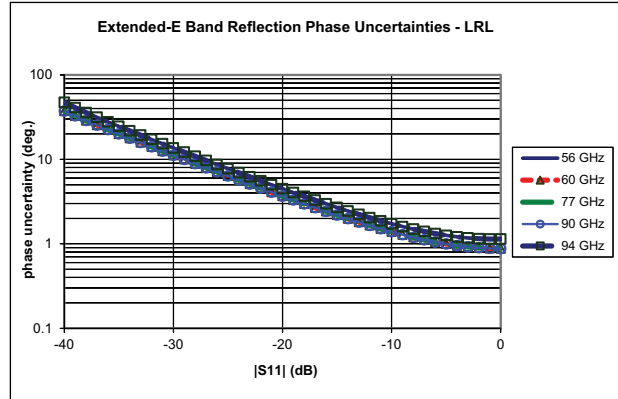
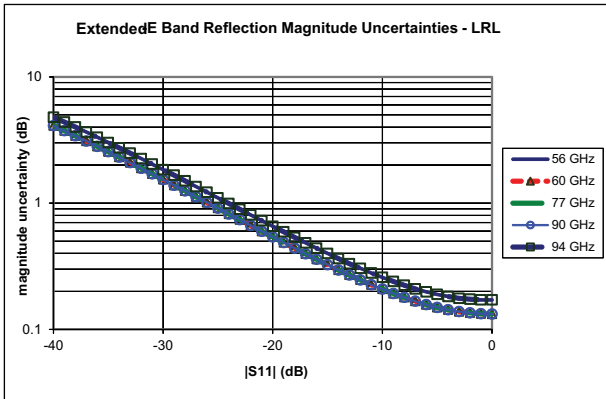

Measurement Uncertainties – Extended-W Band – SSLT

The graphs give measurement uncertainties after the above calibration. The errors are worst case contribution of residual directivity, load and source match, frequency response and isolation, network analyzer dynamic accuracy, and connector repeatability. 10 Hz IF Bandwidth is used. For transmission uncertainties, it is assumed that $S_{11}=S_{22}=0$. For reflection uncertainties, it is assumed that $S_{21}=S_{12}=0$. All calibrations and measurements were performed at default port power. For other conditions, please use our free Exact Uncertainty Calculator software, available for download from the Anritsu website at www.anritsu.com. The results below are typical.

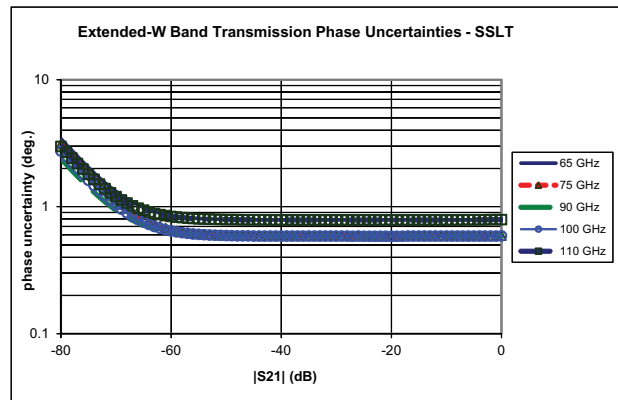
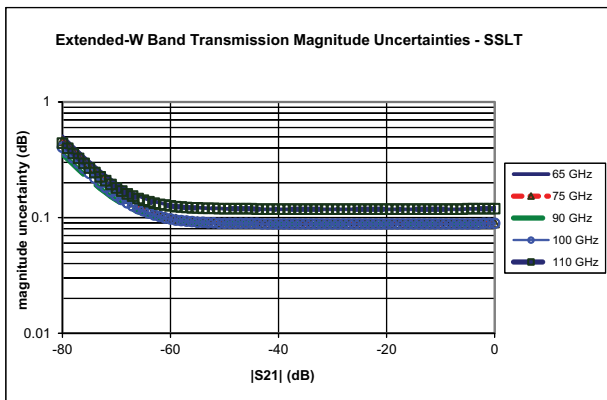
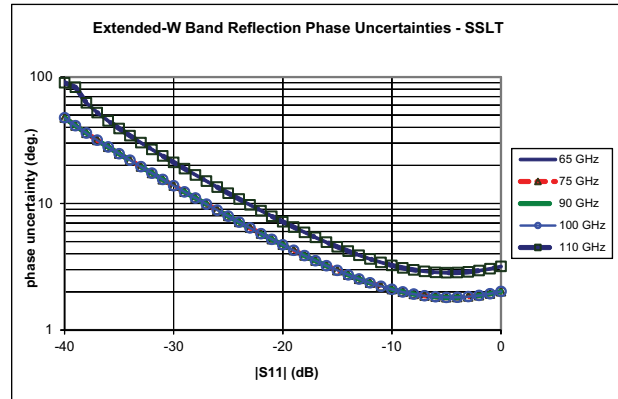
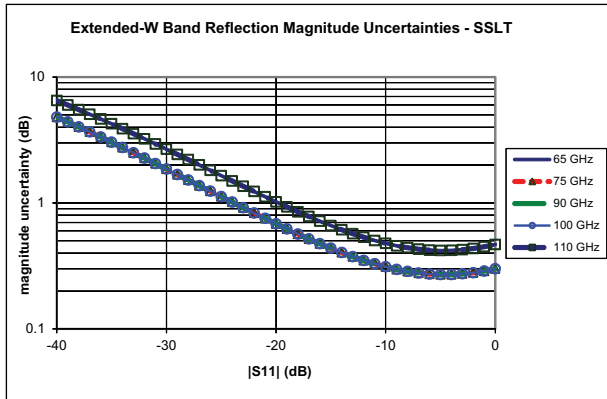

Measurement Uncertainties – Extended-W Band – LRL

The graphs give measurement uncertainties after the above calibration. The errors are worst case contribution of residual directivity, load and source match, frequency response and isolation, network analyzer dynamic accuracy, and connector repeatability. 10 Hz IF Bandwidth is used. For transmission uncertainties, it is assumed that $S_{11}=S_{22}=0$. For reflection uncertainties, it is assumed that $S_{21}=S_{12}=0$. All calibrations and measurements were performed at default port power. For other conditions, please use our free Exact Uncertainty Calculator software, available for download from the Anritsu website at www.anritsu.com. The results below are typical.

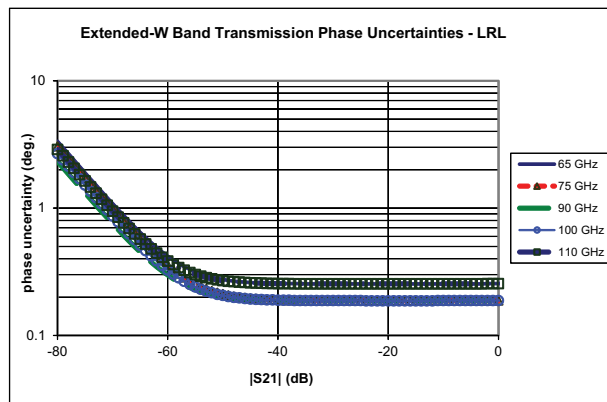
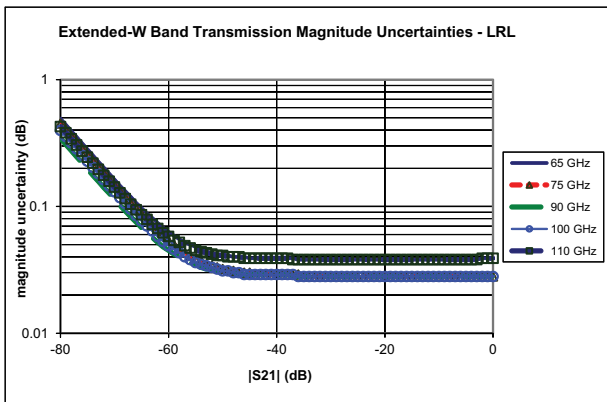
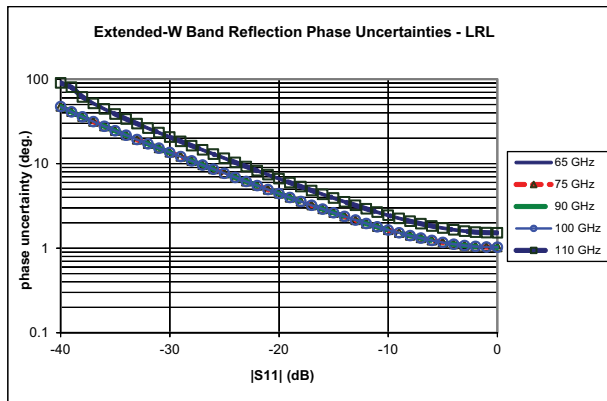
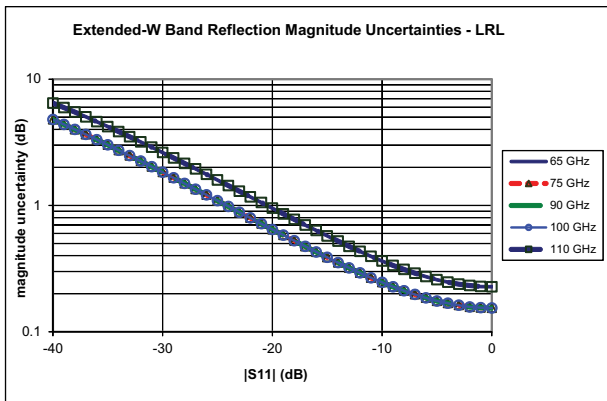

Millimeter-Wave Noise Figure Measurements with Option 41/48 and 3744E-Rx

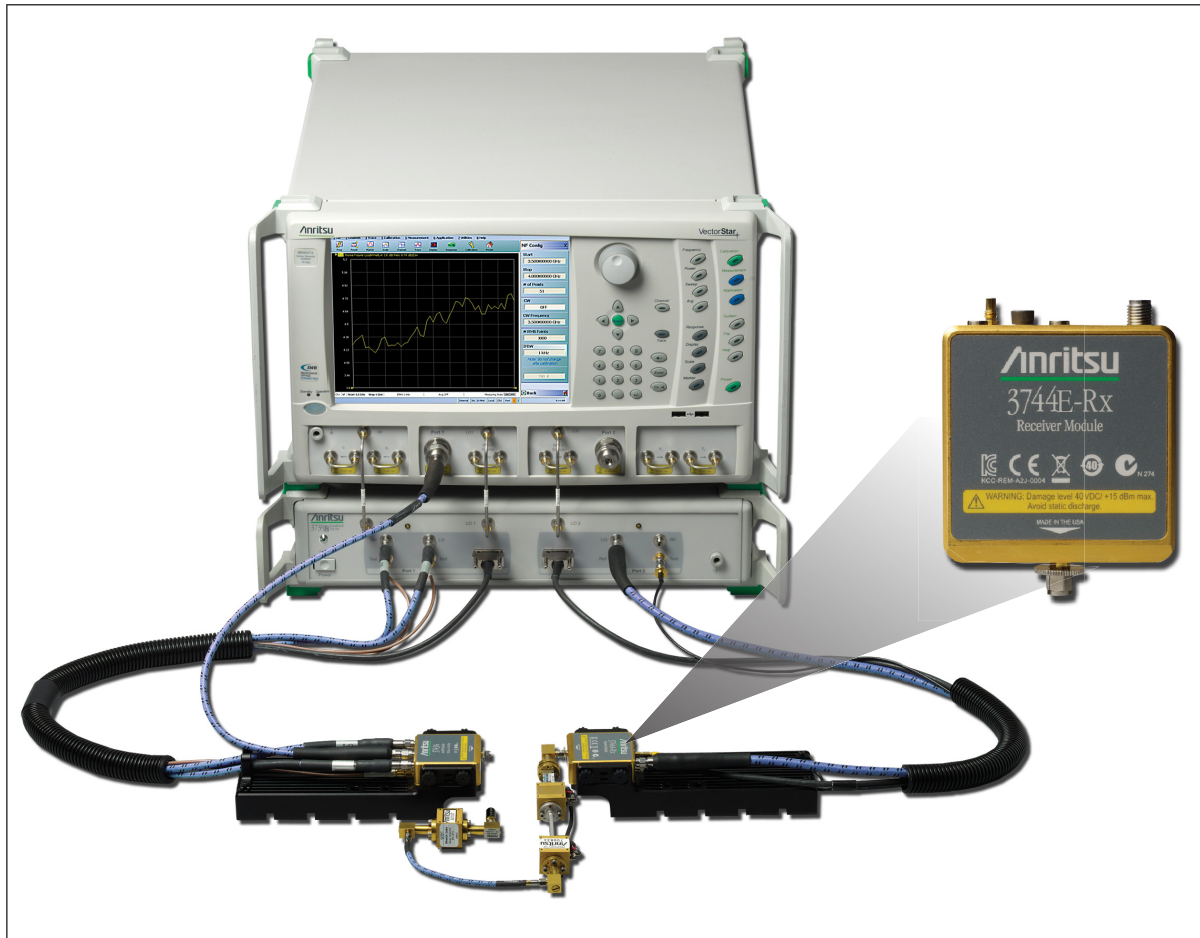

ME7838EX with 3744E-Rx Receiver Module

The 3744E-Rx receiver module can be used with Option 41, Noise Figure, and the ME7838EX mmWave or broadband system to perform mmWave noise figure measurements from 30 GHz to 110 GHz. The receiver bypasses the internal couplers (see block diagram on next page), maximizing the noise figure of the receiver for optimum noise figure measurement accuracy. The receiver is derived from the 3743EX mmWave module and utilizes the same nonlinear transmission line technology for optimum mmWave performance. Using the advantages of the 3743EX mmWave module system architecture provides a unique solution to mmWave noise figure measurements previously unavailable.

With Option 48, differential (and common-mode) noise figure measurements are possible in the same wide frequency ranges. In this case, two 3744A-Rx modules (along with needed pre-amplifiers/filters) are used to complete the differential receiver. While usually a 4-port system is used, a 2-port ME7838EX can be used for the noise measurements as long as DUT gain information is available.

Block Diagram – 3744E-Rx Receiver Module

As with all cold source method noise figure measurements, the output of the DUT is first sent to an external composite receiver for pre-amplification. This ensures that the system noise figure is minimized for optimum measurement accuracy. The Anritsu Noise Figure Uncertainty Calculator (available on the website at www.anritsu.com) can be used to determine optimum preamplifier gain needed for the desired measurement uncertainty.

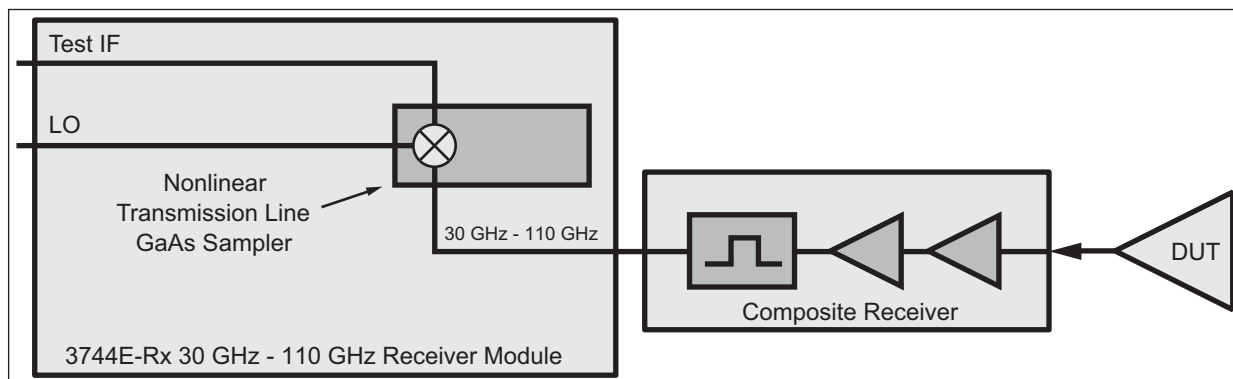

3744E-Rx Block Diagram

(Two composite receivers and two 3744A-Rx modules are used with Option 48 for differential or common-mode noise figure measurements.)

3744E-Rx Receiver Compression, Noise Floor

Receiver Compression Point is defined as the port power level beyond which the response may be compressed more than 0.2 dB relative to the normalization level. 10 Hz IF bandwidth is used to remove trace noise effects.

Noise Floor is relative to the receiver power calibration performed at -10 dBm.

Frequency Range	(Typical) [dBm]	
	Receiver Compression ^a	Noise Floor ^b
30 to 54 GHz	(0)	(-124)
54 to 60 GHz	(0)	(-122)
60 to 67 GHz	(0)	(-117)
67 to 80 GHz	(0)	(-120)
80 to 85 GHz	(0)	(-123)
85 to 90 GHz	(0)	(-121)
90 to 95 GHz	(0)	(-121)
95 to 105 GHz	(0)	(-117)
105 to 110 GHz	(0)	(-122)

a. At the 3744E-Rx test port.

b. Excludes localized spurious responses and crosstalk.

Waveguide Bands from 50 GHz to 1.1 THz

The VectorStar Millimeter-Wave system supports VDI modules starting at 50 GHz. System performance is based on the specific mmWave module installed and appropriate cal kit. The mmWave modules need to provide IF levels of -15 dBm to -5 dBm when the RF drive is set to maximum in order to deliver specified dynamic range. Contact the vendor web site for additional information.



VDI Millimeter-Wave Modules

VectorStar ME7838EX Millimeter-Wave System with VDI Modules

This section provides the specifications for the VectorStar MS4640B series microwave Vector Network Analyzers (VNAs) when configured with the Virginia Diodes, Inc. mmWave frequency extension modules. The following frequency bands are supported:

Waveguide Band	WR15	WR10	WR8.0	WR6.5	WR5.1	WR4.3	WR3.4	WR2.8	WR2.2	WR1.5	WR1.0 ^a
Frequency [GHz]	50 to 75	75 to 110	90 to 140	110 to 170	140 to 220	170 to 260	220 to 330	260 to 400	330 to 500	500 to 750	750 to 1100

a. Contact Anritsu

System Configuration with VDI Modules

The VectorStar Millimeter-Wave system provides control of VDI modules for frequency extension coverage up to 1.1 THz*. MS4640B series VectorStar VNA may be configured for mmWave operation by adding the appropriate control option and test set. System requirements include:

- VectorStar VNA Model: MS4642B, MS4644B, or MS4647B
(Note: For 1.1 THz operation the 40 GHz MS4644B or higher model is required.)
- Options: MS4640B Option 7, Receiver Offset
MS4640B Option 86, 87, 88, or 89
- Test Set: 3739C Test Set
- Cable: SM6537 Interface Cable – Connection between VectorStar and the VDI mmWave module is provided with this interface cable.
Each VDI module is equipped with a dedicated external power supply and DC cable.

VDI Module Performance with VectorStar

- Performance: Directivity values are valid when using appropriate VDI calibration kits. All extender heads include a precision Test Port. The performance values here are typical and subject to change. Extended and other frequency ranges may be available.
- Stability: Measured for 1 hour after a 1 hour system warm-up, in a stable environment with ideal cables.
- Dynamic Range: The dynamic range (RBW 10 Hz) is measured by first connecting two TxRx heads together and normalizing the un-calibrated S21 and S12. The heads are then disconnected and terminated with a waveguide short. The rms of the measured S21 & S12 give the system dynamic range.
- Test Port Power: Test Port Power is typical. Reduced power is possible at band edges.

VDI Extenders-Summary of Specifications (Typical)

Waveguide Band	WR15	WR12	WR10	WR8.0	WR6.5	WR5.1	WR4.3	WR3.4	WR2.8	WR2.2	WR1.5 ^a	WR1.0 ^a
Frequency Coverage [GHz]	50-75	60-90	75-110	90-140	110-170	140-220	170-260	220-330	260-400	330-500	500-750	750-1100
Dynamic Range BW = 10 Hz, [dB], (Typical)	120	120	120	120	120	120	115	115	100	110	100	65
Magnitude Stability [± dB]	0.1	0.1	0.1	0.15	0.25	0.25	0.3	0.3	0.5	0.5	0.4	0.5
Phase Stability [± deg.]	1.5	1.5	1.5	2	4	4	4	6	6	6	4	6
Test Port Power [dBm], (Typical)	13	18	18	16	13	6	4	1	-10	-3	-25	-30
Test Port Input Limit ^b [dBm, Saturation/Damage]	30	30	30	30	30	30	28	26	16	10	-3	-3
Directivity [dB]	30	30	30	30	30	30	30	30	30	30	30	30

a. Mini versions of these modules are available with higher port power and dynamic range.

b. Test Port Input Limits are shown for standard test port power models only.

VDI Module Head Configurations

TxRx	Transmitter with two receivers (reference and measurement), and two couplers. Two TxRx heads are required for full two-port measurements.
TxRef	Transmitter with reference receiver and one coupler.
Rx	Measurement receiver.
Tx	Transmitter.

VDI Module Options

Micrometer-Drive Variable Attenuator	A 0 dB to 30 dB micrometer-drive variable attenuator option is available on TxRx and Tx modules up through WR1.5. If ordered, "-Attn" is added as an option suffix to the module model number. The attenuators reduce TPP and DR by as much as 8 dB in the WR3.4 and higher frequency bands and add approximately 2 in to the enclosure.
Increased Test Port Power	Options exist for increasing test port power in some full bands or in partial bands. Consult factory for more information.
Non-Standard Frequency Bands	Non-standard frequency bands or other specific needs are possible. Consult factory for more information.
Custom Configuration	Anritsu/VDI will work with customers to reconfigure any extender to meet specific needs.

ME7838EX Measurement Examples Using VDI Millimeter-Wave Modules

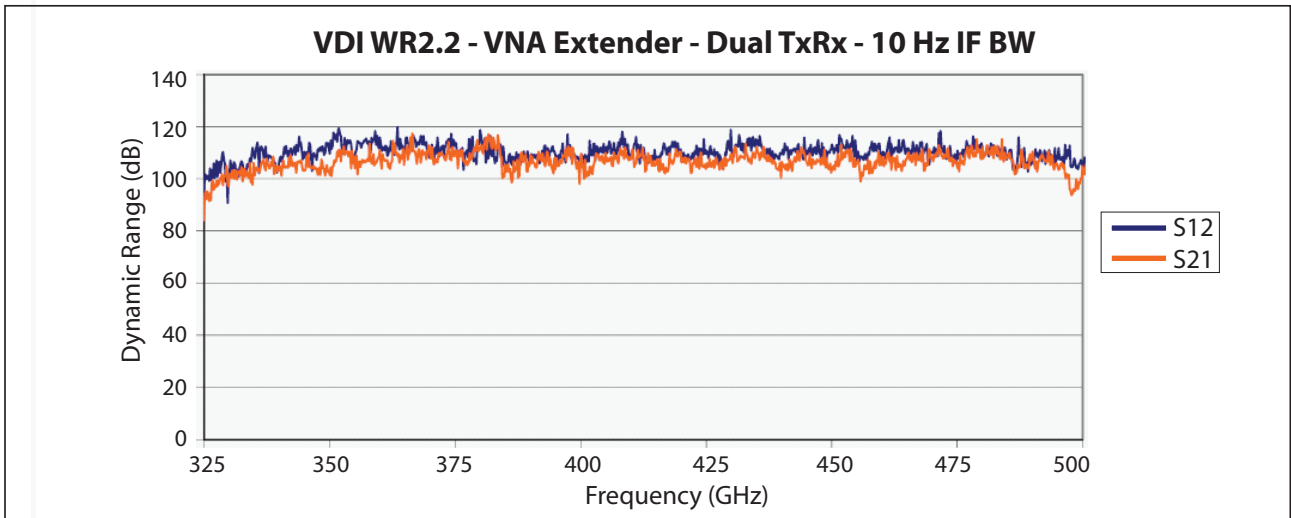

Typical Dynamic Range Plot of VDI WR2.2 Module - 10 Hz IFBW

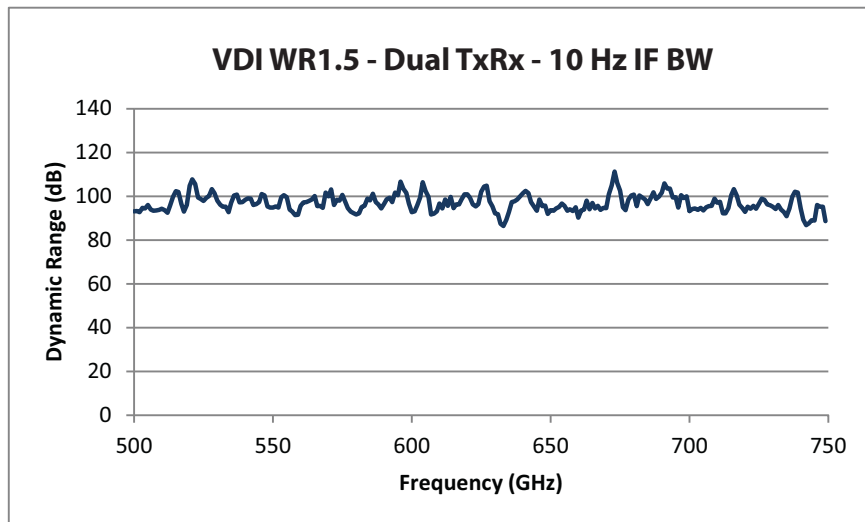

Typical Dynamic Range Plot of VDI WR1.5 Dual TxRx - 10 Hz IFBW

ME7838EX 400 GHz Power Sweep with VDI WR2.2 TxRx Module

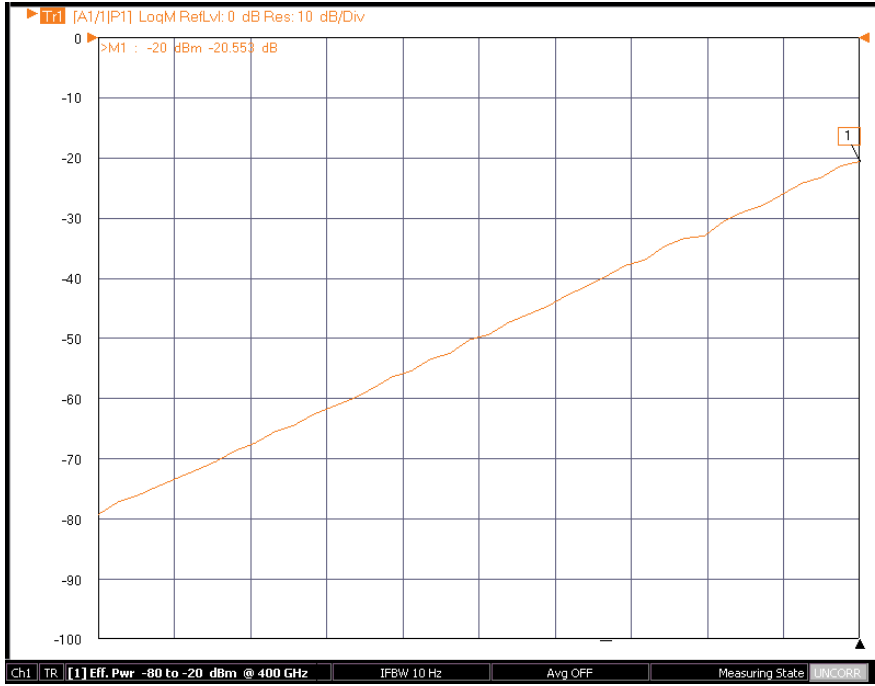

Typical real-time power sweep of VDI WR2.2 module using system power level control and no mechanical attenuators.

Standard Capabilities for All Configurations



Standard Capabilities for All Configurations

Mechanical and Environmental

MS4640B Vector Network Analyzer Dimensions without rack mount option.

Height	267 mm body (6u) 286 mm between feet outer edges
Width	426 mm body 457 mm between feet outer edges 487 mm between front panel handles outer edges
Depth	502 mm body 591 mm between handle and foot outer edges
Weight	< 28 kg (< 60 lbs), Typical weight for a fully-loaded MS4647B VNA

3739C Broadband/Millimeter-Wave Test Set Dimensions without rack mount option.

Height	89 mm body (2u) 108 mm between feet outer edges
Width	426 mm body 457 mm between feet outer edges 487 mm between front panel handles outer edges
Depth	502 mm body 591 mm between handle and foot outer edges
Weight	5.75 kg

3743EX Millimeter-Wave Module

Height	21.5 mm
Width	54 mm
Depth	55.3 mm
Weight	0.27 kg

Environmental – Operating Conforms to MIL-PRF-28800F (Class 3)

Temperature Range	0 °C to +50 °C without error codes (Except for ‘unleveled’ error messages that may occur at the extreme edges of the temperature range above.)
Relative Humidity	5 % to 95 % at +30 °C, Non-condensing
Altitude	4,600 m (15,000 feet)

Environmental – Non-Operating

Temperature Range	-40 °C to +71 °C
Relative Humidity	0 % to 90 % at +30 °C , Non-condensing
Altitude	4,600 m (15,000 feet)

Regulatory Compliance

European Union	EMC 2014/30/EU, EN 61326:2013, CISPR 11/EN 55011, IEC/EN 61000-4-2/3/4/5/6/8/11 Low Voltage Directive 2014/35/EU Safety EN 61010-1:2010 RoHS Directive 2011/65/EU & Amendment 2015/863
United Kingdom	EMC SI 2016/1091; BS EN 55011 & BS EN 61000-4-2/3/4/5/6/8/11 Consumer Protection (Safety) SI 2016/1101; BS EN 61010-1:2010 Environmental Protection SI 2012/3032; 2011/65/EU & 2015/863
Canada	ICES-1(A)/NMB-1(A)
Australia and New Zealand	RCM AS/NZS 4417:2012

Warranty

The ME7838EX Series and ME7838E4X VNAs offer a 1 year warranty from the date of shipment (excluding VDI modules). Please contact your local service center for additional warranty coverage.

Calibration and Correction Capabilities

Calibration Methods	<p>Short-Open-Load-Through (SOLT) with Fixed or Sliding Load and supporting .s1p-defined cal kits</p> <p>Offset-Short-Offset-Short-Load-Through (SSLT) with Fixed or Sliding Load</p> <p>Triple-Offset-Short-Through (SSST) and overdetermined offset short (mSSST)</p> <p>Short-Open-Load-Reciprocal (SOLR) or Unknown Through Method (SSLR, SSSR)</p> <p>Line-Reflect-Line (LRL) / Line-Reflect-Match (LRM) – (up to 5 bands supported for multi-line configurations)</p> <p>Advanced-LRM (A-LRM™) for improved on-wafer calibrations</p> <p>mTRL (Multiline TRL)</p> <p>AutoCal™</p> <p>Thru Update available</p> <p>Secondary match correction available for improved low insertion loss measurements</p>
Correction Models	<p>2-Port (Forward, Reverse, or both directions)</p> <p>1-Port (S_{11}, S_{22}, or both)</p> <p>Transmission Frequency Response (Forward, Reverse, or both directions)</p> <p>Reflection Frequency Response (S_{11}, S_{22}, or both)</p>
Merged Calibration	<p>Merge multiple calibration methods over bands of frequency points.</p> <p>Note that merge does not need to be used for broadband coaxial (SOLT/R-SSST/R) 1 mm or 0.8 mm calibrations using Anritsu calibration kits. These can be done as one unified calibration.</p>
Coefficients for Calibration Standards	<p>Use the Anritsu calibration kit USB Memory Device to load kit coefficients and characterization files.</p> <p>Enter manual coefficients into user-defined locations.</p> <p>Use complex load models.</p>
Reference Impedance	<p>Modify the reference impedance from 50 Ω to any impedance greater than 0 Ω.</p>
Interpolation	<p>Allows interpolation between calibration frequency points. Accuracy will be reduced at non-calibration frequencies and that degradation is dependent on the frequency step size in the initial calibration and the electrical length of the user's setup.</p>
Adapter Removal Calibration	<p>Characterizes and “removes” an adapter that is used during calibration that will not be used for subsequent device measurements; for accurate measurement of non-insertable devices.</p>
Dispersion Compensation	<p>Selectable as Coaxial, other non-dispersive (e.g., for coplanar waveguide), Waveguide, or Microstrip.</p>
Power	
Power Meter Correction	<p>Different power meter calibrations are available to enhance power accuracy at the desired reference plane. The source power will match the target calibration power, as read by the power meter, to within ~ 0.1 dB for short periods of time (determined by thermal drift of the system and the power meter). The absolute accuracy of the calibrated power will be dependent on the power meter and sensor used.</p>
Flat Power Calibrations	<p>A flat power calibration (when in frequency sweep mode) is available at a user-selectable power level, if it is within the power adjustment range of the internal source. The flat power correction is applied to other power levels directly as an offset. Multiple power meters/sensors may be needed depending on the frequency range. An adapter may be required to the 1mm module test port.</p>
Linear Power Calibrations	<p>A linear power calibration is performed over a range of power levels for use in power sweep mode and is performed at a specified frequency or frequency range (for multifrequency gain compression).</p>
External Power Meter	<p>Both calibrations are performed using an external power meter (Anritsu ML243xA, ML248xB, ML249xA, Agilent 437B (or equivalent), Keysight N191XA/EPM Series, Rhode and Schwarz NRP2 meter with a broadband 110 GHz sensor, or Elva DPM power meter) over the Dedicated GPIB port, or a USB power sensor (Anritsu MA24106A, MA24108A, MA24118A, MA24126A, MA24208A, MA24218A, MA24330A, MA24340A, MA24350A, or MA24507A, or Erickson PM5x meter) connected to a USB port.</p> <p>Note: Usage of the MA24500A series sensor requires a dual USB Type A male to single USB Type A female cable to supply needed current draw. Because of certain bandwidth requirements, the MA24500A series can only be used for power calibrations above nominally -35 dBm on VectorStar. Accuracy with the MA24500A series of sensors (when used with VectorStar) may be degraded below 1 MHz.</p>
Embedding/De-embedding	<p>The MS4640B is equipped with an Embedding/De-embedding system.</p>
De-embedding	<p>De-embedding is generally used for removal of test fixture contributions, modeled networks and other networks described by S-parameters (s2p files) from measurements.</p>
Embedding	<p>Similarly, the Embedding function can be used to simulate matching circuits for optimizing amplifier designs or simply adding effects of a known structure to a measurement.</p>
Multiple Networks	<p>Multiple networks can be embedded/de-embedded and changing the port and network orientations is handled easily.</p>
Extraction Utility	<p>An extraction utility is part of this package that allows the easier computation of de-embedding files based on some additional calibration steps and measurements.</p>
Impedance Conversion	<p>Allows entry of different impedances (complex values) for different ports.</p>

Mechanical Calibration/Verification Kits

W1 1 mm Calibration/Verification Kit, 3656C

Provides 12-term SOLT or Triple Offset Short calibrations, for W1 (1 mm) devices, and two verification standards. The standard 3656C and 3656C-3 kits include calibration and verification (18WWF50A-1 and -1B) components and verification characterization data. The 3656C-5 and 3656C-6 kits include only the calibration components. 3656C-3 and 3656C-6 kits have the calibration components defined with .s1p (tabular) files as well as with the model-based .ccf files.



3656C Cal Kit Contents	Additional Information (Typical)	Quantity	Part Number
Offset Short W1 (male)	Offset: 2.020 mm	1	23W50-1
Offset Short W1 (male)	Offset: 2.650 mm	1	23W50-2
Offset Short W1 (male)	Offset: 3.180 mm	1	23W50-5
Offset Short W1 (female)	Offset: 2.020 mm	1	23WF50-1
Offset Short W1 (female)	Offset: 2.650 mm	1	23WF50-2
Offset Short W1 (female)	Offset: 3.180 mm	1	23WF50-5
Open W1 (male)	Offset: 1.510 mm	1	24W50
Open W1 (female)	Offset: 1.930 mm	1	24WF50
Fixed Termination W1 (male)		1	28W50
Fixed Termination W1 (female)		1	28WF50
Adapter, W1 (male) to Fixed SC ^a Connector		1	33W5C50
Adapter, W1 (female) to Fixed SC ^a Connector		1	33WF5C50
Interchangeable Slider for SC ^a Connector (male)		1	-
Interchangeable Slider for SC ^a Connector (female)		1	-
Locking Keys for SC ^a Connectors		2	-
Pin Exchange Tool for SC ^a Connectors	Contains 1 male pin	1	01-402
Adapter, W1 (male) to W1 (female)		1	33WWF50-A
Adapter, W1 (male) to W1 (male)		1	33WW50-A
Adapter, W1 (female) to W1 (female)		1	33WFWF50-A
Stepped Impedance ThruLine, W1 (male - female)	Verification Device	1	18WWF50A-1B
50 Ohm matched ThruLine, W1 (male - female)	Verification Device	1	18WWF50A-1
Torque Wrench	6 mm, 5.4 N-cm (4 lbf-in)	1	01-504
Open-ended Wrench	6 mm / 7 mm	1	01-505
Coefficients for standards	On USB Memory Device	1	-

a. SC connectors are a solution for accurate calibrations for non-insertable 1 mm devices. Users can change the gender of the SC connector using the provided tool, pin, sliders, and locking keys to ensure the best pin-depth, thus calibrations are valid after changing the gender of the adapter.

Test Port Cables

Test Port Cables, Flexible, High Performance

Description	Frequency Range	Impedance	Length [cm]	Insertion Loss [dB]	Return Loss [dB]	Part Number
W1 (1 mm) (male) to W1 (1 mm) (female)	DC to 110 GHz	50 Ω	10	1.74	≥ 14	3671W1-50-1
			13	2.23	≥ 14	3671W1-50-2
			16	2.74	≥ 14	3671W1-50-3



3671W1-50-X Flexible Test Cables

3670.850-1, 3670.850-2

Description	Frequency Range	Impedance	Length [cm]	Insertion Loss [dB]	Return Loss [dB]	Part Number
1.0 mm (male) 1.0 mm (female)	DC to 110 GHz	50 Ω	10	(2.35 at 110 GHz)	>=18 dB under 15 GHz >=16 dB for 15-50 GHz >=12 dB for 50 to 110 GHz	3670W50-1
			16	(3.3 dB at 110 GHz)	>=18 dB under 15 GHz >=16 dB for 15-50 GHz >=12 dB for 50 to 110 GHz	3670W50-2



3670W50-X 1 mm Test Port Cables

Precision Adapters, Attenuators, and Other Components

Anritsu offers a complete line of precision adapters and attenuators. For more information, please visit our web site at www.anritsu.com.



Ordering Information

The ME7838EX Broadband/Millimeter-Wave VNA System provides single sweep coverage from 70 kHz to 110 GHz and consists of the following standard components and optional accessories described in the sections below:

ME7838EX Broadband System, 70 kHz to 110 GHz

Action	Part Number and Description	Additional Information
Order the base VectorStar model with the listed components and options:	MS4647B, 70 kHz to 70 GHz VNA MS4640B-007, Receiver Offset MS4640B-070, 70 kHz Frequency Coverage 3739C, Broadband Test Set with 36 inch interface cables 3743EX, Millimeter-Wave Module, 2 each ME7838EX-SS020, On-site system assembly and verification	
Include one of the following:	MS4647B-086, MS4647B with ME7838EX system option MS4647B-087, MS4647B with ME7838EX system option and Option 51, or 61, or 62	MS4647B-088 is ordered when Option 31 is included. MS4647B-089 is ordered when Option 31 is included.
Include one of the following:	806-206-R, 1.85 mm coaxial VNA RF cables, 24", M-F, 2 each 806-209-R, 1.85 mm coaxial VNA RF cables, 36", M-F, 2 each	
Add options if desired:	Option 51, or 61, or 62: MS4647B-051 – External VNA Loops MS4647B-061 – Active Measurement Suite, 2 Attenuators MS4647B-062 – Active Measurement Suite, 4 Attenuators MS4640B-070 – for 70 kHz operation in base VNA MS4640B-002 – for Time Domain MS4647B-031 – Dual Source Architecture MS4640B-035 – IF Digitizer MS4640B-041 – Noise Figure MS4640B-042 – PulseView™ MS4640B-043 – DifferentialView™ MS4640B-048 – Differential Noise Figure MS4640B-049 – Spectrum Analysis	MS4647B-031 requires Option 88 or 89. For other available options, see “ME7838EX/E4X Broadband/Millimeter-Wave System Options”
Calibration Options	ME7838EX-098 - Standard Calibration, ISO 17025 compliant, without data ME7838EX-099 - Premium Calibration, ISO 17025 compliant, with data	
Accessories	MS4640B-001, MS4640B Rack Mount 3739C-001, 3739C Rack Mount	

Broadband/Banded/Millimeter-Wave Extensions — Option 8x

- Option 80 Broadband/Millimeter-Wave. For broadband systems with a single-source VNA and without loop options (51, 61 or 62)
- Option 81 Broadband/Millimeter-Wave. For broadband systems with a single-source VNA and with a loop option.
- Option 82 Banded Millimeter-Wave Extension. For banded systems with a single-source VNA and without loop options (51, 61 or 62)
- Option 83 Millimeter-Wave Extension. For banded systems with a single-source VNA and with a loop option.
- Option 84 Broadband/Banded/Millimeter-Wave Extension. For systems with a dual-source VNA and without loop options (51, 61 or 62)
- Option 85 Broadband/Banded/Millimeter-Wave Extension. For systems with a dual-source VNA and with a loop option.
- Option 86 Broadband/Millimeter-Wave. For 110 GHz-limited broadband systems with a single-source VNA and without loop options (51, 61 or 62)
- Option 87 Broadband/Millimeter-Wave. For 110 GHz-limited broadband systems with a single-source VNA and with a loop option.
- Option 88 Broadband/Banded/Millimeter-Wave Extension. For 110 GHz-limited broadband systems with a dual-source VNA and without loop options (51, 61 or 62)
- Option 89 Broadband/Banded/Millimeter-Wave Extension. For 110 GHz-limited broadband systems with a dual-source VNAs and with a loop option.

ME7838EX Waveguide-Band System to 110 GHz – 3744E-EE or 3744E-EW mmWave Modules

Configuration for ME7838EX Millimeter-Wave System using 3744E-EE or 3744E-EW mmWave Modules:

Action	Part Number and Description	Additional Information
Choose and order one of the two base VectorStar models with options listed:	MS4644B VNA, 10 MHz to 40 GHz MS4640B-007, Receiver Offset MS4644B-086 or -087 or -088 or -089	MS4644B-087 is ordered when Option 51, or 61, or 62 is included. MS4644B-088 is ordered when Option 31 is included and Option 51, or 61, or 62 is <i>excluded</i> . MS4644B-089 is ordered when Option 31 <i>and</i> Option 51, or 61, or 62 is <i>included</i> .
	MS4647B VNA, 10 MHz to 70 GHz MS4640B-007, Receiver Offset MS4647B-086 or -087 or -088 or -089	MS4647B-087 is ordered when Options 51, 61, or 62 are included. MS4647B-088 is ordered when Option 31 is included and Option 51, or 61, or 62 is <i>excluded</i> . MS4647B-089 is ordered when Option 31 <i>and</i> Option 51, or 61, or 62 is <i>included</i> .
Order Test Set	3739C mmWave Test Set	
Choose and order Extended-E or Extended-W Band Modules:	3744A-EE, 56 GHz to 94 GHz Extended E Band module, 2 each	
	3744A-EW, 65 GHz to 110 GHz Extended W Band module, 2 each	
Add options if desired:	Option 51, or 61, or 62: MS464xB-051 – External VNA Loops MS464xB-061 – Active Measurement Suite, 2 Attenuators MS464xB-062 – Active Measurement Suite, 4 Attenuators	
	MS4640B-070 – for 70 kHz operation in base VNA MS4640B-002 – for Time Domain MS464xB-031 – Dual Source Architecture MS4640B-035 – IF Digitizer MS4640B-041 – Noise Figure MS4640B-042 – PulseView™ MS4640B-043 – DifferentialView™ MS4640B-048 – Differential Noise Figure MS4640B-049 – Spectrum Analysis	MS464xB-031 requires Option 88 or 89. For other available options, see “ME7838EX/E4X Broadband/Millimeter-Wave System Options”
	MS4640B-001, MS4640B Rack Mount 3739C-001, 3739C Rack Mount	
Accessories	35WR12WF-EE – Precision Waveguide to Coax Adapter Kit, 56 GHz to 94 GHz, WR-12 to W1 (f)	
	35WR10WF-EW – Precision Waveguide to Coax Adapter Kit, 65 GHz to 110 GHz, WR-10 to W1 (f)	

ME7838EX-Waveguide-Band System – VDI mmWave Modules

ME7838EX Waveguide-band System using VDI Millimeter-Wave modules:

Action	Part Number and Description	Additional Information
Choose and order one of the three base VectorStar models with options listed:	MS4642B VNA, 10 MHz to 20 GHz MS4640B-007, Receiver Offset MS4642B-061 or MS4642B-062 MS4642B-087 or MS4642B-089	MS4642B-061 includes Active Device Measurements, with 2-Step Attenuators MS4642B-062 includes Active Device Measurements, with 4-Step Attenuators MS4642B-089 is ordered when Option 31 is included.
	MS4644B VNA, 10 MHz to 40 GHz MS4640B-007, Receiver Offset MS4644B-086 or -087 or -088 or -089	MS4644B-087 is ordered when Options 51, 61, or 62 are included. MS4644B-088 is ordered when Option 31 is included and Option 51, or 61, or 62 is <i>excluded</i> . MS4644B-089 is ordered when Option 31 <i>and</i> Option 51, or 61, or 62 is <i>included</i> .
	MS4647B VNA, 10 MHz to 70 GHz MS4640B-007, Receiver Offset MS4647B-086 or -087 or -088 or -089	MS4647B-087 is ordered when Options 51, 61, or 62 are included. MS4647B-088 is ordered when Option 31 is <i>included</i> and Option 51, or 61, or 62 is <i>excluded</i> . MS4647B-089 is ordered when Option 31 <i>and</i> Option 51, or 61, or 62 is <i>included</i> .
Order:	3739C mmWave Test Set	
	SM6537 Interface Cables (2) for VDI mmWave Modules	Does not include DC cable. DC supply is provided by mmWave module power supply.
Choose and order one of the two appropriate millimeter-wave module combinations:	2 each TxRx transmission and reflection millimeter-wave modules	Choose appropriate VDI modules. Contact Anritsu Company for ordering information.
	1 each TxRx transmission and reflection module, and 1 each Tx transmission only module	
Add options if desired:	Option 51, or 61, or 62: MS464xB-051 – External VNA Loops MS464xB-061 – Active Measurement Suite, 2 Attenuators MS464xB-062 – Active Measurement Suite, 4 Attenuators	
	MS4640B-070 – for 70 kHz operation in base VNA MS4640B-002 – for Time Domain MS464xB-031 – Dual Source Architecture MS4640B-035 – IF Digitizer MS4640B-041 – Noise Figure MS4640B-042 – PulseView™ MS4640B-043 – DifferentialView™ MS4640B-048 – Differential Noise Figure MS4640B-049 – Spectrum Analysis	MS464xB-031 requires Option 88 or 89. For other available options, see “ME7838EX/E4X Broadband/Millimeter-Wave System Options”

The ME7838E4X 4-Port Broadband/Millimeter-Wave VNA System provides single sweep coverage from 70 kHz to 110 GHz and consists of the following standard components and optional accessories described in the sections below:

ME7838E4X 4-Port Broadband System, 70 kHz to 110 GHz

Action	Part Number and Description	Additional Information
Order the base VectorStar model with the listed components and options:	MS4647B, 70 kHz to 70 GHz VNA MS4640B-007, Receiver Offset MS4640B-070, 70 kHz frequency coverage MN4697C, 4-Port Test Set 3739C, Broadband Test Set with 36 inch interface cables 3736B Broadband/Millimeter-Wave Test Set 3743EX, Millimeter-Wave Module, 4 each 806-209-R, 1.85mm coaxial VNA RF cables, 36 in, (m-f) 4 each ME7838E4X-SS020, On-site system assembly and verification	MS4647B-089 is ordered when Option 31 is included.
Include the following:	MS4647B-087, MS4647B with ME7838E4X system option and Option 51, or 61, or 62: MS4647B-051 – External VNA Loops MS4647B-061 – Active Measurement Suite, 2 Attenuators MS4647B-062 – Active Measurement Suite, 4 Attenuators	
Add options if desired	MS4640B-070 – for 70 kHz operation in base VNA MS4640B-002 – for Time Domain MS4647B-031 – Dual Source Architecture MS4640B-035 – IF Digitizer MS4640B-041 – Noise Figure MS4640B-042 – PulseView™ MS4640B-043 – DifferentialView™ MS4640B-044 – IMDView™ MS4640B-048 – Differential Noise Figure MS464xB-049 – Spectrum Analysis	MS4647B-031 requires Option 89 For other available options, see “ME7838EX/E4X Broadband/Millimeter-Wave System Options”

ME7838E4X 4-Port Waveguide-Band System to 110 GHz – 3744E-EE or 3744E-EW mmWave Modules

Configurator for ME7838E4X Millimeter-Wave System using 3744E-EE or 3744E-EW mmWave Modules:

Action	Part Number and Description	Additional Information
Choose and order one of the two base VectorStar models with options listed:	MS4644B VNA, 10 MHz to 40 GHz MS4640B-007, Receiver Offset MS4644B-087 or MS4644B-089	MS4644B-089 is ordered when Option 31 is included.
	MS4647B VNA, 10 MHz to 70 GHz MS4640B-007, Receiver Offset MS4647B-087 or MS4647B-089	MS4647B-089 is ordered when Option 31 is included.
Order:	MN4697C, 4-Port Test Set 3736B Broadband/Millimeter-Wave Test Set 3739C Broadband/Millimeter-Wave Test Set	
Choose and order Extended-E or Extended-W Band Modules:	3744E-EE, 56 GHz to 94 GHz Extended E Band module, 4 each 3744E-EW, 65 GHz to 110 GHz Extended W Band module, 4 each	
Order one of the following:	Option 51, or 61, or 62: MS464xB-051 – External VNA Loops MS464xB-061 – Active Measurement Suite, 2 Attenuators MS464xB-062 – Active Measurement Suite, 4 Attenuators	ME7838E4X requires Option 51, or 61, or 62
Add options if desired:	MS4640B-070 – for 70 kHz operation in base VNA MS4640B-002 – for Time Domain MS464xB-031 – Dual Source Architecture MS4640B-035 – IF Digitizer MS4640B-041 – Noise Figure MS4640B-042 – PulseView™ MS4640B-043 – DifferentialView™ MS4640B-048 – Differential Noise Figure MS464xB-049 – Spectrum Analysis	MS464xB-031 requires Option 89 For other available options, see “ME7838EX/E4X Broadband/Millimeter-Wave System Options”
Accessories	35WR12WF-EE – Precision Waveguide to Coax Adapter Kit, 56 GHz to 94 GHz, WR-12 to W1 (f)	
	35WR10WF-EW – Precision Waveguide to Coax Adapter Kit, 65 GHz to 110 GHz, WR-10 to W1 (f)	

Calibration/Verification Kits

3656C	W1 (1 mm) Calibration/Verification Kit
3656C-3	W1 (1 mm) Calibration/Verification Kit, With .s1p Standard Definitions Files
3656C-5	W1 (1 mm) Calibration Kit
3656C-6	W1 (1 mm) Calibration Kit, With .s1p Characterization Files
3655V	WR-15 Waveguide Calibration Kit, Without Sliding Loads
3655V-1	WR-15 Waveguide Calibration Kit, With Sliding Loads
3655E	WR-12 Waveguide Calibration Kit, Without Sliding Loads
3655E-1	WR-12 Waveguide Calibration Kit, With Sliding Loads
3655W	WR-10 Waveguide Calibration Kit, Without Sliding Loads
3655W-1	WR-10 Waveguide Calibration Kit, With Sliding Loads
3650A	SMA/3.5 mm Calibration Kit, Without Sliding Loads
3652A	K Calibration Kit, With Pin Depth Gauge
3652A-2	K Calibration Kit, With No Pin Depth Gauge
3652A-3	K Calibration Kit, With Pin Depth Gauge and .s1p Characterization Files
3652A-4	K Calibration Kit, With .s1p Characterization Files
3654D	V Calibration Kit, With Pin Depth Gauge
3654D-2	V Calibration Kit, With No Pin Depth Gauge
3654D-3	V Calibration Kit, With Pin Depth Gauge and .s1p Characterization Files
3654D-4	V Calibration Kit, With .s1p Characterization Files

External Power Meters/Sensors

ML243xA	CW Power Meter, Single Input or Dual Input Recommended Power Sensors: SC7770, MA247xD, MA244xD, MA248xD, MA2400xA
ML248xB	Wideband Power Meter, Single Input or Dual Input Recommended Power Sensors: MA249xA, MA2411B
ML249xA	Pulse Power Meter, Single Input or Dual Input Recommended Power Sensors: MA249xA, MA2411B
MA24106A	USB Power Sensor, 50 MHz to 6 GHz
MA24108A	USB Power Sensor, 10 MHz to 8 GHz
MA24118A	USB Power Sensor, 10 MHz to 18 GHz
MA24126A	USB Power Sensor, 10 MHz to 26 GHz
MA24330A	USB Power Sensor, 10 MHz to 33 GHz
MA24340A	USB Power Sensor, 10 MHz to 40 GHz
MA24350A	USB Power Sensor, 10 MHz to 50 GHz
MA24507A	Power Master™ Frequency Selectable mmWave Power Analyzer, 9 kHz to 70 GHz
MA24510A	Power Master™ Frequency Selectable mmWave Power Analyzer, 9 kHz to 110 GHz Note that usage of the MA24507A or MA24510A Power Master™ sensor requires connection to two USB ports to supply needed current draw.

Test Port Cables, Flexible, High Performance

3670W50-1	DC to 110 GHz, W1(m) to W1(f), 10.0 cm
3670W50-2	DC to 110 GHz, W1(m) to W1(f), 16.0 cm
3671W1-50-1	W1 (male) to W1 (female), 1 each, 10.0 cm (3.9 in)
3671W1-50-2	W1 (male) to W1 (female), 1 each, 13.0 cm (5.1 in)
3671W1-50-3	W1 (male) to W1 (female), 1 each, 16.0 cm (6.3 in)
3671KFS50-60	K (female) to 3.5 mm (male) cable, 60 cm (one cable)
3671KFK50-60	K (female) to K (male) cable, 60 cm (one cable)
3671KFK50-100	K (female) to K (male) cable, 1 each, 100 cm (one cable)
3671KFK50-60	K (female) to K (female) cable, 1 each, 60 cm (one cable)
3671VVF50-60	V (female) to V (male) cable, 1 each, 60 cm (one cable)
3671VVF50-100	V (female) to V (male) cable, 1 each, 100 cm (one cable)
3671KFSF50-60	K (female) to 3.5 mm (female) cable, 1 each, 60 cm (one cable)
3671VVF50-60	V (female) to V (female) cable, 1 each, 60 cm (one cable)

Adapters

34WV50	W1 (male) to V (male) Adapter, W1 (1 mm) to V, Coaxial
34WVF50	W1 (male) to V (female) Adapter, W1 (1 mm) to V, Coaxial
34WVF50	W1 (female) to V (male) Adapter, W1 (1 mm) to V, Coaxial
34WVVF50	W1 (female) to V (female) Adapter, W1 (1 mm) to V, Coaxial
33WW50A	W1 (male) to W1 (male) Adapter, W1 (1 mm) in-series, Coaxial
33WVVF50A	W1 (male) to W1 (female) Adapter, W1 (1 mm) in-series, Coaxial
33WVVF50A	W1 (female) to W1 (female) Adapter, W1 (1 mm) in-series, Coaxial
35WR10W	WR10 to W1 (male) Adapter, W1 (1mm) to WR10 Waveguide
35WR10WF	WR10 to W1 (female) Adapter, W1 (1mm) to WR10 Waveguide
SC7260	WR12 to W1 (male) Adapter, W1 (1 mm) to WR12 Waveguide
SC7442	WR12 to W1 (female) Adapter, W1 (1 mm) to WR12 Waveguide
35WR15V	WR15 to V (male) Adapter, V (1.85mm) to WR15 Waveguide
35WR15VF	WR15 to V (female) Adapter, V (1.85mm) to WR15 Waveguide
For More Information	Refer to our Precision RF & Microwave Components Catalog for descriptions of adapters and other components.

Miscellaneous Components

41W-3	Attenuator, DC to 110 GHz, 0.2 W, 3 dB, W1(m) to W1(f), 50 Ω
41W-6	Attenuator, DC to 110 GHz, 0.2 W, 6 dB, W1(m) to W1(f), 50 Ω
41W-10	Attenuator, DC to 110 GHz, 0.2 W, 10 dB, W1(m) to W1(f), 50 Ω
W240A	Precision Power Divider, DC to 110 GHz, W1(f) input, W1(f) outputs, 3 resistor, 50 Ω
W241A	Precision Power Splitter, DC to 110 GHz, W1(m) input, W1(f) outputs, 2 resistor, 50 Ω
MN25110A	Precision Directional Coupler, 20 GHz to 110 GHz, W1(f) input, W1(f) output, W1(f) coupled port, 50 Ω

Accessories

SC8215	Kelvin Bias Tee, low frequency limit: 70 kHz, Max Voltage: 16 VDC, Max Current: 100 mA
SC7287	Kelvin Bias Tee, low frequency limit: 100 MHz, Max Voltage: 50 VDC, Max Current: 500 mA
SC8218	Triax (male) to SMC (female) Cable, (Inner-shield floating at SMC end), 1.5 m (60 in) long two (2) needed per Kelvin Bias Tee
SM6494	System floor console. Includes larger size writing table
2100-2-R	GPIB cable, 2 m (79 in) long
2100-4-R	GPIB cable, 4 m (157 in) long
806-206-R	Flexible Coaxial Cable, DC to 70 GHz, 24 in (61 cm), V(m) – V(f), 50Ω for connecting the VNA and the 3743A Modules
806-209-R	Flexible Coaxial Cable, DC to 70 GHz, 36 in (91.5 cm), V(m) – V(f), 50Ω for connecting the VNA and the 3743A Modules
01-201	Torque Wrench (for tightening male devices), 8 mm (5/16 in), 0.9 N·m (8 lbf·in) for SMA, 3.5 mm, 2.4 mm, K, and V connectors
01-202	Universal Test Port Connector Wrench
01-203	Torque Wrench (for tightening the VNA test ports to female devices) 20.6 mm (13/16 in), 0.9 N·m (8 lbf·in)
01-204	Anritsu Stainless Steel Connector Wrench, circular, open-ended for SMA, 3.5 mm, 2.4 mm, K and V connectors
01-504	Torque wrench (for tightening male devices) 6 mm, 0.45 N·m (4 lbf·in) for 1.0 mm and 0.8 mm connectors
01-524	Low profile Torque Wrench (for tightening male devices), 6 mm, 0.45 N·m (4 lbf·in), 126 mm long for 1.0 mm and 0.8 mm connectors

Documentation

User Documentation:	All manuals are available as free downloads at www.anritsu.com .
10410-00317	MS4640B Series VNA Operation Manual (OM)
10410-00318	MS4640B Series VNA Calibration and Measurement Guide (MG)
10410-00319	MS4640B Series VNA User Interface Reference Manual (UIRM)
10410-00320	MS4640B Series VNA Maintenance Manual (MM)
10410-00322	MS4640B Series VNA Programming Manual (PM), for IEEE 488.2, System, and SCPI Commands
10410-00323	MS4640B Series VNA Programming Manual Supplement (PMS), for Lightning 37xxxx and HP8510 Emulation
10410-00771	ME7838E4/E4X Quick Start Guide
11410-02827	ME7838EX/E4X-VectorStar-TDS

Training at Anritsu

Anritsu has designed courses to help you stay up to date with technologies important to your job. For available training courses, visit: www.anritsu.com and search for training and education.



• United States

Anritsu Americas Sales Company

490 Jarvis Drive, Morgan Hill, CA 95037-2809, U.S.A.
Phone: +1-800-Anritsu (1-800-267-4878)

• Canada

Anritsu Electronics Ltd.

Americas Sales and Support

490 Jarvis Drive, Morgan Hill, CA 95037-2809, U.S.A.
Phone: +1-800-Anritsu (1-800-267-4878)

• Brazil

Anritsu Eletronica Ltda.

Praça Amadeu Amaral, 27 - 1 Andar
01327-010 - Bela Vista - Sao Paulo - SP, Brazil
Phone: +55-11-3283-2511
Fax: +55-11-3288-6940

• Mexico

Anritsu Company, S.A. de C.V.

Blvd Miguel de Cervantes Saavedra #169 Piso 1,
Col. Granada, Mexico, Ciudad de Mexico,
11520, MEXICO
Phone: +52-55-4169-7104

• United Kingdom

Anritsu EMEA Limited

900 Capability Green,
Luton, Bedfordshire, LU1 3LU, U.K.
Phone: +44-1582-433200
Fax: +44-1582-731303

• France

Anritsu SA

12 avenue du Québec, Immeuble Goyave,
91140 VILLEBON SUR YVETTE, France
Phone: +33-1-60-92-15-50

• Germany

Anritsu GmbH

Nemetschek Haus, Konrad-Zuse-Platz 1,
81829 München, Germany
Phone: +49-89-442308-0
Fax: +49-89-442308-55

• Italy

Anritsu S.R.L.

Spaces Eur Arte, Viale dell'Arte 25, 00144 Roma, Italy
Phone: +39-6-509-9711

• Sweden

Anritsu AB

Kistagången 20 B, 2 tr, 164 40 Kista, Sweden
Phone: +46-8-534-707-00

• Finland

Anritsu AB

Technopolis Aviapolis, Teknobulevardi 3-5 (D208.5.),
FI-01530 Vantaa, Finland
Phone: +358-20-741-8100

• Denmark

Anritsu A/S

c/o Regus Winghouse, Ørestads Boulevard 73, 4th floor,
2300 Copenhagen S, Denmark
Phone: +45-7211-2200

• Spain

Anritsu EMEA Ltd.

Representation Office in Spain

Calle Manzanares 4, Primera planta, 28005
Madrid, Spain
Phone: +34-91-572-6761

• Austria

Anritsu Pty Ltd

Am Belvedere 10, A-1100 Vienna, Austria
Phone: +43-(0)1-717-28-710

• United Arab Emirates

Anritsu EMEA Ltd.

Anritsu A/S

Office No. 164, Building 17, Dubai Internet City
P. O. Box – 501901, Dubai, United Arab Emirates
Phone: +971-4-3758479

• India

ANRITSU INDIA PRIVATE LIMITED

6th Floor, Indiqube ETA, No.38/4, Adjacent to EMC2,
Doddanekundi, Outer Ring Road,
Bengaluru – 560048, India
Phone: +91-80-6728-1300
Fax: +91-80-6728-1301

• Singapore

ANRITSU PTE LTD

1 Jalan Kilang Timor, #07-04/06 Pacific Tech Centre
Singapore 159303
Phone: +65-6282-2400
Fax: +65-6282-2533

• Vietnam

ANRITSU COMPANY LIMITED

16th Floor, Peakview Tower, 36 Hoang Cau Street,
O Cho Dua Ward, Dong Da District, Hanoi, Vietnam
Phone: +84-24-3201-2730
Fax: +84-24-3201-2740

• P.R. China (Shanghai)

Anritsu (China) Co., Ltd.

Room 2701-2705, Tower A, New Caohejing
International Business Center No. 391 Gui Ping Road
Shanghai, 200233, P.R. China
Phone: +86-21-6237-0898
Fax: +86-21-6237-0899

• P.R. China (Hong Kong)

ANRITSU COMPANY LIMITED

Unit 1302, 13th Floor, New East Ocean Center,
No.9 Science Museum Road, TsimShaTsui East,
Kowloon, Hong Kong
Phone: +852-2301-4980
Fax: +852-2301-3545

• Japan

Anritsu Corporation

8-5, Tamura-cho, Atsugi-shi, Kanagawa, 243-0016 Japan
Phone: +81-46-296-6509
Fax: +81-46-225-8352

• South Korea

Anritsu Corporation, Limited

8F, A TOWER, 20, Gwacheondaero 7-gil, Gwacheon-si,
Gyeonggi-do, 13840, Republic of Korea
Phone: +82-2-6259-7300
Fax: +82-2-6259-7301

• Australia

Anritsu Pty. Ltd.

Unit 20, 21-35 Ricketts Road,
Mount Waverley, Victoria 3149, Australia
Phone: +61-3-9558-8177
Fax: +61-3-9558-8255

• Taiwan

ANRITSU COMPANY, INC.

7F, No. 316, Sec. 1, NeiHu Rd., Taipei 114, Taiwan
Phone: +886-2-8751-1816
Fax: +886-2-8751-1817

List Revision Date: 20250812